



bir damla sanat

1982 yılında kurulmuş olan firma; su armatürleri üretim ve satışını gerçekleştirmekte olup, 1995 yılından günümüze, gelişen iş ağı ile müşteri taleplerini karşılayabilmek ve en iyi hizmeti sunabilmek için markalaşma yoluna gitmiştir.

Firma markalaşmanın ilk adımını 1995 yılında **ACESER** markası ile su armatürleri üretimine geçerek başlamıştır. Halen İstanbul Sancaktepe'deki genel merkezinin yer aldığı İdare binası ve Ataşehir Ferhatpaşa'da bulunan fabrikasında üretim faaliyetlerini sürdürmektedir.

#### **ACESER** markasıyla

Mutfak-Banyo Armatür ve Aksesuarları konusunda uzmanlaşmış olan firma dünya standartlarında üretim kalitesiyle, müşteri beklenti ve memnuniyetlerinin ön planda tutulduğu ve karşılandığı hizmet anlayışıyla, sektöründe Türkiye ve dünya pazarında önemli bir konuma gelmiştir.

Her geçen gün bu yükselişini daha da ileriye taşıyan **ACESER** gelişen ve değişen teknolojiyi takip ederek üretimlerini günün ihtiyaçlarına göre sürekli yenileyerek ürün çeşitliliğini de arttırmaktadır.

**ACESER**'in uyguladığı yönetim sistemi ve uzun soluklu çalışmalar sonunda, zorlu test süreçlerinden geçerek oluşturduğu ürün yelpazesi; Uluslararası Kalite Belgelendirme Kuruluşları tarafından ISO 9001, TS EN 200, TS EN 817 sertifikalarıyla belgelendirilmiştir. Tüm **ACESER** ürünleri 5 yıl garanti belgesine sahiptir.

**ACESER**; alanında uzman, yenilikleri ve gelişmeleri ürünlerine adapte edinmeyi ilke edinmiş kadrosuyla, kaliteli ürün ve hizmet anlayışını değerli müşterilerine sunmaya devam edecektir.

Our company carries out the manufacture and sale of water fixtures since 1982. As of 1995, to meet the demands of customers with thriving business an in order to give the best service, it embarked on a path of branding

Our company taking its first steps of branding as called **ACESER**, started the production of water fixtures in 1995. Our company has two different working places both in Sancaktepe as a General Management Building and in Ataşehir (Ferhatpaşa) as the factory of producing the water fixtures.

With the brand of **ACESER**;

- Kitchen Fixtures,
- Bath Fixtures,

- Our company which specializes in kitchen and bathroom fixtures has the important figure both in world's marketing and in Turkey by keeping customers satisfaction in the forefront, world-class production quality, contemporary, leading to innovations in the sector.

Ever day, we carry on rising further and further. By following the developing and changing technology, we have been constantly developing our products diversity by renewing according to the needs of the day.

As a result of implementing its management system and long-term studies, **ACESER** has made in products which formed by passing rigorous testing processes authenticated by ISO 9001, TS EN 200, TS EN 817 sertifikalarıyla belgelendirilmiştir. All **ACESER** products have a 5 year warranty.

Our personnel, who are committed to innovation adapting to product development as experts in their field with the principles of quality products and quality service, are going to continue to provide better quality and faster services for our valuable customers.

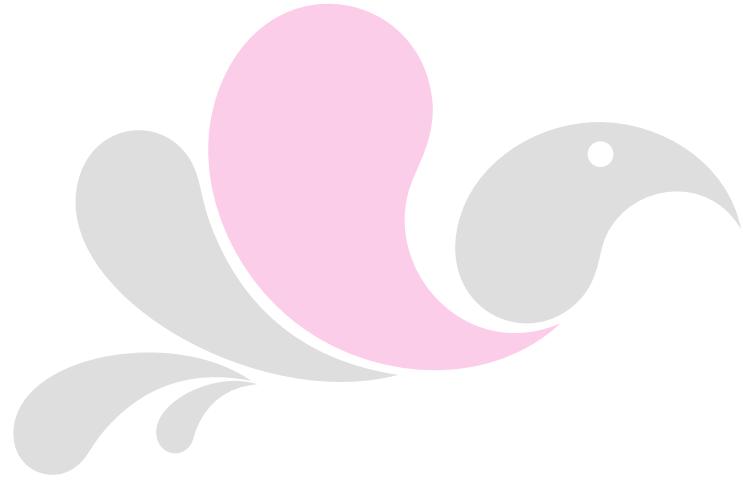

**DİLARA SERİSİ**  
*DILARA SERIES*

34-41



**VENÜS SERİSİ**  
*VENUS SERIES*

42-43



**MARS SERİSİ**  
*MARS SERIES*

44-49



**İNCİ SERİSİ**  
*INCI SERIES*

50-51



**POLO SERİSİ**  
*POLO SERIES*

52-55



**DUCK SERİSİ**  
*DUCK SERIES*

56-61



**CARISMA SERİSİ**  
*CARISMA SERIES*

62-63



**DÜNYA SERİSİ**  
*WORLD SERIES*

64-65



**SMARK SERİSİ**  
*SMARK SERIES*

66-67



**SARAY SERİSİ**  
*SARAY SERIES*

68-69



**ŞATO SERİSİ**  
*CHATEAU SERIES*

70-73



**FOTOSEL SERİSİ**  
*PHOTOCELL SERIES*

74-79



**ELİT SERİSİ**  
*ELIT SERIES*

4-7



**MOCHA SERİSİ**  
*MOCHA SERIES*

8-11



**ROKA SERİSİ**  
*ROKA SERIES*

12-29



**SERENA SERİSİ**  
*SERENA SERIES*

30-35



**ÇANAK LAVABO BAT.**  
*HIGH BASIN FAUCET*

36-37

	<b>ARMİNE SERİSİ</b> <i>ARMINE SERIES</i>	<b>80-81</b>		<b>SARI NİPELLER VE UZATMALAR</b> <i>NIPPLE AND EXTENSIONS</i>	<b>109</b>
	<b>DELTA SERİSİ</b> <i>DELTA SERIES</i>	<b>82-83</b>		<b>ANKASTRE TAH. SERİSİ</b> <i>BUILT IN VALVE SERIES</i>	<b>111</b>
	<b>M3000 SERİSİ</b> <i>M3000 SERIES</i>	<b>84</b>		<b>ANK. BANYO SERİSİ</b> <i>BUILT IN BATHROOM SERIES</i>	<b>113-115</b>
	<b>M5000 SERİSİ</b> <i>M5000 SERIES</i>	<b>85</b>		<b>ANKASTRE DUŞ SETLERİ</b> <i>BUILT SHOWER SET</i>	<b>116-117</b>
	<b>L5000 SERİSİ</b> <i>L5000 SERIES</i>	<b>86</b>		<b>DUŞ PANELLERİ</b> <i>SHOWER SET</i>	<b>118-119</b>
	<b>L7000 SERİSİ</b> <i>L7000 SERIES</i>	<b>87</b>		<b>RENKLİ ROBOT DUŞ SETLERİ</b> <i>COLOR ROBOT SHOWER SET</i>	<b>121-124</b>
	<b>WOYA MUSLUK SERİSİ</b> <i>WOYA SERIES</i>	<b>88</b>		<b>KROMLU ROBOT DUŞ SETLERİ</b> <i>CHROME ROBOT SHOWER SET</i>	<b>125</b>
	<b>AKFA MUSLUK SERİSİ</b> <i>AKFA SERIES</i>	<b>89</b>		<b>LUX SÜRGÜLÜ DUŞ SETLERİ</b> <i>LUX SLIDING SYSTEM SHOWER SET</i>	<b>126-127</b>
	<b>TEKLİ MİX BATARYALAR</b> <i>SINGLE MIX FAUCET</i>	<b>90-91</b>		<b>SÜRGÜLÜ DUŞ SETLERİ</b> <i>SLIDING SYSTEM SHOWER SET</i>	<b>128-129</b>
	<b>MEDİKAL SERİSİ</b> <i>MEDICAL SERIES</i>	<b>92-93</b>		<b>LUX MAFSALLI DUŞ SETLERİ</b> <i>LUX WALL BRACKED SHOWER SET</i>	<b>130-131</b>
	<b>ANTİK OSMANLI SERİSİ</b> <i>ANTIQU OTTOMAN SERIES</i>	<b>94-95</b>		<b>MAFSALLI DUŞ SETLERİ</b> <i>WALL BRACKED SHOWER SET</i>	<b>132-133</b>
	<b>LARA SERİSİ</b> <i>LARA SERIES</i>	<b>96-105</b>		<b>EL DUŞLARI</b> <i>SHOWER HEAD</i>	<b>134</b>
	<b>RENKLİ TAHARET MUSL.</b> <i>COLORLED BIDET TAP</i>	<b>106-107</b>		<b>LUX EL DUŞLARI</b> <i>LUX SHOWER HEAD</i>	<b>135</b>
				<b>SHATTAF TAKIMLARI VE SİRALLER</b> <i>SHATTAF SHOWER SET &amp; SİRAL HOSE</i>	<b>136</b>
				<b>PASLANMAZ ÇELİK ÖRGÜLÜ BAĞLANTILAR</b> <i>STAINLESS STEEL BRAIDED CONNECTIONS</i>	<b>137</b>
				<b>YEDEK PARÇALAR</b> <i>SPARE PARTS</i>	<b>138</b>

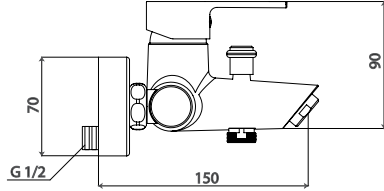

### Mix Banyo Bataryası

- ÜRÜNÜMÜZ MS58/MS63 ORANINDA ALÇAK BASINÇ PİRİNÇ KÜLÇEDEN ÜRETİLMİŞTİR.
- YÜZEY KAPLAMASI 0,12 İLE 0,16 MİKRON KROM KAPLAMADIR.
- ÇIKIŞ UCU UZUNLUĞU 150 mm'DİR.
- 40 BAR BASINCA DAYANIKLI SERAMİK KARTUŞ KULLANILMAKTADIR.
- PERLATÖRÜN SU AKIŞ DEBİSİ DAKİKADA 19 İLE 23 lt ARASINDADIR.
- YÖNLENDİRİCİ TAKIMI MS58 PİRİNÇTEN ÜRETİLMİŞTİR.
- TESİSAT BAĞLANTILARI G ½' DİR.
- EL DUŞU BAĞLANTISI G ½' DİR.

### Mix Bathroom Faucet

- OUR PRODUCT IS MADE OF MS58/MS63 BRASS LOW PRESSURE INGOTS
- SURFACE COATING IS 0,16mm CHROME COATING
- OUTPUT LENGTH 150mm
- 40 BAR PRESSURE RESISTANT CERAMIC CARTRIDGE USED
- WATER FLOW IS BETWEEN 19 AND 23 PER MINUTE
- THE ROYTER TOOLS WAS MADE BRASS'S
- INSTALLATION CONNECTIONS ARE G ½
- HAND SHOWER CONNECTIONS ARE G ½

12 | 2.560,00₺  
Code: 45 2010 2150

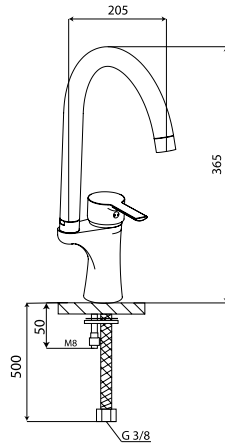

### Mix Kuğu Mutfak Bataryası

- ÜRÜNÜMÜZ MS58 PİRİNÇ MALZEMEDEN ÜRETİLMİŞTİR.
- YÜZEY KAPLAMASI 0,12 İLE 0,16 MİKRON KROM KAPLAMADIR.
- ÇIKIŞ UCU UZUNLUĞU 185 mm'DİR.
- ÇIKIŞ UCU YÜKSEKLİĞİ 345 mm'DİR.
- SU AKIŞ BORUSU ÇAPI 22mm, SU AKIŞ BORUSU MS63 PİRİNÇTİR.
- 360 DERECE DÖNER BORULUDUR.
- 40 BAR BASINCA DAYANIKLI SERAMİK KARTUŞ KULLANILMAKTADIR.
- PERLATÖRÜN SU AKIŞ DEBİSİ DAKİKADA 12 İLE 18 lt ARASINDADIR.
- 3/8 M-10 40 BAR BASINCA DAYANIKLI ÇELİK ÖRGÜLÜ FLEX KULLANILMIŞTIR.

### Mix Kitchen Faucet

- OUR PRODUCT IS MADE OF MS58 BRASS
- SURFACE COATING IS 0,16mm CHROME COATING
- OUTPUT LENGTH 185mm
- OUTPUT END PIPE HEIGHT IS 345mm
- THE DIAMETER FO THE PIPE IS 22, THE WATER FLOW PIPE MS63 IS BRASS
- 360 ROTARY PIPE
- 40 BAR PRESSURE RESISTANT CERAMIC CARTRIDGE USED
- WATER FLOW IS BETWEEN 13 AND 18 PER MINUTE
- G 3/8 M-10 40 BAR PRESSURE RESISTANT STEEL BRAIDED FLEX USED

12 | 1.786,00₺  
Code: 45 2010 2151

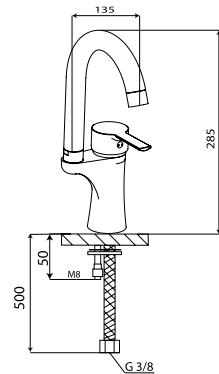

### Mix Kuğu Lavabo Bataryası

- ÜRÜNÜMÜZ MS58 PİRİNÇ MALZEMEDEN ÜRETİLMİŞTİR.
- YÜZEY KAPLAMASI 0,16 MİKRON KROM KAPLAMADIR.
- ÇIKIŞ UCU UZUNLUĞU 140 mm'DİR.
- ÇIKIŞ UCU YÜKSEKLİĞİ 270 mm'DİR.
- SU AKIŞ BORUSU ÇAPI 22mm, SU AKIŞ BORUSU MS63 PİRİNÇ.
- 360 DERECE DÖNER BORULUDUR.
- 40 BAR BASINCA DAYANIKLI SERAMİK KARTUŞ KULLANILMAKTADIR.
- PERLATÖRÜN SU AKIŞ DEBİSİ DAKİKADA 12 İLE 18 lt ARASINDADIR.
- 3/8 M-10 40 BAR BASINCA DAYANIKLI ÇELİK ÖRGÜLÜ FLEX KULLANILMIŞTIR.

### Mix Basin Faucet

- OUR PRODUCT IS MADE OF MS58 BRASS
- SURFACE COATING IS 0,16mm CHROME COATING
- OUTPUT LENGTH 140mm
- OUTPUT END PIPE HEIGHT IS 270mm
- THE DIAMETER FO THE PIPE IS 22, THE WATER FLOW PIPE MS63 IS BRASS
- 360 ROTARY PIPE
- 40 BAR PRESSURE RESISTANT CERAMIC CARTRIDGE USED
- WATER FLOW IS BETWEEN 13 AND 18 PER MINUTE
- G 3/8 M-10 40 BAR PRESSURE RESISTANT STEEL BRAIDED FLEX USED

12 | 1.786,00₺  
Code: 45 2010 2152

## Mix Kuğu Oynar Başlıklı Mutfak Bataryası

- ÜRÜNÜMÜZ MS58 PİRİNÇ MALZEMEDEN ÜRETİLMİŞTİR.
- YÜZEY KAPLAMASI 0,12 İLE 0,16 MİKRON KROM KAPLAMADIR.
- ÇIKIŞ UCU UZUNLUĞU 185 mm'DİR.
- ÇIKIŞ UCU YÜKSEKLİĞİ 345 mm'DİR.
- SU AKIŞ BORUSU ÇAPI 22mm, SU AKIŞ BORUSU MS63 PİRİNÇTİR.
- 360 DERECE DÖNER BORULUDUR.
- 40 BAR BASINCA DAYANIKLI SERAMİK KARTUŞ KULLANILMAKTADIR.
- PERLATÖRÜN SU AKIŞ DEBİSİ DAKİKADA 12 İLE 18 lt ARASINDADIR.
- 3/8 M-10 40 BAR BASINCA DAYANIKLI ÇELİK ÖRGÜLÜ FLEX KULLANILMIŞTIR.

## Mix Kitchen Faucet

- OUR PRODUCT IS MADE OF MS58 BRASS
- SURFACE COATING IS 0,16mm CHROME COATING
- OUTPUT LENGTH 185mm
- OUTPUT END PIPE HEIGHT IS 345mm
- THE DIAMETER FO THE PIPE IS 22, THE WATER FLOW PIPE MS63 IS BRASS
- 360 ROTARY PIPE
- 40 BAR PRESSURE RESISTANT CERAMIC CARTRIDGE USED
- WATER FLOW IS BETWEEN 13 AND 18 PER MINUTE
- G 3/8 M-10 40 BAR PRESSURE RESISTANT STEEL BRAIDED FLEX USED

12 | 1.965,00 ₺  
Code: 45 2010 2160

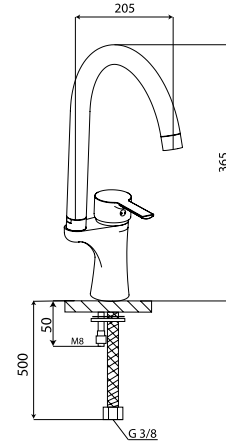

## Mix Kuğu Oynar Başlıklı Lavabo Bataryası

- ÜRÜNÜMÜZ MS58 PİRİNÇ MALZEMEDEN ÜRETİLMİŞTİR.
- YÜZEY KAPLAMASI 0,16 MİKRON KROM KAPLAMADIR.
- ÇIKIŞ UCU UZUNLUĞU 140 mm'DİR.
- ÇIKIŞ UCU YÜKSEKLİĞİ 270 mm'DİR.
- SU AKIŞ BORUSU ÇAPI 22mm, SU AKIŞ BORUSU MS63 PİRİNÇ.
- 360 DERECE DÖNER BORULUDUR.
- 40 BAR BASINCA DAYANIKLI SERAMİK KARTUŞ KULLANILMAKTADIR.
- PERLATÖRÜN SU AKIŞ DEBİSİ DAKİKADA 12 İLE 18 lt ARASINDADIR.
- 3/8 M-10 40 BAR BASINCA DAYANIKLI ÇELİK ÖRGÜLÜ FLEX KULLANILMIŞTIR.

## Mix Basin Faucet

- OUR PRODUCT IS MADE OF MS58 BRASS
- SURFACE COATING IS 0,16mm CHROME COATING
- OUTPUT LENGTH 140mm
- OUTPUT END PIPE HEIGHT IS 270mm
- THE DIAMETER FO THE PIPE IS 22, THE WATER FLOW PIPE MS63 IS BRASS
- 360 ROTARY PIPE
- 40 BAR PRESSURE RESISTANT CERAMIC CARTRIDGE USED
- WATER FLOW IS BETWEEN 13 AND 18 PER MINUTE
- G 3/8 M-10 40 BAR PRESSURE RESISTANT STEEL BRAIDED FLEX USED

12 | 1.965,00 ₺  
Code: 45 2010 2161

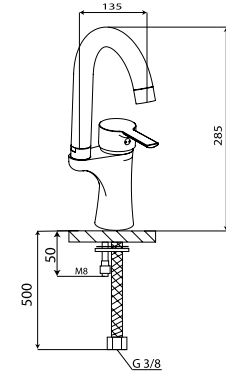

## Mix Lavabo Bataryası

- ÜRÜNÜMÜZ MS58/MS63 ORANINDA ALÇAK BASINÇ PİRİNÇ KÜLÇEDEN ÜRETİLMİŞTİR.
- YÜZEY KAPLAMASI 0,12 İLE 0,16 MİKRON KROM KAPLAMADIR.
- ÇIKIŞ UCU UZUNLUĞU 115 mm'DİR.
- ÜRÜN YÜKSEKLİĞİ 120 mm'DİR.
- 40 BAR BASINCA DAYANIKLI SERAMİK KARTUŞ KULLANILMAKTADIR.
- PERLATÖRÜN SU AKIŞ DEBİSİ DAKİKADA 19 İLE 23 lt ARASINDADIR.
- 3/8 M-10 40 BAR BASINCA DAYANIKLI ÇELİK ÖRGÜLÜ FLEX KULLANILMIŞTIR.

## Mix Basin Faucet

- OUR PRODUCT IS MADE OF MS58/MS63 BRASS LOW PRESSURE INGOTS
- SURFACE COATING IS 0,16mm CHROME COATING
- OUTPUT LENGTH 115 mm
- PRODUCT HEIGHT 120 mm
- 40 BAR PRESSURE RESISTANT CERAMIC CARTRIDGE USED
- WATER FLOW IS BETWEEN 19 AND 23 PER MINUTE
- G 3/8 M-10 40 BAR PRESSURE RESISTANT STEEL BRAIDED FLEX USED

12 | 2.590,00 ₺  
Code: 45 2010 2153

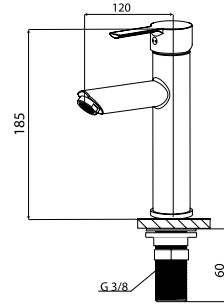

## Mix Çanak Lavabo Bataryası

- ÜRÜNÜMÜZ MS58/MS63 ORANINDA ALÇAK BASINÇ PİRİNÇ KÜLÇEDEN ÜRETİLMİŞTİR.
- YÜZEY KAPLAMASI 0,12 İLE 0,16 MİKRON KROM KAPLAMADIR.
- YÜZEY KAPLAMASI ÖZEL ALTIN BOYADIR.
- YÜZEY KAPLAMASI PULVER 916 BOYADIR.
- ÇIKIŞ UCU UZUNLUĞU 118 mm'DİR.
- ÜRÜN YÜKSEKLİĞİ 165 mm'DİR.
- 40 BAR BASINCA DAYANIKLI SERAMİK KARTUŞ KULLANILMAKTADIR.
- PERLATÖRÜN SU AKIŞ DEBİSİ DAKİKADA 19 İLE 23 lt ARASINDADIR.
- 3/8 M-10 40 BAR BASINCA DAYANIKLI ÇELİK ÖRGÜLÜ FLEX KULLANILMIŞTIR.

## Mix Basin Faucet

- OUR PRODUCT IS MADE OF MS58/MS63 BRASS LOW PRESSURE INGOTS
- SURFACE COATING IS 0,16mm CHROME COATING
- SURFACE COATING IS SPECIAL GOLD PAINT.
- SURFACE COATING IS PAINTED 916.
- OUTPUT LENGTH 118 mm
- PRODUCT HEIGHT 165 mm
- 40 BAR PRESSURE RESISTANT CERAMIC CARTRIDGE USED
- WATER FLOW IS BETWEEN 19 AND 23 PER MINUTE
- G 3/8 M-10 40 BAR PRESSURE RESISTANT STEEL BRAIDED FLEX USED

9 | 3.750,00 ₺  
Code: 45 2010 2154

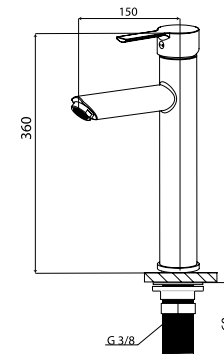

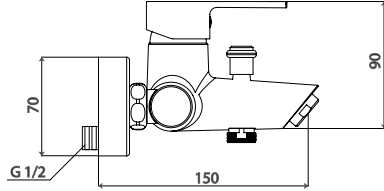

### Mix Banyo Bataryası

- ÜRÜNÜMÜZ MS58/MS63 ORANINDA ALÇAK BASINÇ PİRİNÇ KÜLÇEDEN ÜRETİLMİŞTİR.
- YÜZEY KAPLAMASI 0,12 İLE 0,16 MİKRON KROM KAPLAMADIR.
- ÇIKIŞ UCU UZUNLUĞU 150 mm'DİR.
- 40 BAR BASINCA DAYANIKLI SERAMİK KARTUŞ KULLANILMAKTADIR.
- PERLATÖRÜN SU AKIŞ DEBİSİ DAKİKADA 19 İLE 23 lt ARASINDADIR.
- YÖNLENDİRİCİ TAKIMI MS58 PİRİNÇTEN ÜRETİLMİŞTİR.
- TESİSAT BAĞLANTILARI G ½' DİR.
- EL DUŞU BAĞLANTISI G ½' DİR.

### Mix Bathroom Faucet

- OUR PRODUCT IS MADE OF MS58/MS63 BRASS LOW PRESSURE INGOTS
- SURFACE COATING IS 0,16mm CHROME COATING
- OUTPUT LENGTH 150mm
- 40 BAR PRESSURE RESISTANT CERAMIC CARTRIDGE USED
- WATER FLOW IS BETWEEN 19 AND 23 PER MINUTE
- THE ROTYER TOOLS WAS MADE BRASS'S
- INSTALLATION CONNECTIONS ARE G ½
- HAND SHOWER CONNECTIONS ARE G ½

12 | 3.012,00 ₺

Code: 45 2010 2162

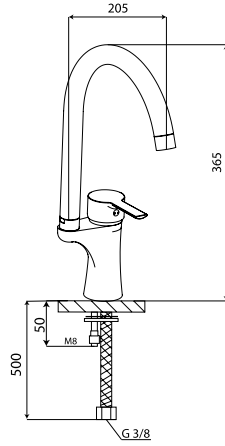

### Mix Kuğu Mutfak Bataryası

- ÜRÜNÜMÜZ MS58 PİRİNÇ MALZEMEDEN ÜRETİLMİŞTİR.
- YÜZEY KAPLAMASI 0,12 İLE 0,16 MİKRON KROM KAPLAMADIR.
- ÇIKIŞ UCU UZUNLUĞU 185 mm'DİR.
- ÇIKIŞ UCU YÜKSEKLİĞİ 345 mm'DİR.
- SU AKIŞ BORUSU ÇAPI 22mm, SU AKIŞ BORUSU MS63 PİRİNÇTİR.
- 360 DERECE DÖNER BORULUDUR.
- 40 BAR BASINCA DAYANIKLI SERAMİK KARTUŞ KULLANILMAKTADIR.
- PERLATÖRÜN SU AKIŞ DEBİSİ DAKİKADA 12 İLE 18 lt ARASINDADIR.
- 3/8 M-10 40 BAR BASINCA DAYANIKLI ÇELİK ÖRGÜLÜ FLEX KULLANILMIŞTIR.

### Mix Kitchen Faucet

- OUR PRODUCT IS MADE OF MS58 BRASS
- SURFACE COATING IS 0,16mm CHROME COATING
- OUTPUT LENGTH 185mm
- OUTPUT END PIPE HEIGHT IS 345mm
- THE DIAMETER FO THE PIPE IS 22, THE WATER FLOW PIPE MS63 IS BRASS
- 360 ROTARY PIPE
- 40 BAR PRESSURE RESISTANT CERAMIC CARTRIDGE USED
- WATER FLOW IS BETWEEN 13 AND 18 PER MINUTE
- G 3/8 M-10 40 BAR PRESSURE RESISTANT STEEL BRAIDED FLEX USED

12 | 2.165,00 ₺

Code: 45 2010 2163

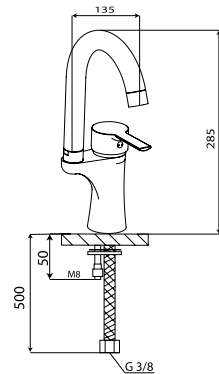

### Mix Kuğu Lavabo Bataryası

- ÜRÜNÜMÜZ MS58 PİRİNÇ MALZEMEDEN ÜRETİLMİŞTİR.
- YÜZEY KAPLAMASI 0,16 MİKRON KROM KAPLAMADIR.
- ÇIKIŞ UCU UZUNLUĞU 140 mm'DİR.
- ÇIKIŞ UCU YÜKSEKLİĞİ 270 mm'DİR.
- SU AKIŞ BORUSU ÇAPI 22mm, SU AKIŞ BORUSU MS63 PİRİNÇ.
- 360 DERECE DÖNER BORULUDUR.
- 40 BAR BASINCA DAYANIKLI SERAMİK KARTUŞ KULLANILMAKTADIR.
- PERLATÖRÜN SU AKIŞ DEBİSİ DAKİKADA 12 İLE 18 lt ARASINDADIR.
- 3/8 M-10 40 BAR BASINCA DAYANIKLI ÇELİK ÖRGÜLÜ FLEX KULLANILMIŞTIR.

### Mix Basin Faucet

- OUR PRODUCT IS MADE OF MS58 BRASS
- SURFACE COATING IS 0,16mm CHROME COATING
- OUTPUT LENGTH 140mm
- OUTPUT END PIPE HEIGHT IS 270mm
- THE DIAMETER FO THE PIPE IS 22, THE WATER FLOW PIPE MS63 IS BRASS
- 360 ROTARY PIPE
- 40 BAR PRESSURE RESISTANT CERAMIC CARTRIDGE USED
- WATER FLOW IS BETWEEN 13 AND 18 PER MINUTE
- G 3/8 M-10 40 BAR PRESSURE RESISTANT STEEL BRAIDED FLEX USED

12 | 2.165,00 ₺

Code: 45 2010 2164



### Mix Lavabo Bataryası

- ÜRÜNÜMÜZ MS58/MS63 ORANINDA ALÇAK BASINÇ PİRİNÇ KÜLÇEDEN ÜRETİLMİŞTİR.
- YÜZEY KAPLAMASI 0,12 İLE 0,16 MİKRON KROM KAPLAMADIR.
- ÇIKIŞ UCU UZUNLUĞU 115 mm'DİR.
- ÜRÜN YÜKSEKLİĞİ 120 mm'DİR.
- 40 BAR BASINCA DAYANIKLI SERAMİK KARTUŞ KULLANILMAKTADIR.
- PERLATÖRÜN SU AKIŞ DEBİSİ DAKİKADA 19 İLE 23 lt ARASINDADIR.
- 3/8 M-10 40 BAR BASINCA DAYANIKLI ÇELİK ÖRGÜLÜ FLEX KULLANILMIŞTIR.

### Mix Basın Faucet

- OUR PRODUCT IS MADE OF MS58/MS63 BRASS LOW PRESSURE INGOTS
- SURFACE COATING IS 0,16mm CHROME COATING
- OUTPUT LENGTH 115 mm
- PRODUCT HEIGHT 120 mm
- 40 BAR PRESSURE RESISTANT CERAMIC CARTRIDGE USED
- WATER FLOW IS BETWEEN 19 AND 23 PER MINUTE
- G 3/8 M-10 40 BAR PRESSURE RESISTANT STEEL BRAIDED FLEX USED

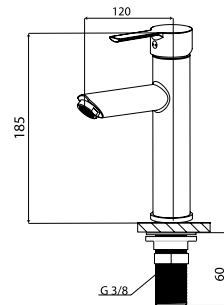

12 2.990,00 ₺

Code: 45 2010 2167

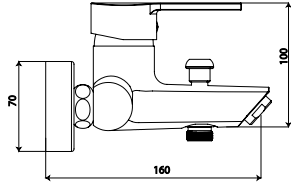

### Mix Banyo Bataryası

- ÜRÜNÜMÜZ MS58/MS63 ORANINDA ALÇAK BASINÇ PİRİNÇ KÜLÇEDEN ÜRETİLMİŞTİR.
- YÜZEY KAPLAMASI 0,12 İLE 0,16 MİKRON KROM KAPLAMADIR.
- ÇIKIŞ UCU UZUNLUĞU 150 mm'DİR.
- 40 BAR BASINCA DAYANIKLI SERAMİK KARTUŞ KULLANILMAKTADIR.
- PERLATÖRÜN SU AKIŞ DEBİSİ DAKİKADA 19 İLE 23 lt ARASINDADIR.
- YÖNLENDİRİCİ TAKIMI MS58 PİRİNÇTEN ÜRETİLMİŞTİR.
- TESİSAT BAĞLANTILARI G ½' DİR.
- EL DUŞU BAĞLANTISI G ½' DİR.

### Mix Bathroom Faucet

- OUR PRODUCT IS MADE OF MS58/MS63 BRASS LOW PRESSURE INGOTS
- SURFACE COATING IS 0,16mm CHROME COATING
- OUTPUT LENGTH 150mm
- 40 BAR PRESSURE RESISTANT CERAMIC CARTRIDGE USED
- WATER FLOW IS BETWEEN 19 AND 23 PER MINUTE
- THE ROYTER TOOLS WAS MADE BRASS'S
- INSTALLATION CONNECTIONS ARE G ½
- HAND SHOWER CONNECTIONS ARE G ½

12 | 3.050,00 ₺

Code: 82 2018 0040

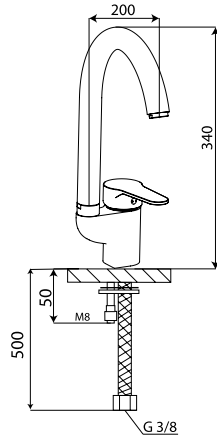

### Mix Kuğu Mutfak Bataryası

- ÜRÜNÜMÜZ MS58 PİRİNÇ MALZEMEDEN ÜRETİLMİŞTİR.
- YÜZEY KAPLAMASI 0,12 İLE 0,16 MİKRON KROM KAPLAMADIR.
- ÇIKIŞ UCU UZUNLUĞU 185 mm'DİR.
- ÇIKIŞ UCU YÜKSEKLİĞİ 345 mm'DİR.
- SU AKIŞ BORUSU ÇAPI 22mm, SU AKIŞ BORUSU MS63 PİRİNÇTİR.
- 360 DERECE DÖNER BORULUDUR.
- 40 BAR BASINCA DAYANIKLI SERAMİK KARTUŞ KULLANILMAKTADIR.
- PERLATÖRÜN SU AKIŞ DEBİSİ DAKİKADA 12 İLE 18 lt ARASINDADIR.
- 3/8 M-10 40 BAR BASINCA DAYANIKLI ÇELİK ÖRGÜLÜ FLEX KULLANILMIŞTIR.

### Mix Kitchen Faucet

- OUR PRODUCT IS MADE OF MS58 BRASS
- SURFACE COATING IS 0,16mm CHROME COATING
- OUTPUT LENGTH 185mm
- OUTPUT END PIPE HEIGHT IS 345mm
- THE DIAMETER FO THE PIPE IS 22, THE WATER FLOW PIPE MS63 IS BRASS
- 360 ROTARY PIPE
- 40 BAR PRESSURE RESISTANT CERAMIC CARTRIDGE USED
- WATER FLOW IS BETWEEN 13 AND 18 PER MINUTE
- G 3/8 M-10 40 BAR PRESSURE RESISTANT STEEL BRAIDED FLEX USED

12 | 1.969,00 ₺

Code: 82 2018 0043

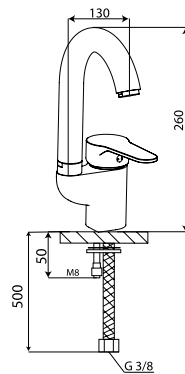

### Mix Kuğu Lavabo Bataryası

- ÜRÜNÜMÜZ MS58 PİRİNÇ MALZEMEDEN ÜRETİLMİŞTİR.
- YÜZEY KAPLAMASI 0,16 MİKRON KROM KAPLAMADIR.
- ÇIKIŞ UCU UZUNLUĞU 140 mm'DİR.
- ÇIKIŞ UCU YÜKSEKLİĞİ 270 mm'DİR.
- SU AKIŞ BORUSU ÇAPI 22mm, SU AKIŞ BORUSU MS63 PİRİNÇ.
- 360 DERECE DÖNER BORULUDUR.
- 40 BAR BASINCA DAYANIKLI SERAMİK KARTUŞ KULLANILMAKTADIR.
- PERLATÖRÜN SU AKIŞ DEBİSİ DAKİKADA 12 İLE 18 lt ARASINDADIR.
- 3/8 M-10 40 BAR BASINCA DAYANIKLI ÇELİK ÖRGÜLÜ FLEX KULLANILMIŞTIR.

### Mix Basin Faucet

- OUR PRODUCT IS MADE OF MS58 BRASS
- SURFACE COATING IS 0,16mm CHROME COATING
- OUTPUT LENGTH 140mm
- OUTPUT END PIPE HEIGHT IS 270mm
- THE DIAMETER FO THE PIPE IS 22, THE WATER FLOW PIPE MS63 IS BRASS
- 360 ROTARY PIPE
- 40 BAR PRESSURE RESISTANT CERAMIC CARTRIDGE USED
- WATER FLOW IS BETWEEN 13 AND 18 PER MINUTE
- G 3/8 M-10 40 BAR PRESSURE RESISTANT STEEL BRAIDED FLEX USED

12 | 1.969,00 ₺

Code: 82 2018 0044



**Mix Kuğu Oynar Başlıklı Mutfak Bataryası**

- ÜRÜNÜMÜZ MS58 PİRİNÇ MALZEMEDEN ÜRETİLMİŞTİR.
- YÜZEY KAPLAMASI 0,12 İLE 0,16 MİKRON KROM KAPLAMADIR.
- ÇIKIŞ UCU UZUNLUĞU 185 mm'DİR.
- ÇIKIŞ UCU YÜKSEKLİĞİ 345 mm'DİR.
- SU AKIŞ BORUSU ÇAPI 22mm, SU AKIŞ BORUSU MS63 PİRİNÇTİR.
- 360 DERECE DÖNER BORULUDUR.
- 40 BAR BASINCA DAYANIKLI SERAMİK KARTUŞ KULLANILMAKTADIR.
- PERLATÖRÜN SU AKIŞ DEBİSİ DAKİKADA 12 İLE 18 lt ARASINDADIR.
- 3/8 M-10 40 BAR BASINCA DAYANIKLI ÇELİK ÖRGÜLÜ FLEX KULLANILMIŞTIR.

**Mix Kitchen Faucet**

- OUR PRODUCT IS MADE OF MS58 BRASS
- SURFACE COATING IS 0,16mm CHROME COATING
- OUTPUT LENGTH 185mm
- OUTPUT END PIPE HEIGHT IS 345mm
- THE DIAMETER FO THE PIPE IS 22, THE WATER FLOW PIPE MS63 IS BRASS
- 360 ROTARY PIPE
- 40 BAR PRESSURE RESISTANT CERAMIC CARTRIDGE USED
- WATER FLOW IS BETWEEN 13 AND 18 PER MINUTE
- G 3/8 M-10 40 BAR PRESSURE RESISTANT STEEL BRAIDED FLEX USED

 | 2.220,00 ₺

Code: 82 2018 0050

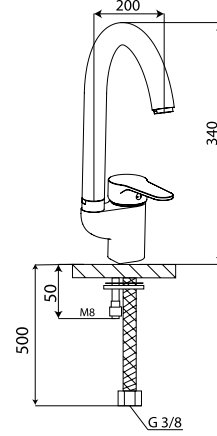
**Mix Kuğu Oynar Başlıklı Lavabo Bataryası**

- ÜRÜNÜMÜZ MS58 PİRİNÇ MALZEMEDEN ÜRETİLMİŞTİR.
- YÜZEY KAPLAMASI 0,16 MİKRON KROM KAPLAMADIR.
- ÇIKIŞ UCU UZUNLUĞU 140 mm'DİR.
- ÇIKIŞ UCU YÜKSEKLİĞİ 270 mm'DİR.
- SU AKIŞ BORUSU ÇAPI 22mm, SU AKIŞ BORUSU MS63 PİRİNÇ.
- 360 DERECE DÖNER BORULUDUR.
- 40 BAR BASINCA DAYANIKLI SERAMİK KARTUŞ KULLANILMAKTADIR.
- PERLATÖRÜN SU AKIŞ DEBİSİ DAKİKADA 12 İLE 18 lt ARASINDADIR.
- 3/8 M-10 40 BAR BASINCA DAYANIKLI ÇELİK ÖRGÜLÜ FLEX KULLANILMIŞTIR.

**Mix Basin Faucet**

- OUR PRODUCT IS MADE OF MS58 BRASS
- SURFACE COATING IS 0,16mm CHROME COATING
- OUTPUT LENGTH 140mm
- OUTPUT END PIPE HEIGHT IS 270mm
- THE DIAMETER FO THE PIPE IS 22, THE WATER FLOW PIPE MS63 IS BRASS
- 360 ROTARY PIPE
- 40 BAR PRESSURE RESISTANT CERAMIC CARTRIDGE USED
- WATER FLOW IS BETWEEN 13 AND 18 PER MINUTE
- G 3/8 M-10 40 BAR PRESSURE RESISTANT STEEL BRAIDED FLEX USED

 | 2.220,00 ₺

Code: 82 2018 0051

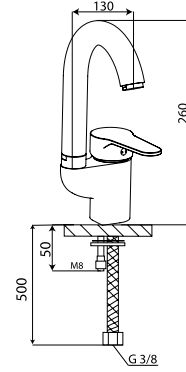
**Mix Sabit Lavabo Bataryası**

- ÜRÜNÜMÜZ MS58/MS63 ORANINDA ALÇAK BASINÇ PİRİNÇ KÜLÇEDEN ÜRETİLMİŞTİR.
- YÜZEY KAPLAMASI 0,12 İLE 0,16 MİKRON KROM KAPLAMADIR.
- ÇIKIŞ UCU UZUNLUĞU 115 mm'DİR.
- ÜRÜN YÜKSEKLİĞİ 120 mm'DİR.
- 40 BAR BASINCA DAYANIKLI SERAMİK KARTUŞ KULLANILMAKTADIR.
- PERLATÖRÜN SU AKIŞ DEBİSİ DAKİKADA 19 İLE 23 lt ARASINDADIR.
- 3/8 M-10 40 BAR BASINCA DAYANIKLI ÇELİK ÖRGÜLÜ FLEX KULLANILMIŞTIR.

**Mix Basin Faucet**

- OUR PRODUCT IS MADE OF MS58/MS63 BRASS LOW PRESSURE INGOTS
- SURFACE COATING IS 0,16mm CHROME COATING
- OUTPUT LENGTH 115 mm
- PRODUCT HEIGHT 120 mm
- 40 BAR PRESSURE RESISTANT CERAMIC CARTRIDGE USED
- WATER FLOW IS BETWEEN 19 AND 23 PER MINUTE
- G 3/8 M-10 40 BAR PRESSURE RESISTANT STEEL BRAIDED FLEX USED

 | 2.490,00 ₺

Code: 82 2018 0042

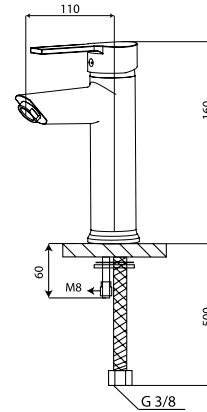

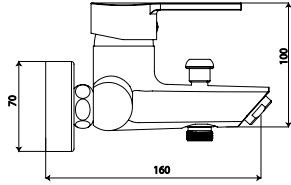

### Mix Banyo Bataryası

- ÜRÜNÜMÜZ MS58/MS63 ORANINDA ALÇAK BASINÇ PİRİNÇ KÜLÇEDEN ÜRETİLMİŞTİR.
- YÜZEY KAPLAMASI 0,12 İLE 0,16 MİKRON KROM KAPLAMADIR.
- ÇIKIŞ UCU UZUNLUĞU 150 mm'DİR.
- 40 BAR BASINCA DAYANIKLI SERAMİK KARTUŞ KULLANILMAKTADIR.
- PERLATÖRÜN SU AKIŞ DEBİSİ DAKİKADA 19 İLE 23 lt ARASINDADIR.
- YÖNLENDİRİCİ TAKIMI MS58 PİRİNÇTEN ÜRETİLMİŞTİR.
- TESİSAT BAĞLANTILARI G ½' DİR.
- EL DUŞU BAĞLANTISI G ½' DİR.

### Mix Bathroom Faucet

- OUR PRODUCT IS MADE OF MS58/MS63 BRASS LOW PRESSURE INGOTS
- SURFACE COATING IS 0,16mm CHROME COATING
- OUTPUT LENGTH 150mm
- 40 BAR PRESSURE RESISTANT CERAMIC CARTRIDGE USED
- WATER FLOW IS BETWEEN 19 AND 23 PER MINUTE
- THE ROYTER TOOLS WAS MADE BRASS'S
- INSTALLATION CONNECTIONS ARE G ½
- HAND SHOWER CONNECTIONS ARE G ½

12 | 3.641,00 ₺

Code: 82 2018 0045

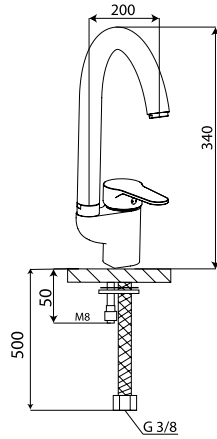

### Mix Kuğu Mutfak Bataryası

- ÜRÜNÜMÜZ MS58 PİRİNÇ MALZEMEDEN ÜRETİLMİŞTİR.
- YÜZEY KAPLAMASI 0,12 İLE 0,16 MİKRON KROM KAPLAMADIR.
- ÇIKIŞ UCU UZUNLUĞU 185 mm'DİR.
- ÇIKIŞ UCU YÜKSEKLİĞİ 345 mm'DİR.
- SU AKIŞ BORUSU ÇAPI 22mm, SU AKIŞ BORUSU MS63 PİRİNÇTİR.
- 360 DERECE DÖNER BORULUDUR.
- 40 BAR BASINCA DAYANIKLI SERAMİK KARTUŞ KULLANILMAKTADIR.
- PERLATÖRÜN SU AKIŞ DEBİSİ DAKİKADA 12 İLE 18 lt ARASINDADIR.
- 3/8 M-10 40 BAR BASINCA DAYANIKLI ÇELİK ÖRGÜLÜ FLEX KULLANILMIŞTIR.

### Mix Kitchen Faucet

- OUR PRODUCT IS MADE OF MS58 BRASS
- SURFACE COATING IS 0,16mm CHROME COATING
- OUTPUT LENGTH 185mm
- OUTPUT END PIPE HEIGHT IS 345mm
- THE DIAMETER FO THE PIPE IS 22, THE WATER FLOW PIPE MS63 IS BRASS
- 360 ROTARY PIPE
- 40 BAR PRESSURE RESISTANT CERAMIC CARTRIDGE USED
- WATER FLOW IS BETWEEN 13 AND 18 PER MINUTE
- G 3/8 M-10 40 BAR PRESSURE RESISTANT STEEL BRAIDED FLEX USED

12 | 2.363,00 ₺

Code: 82 2018 0049

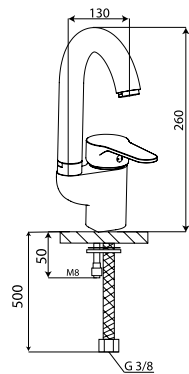

### Mix Kuğu Lavabo Bataryası

- ÜRÜNÜMÜZ MS58 PİRİNÇ MALZEMEDEN ÜRETİLMİŞTİR.
- YÜZEY KAPLAMASI 0,16 MİKRON KROM KAPLAMADIR.
- ÇIKIŞ UCU UZUNLUĞU 140 mm'DİR.
- ÇIKIŞ UCU YÜKSEKLİĞİ 270 mm'DİR.
- SU AKIŞ BORUSU ÇAPI 22mm, SU AKIŞ BORUSU MS63 PİRİNÇ.
- 360 DERECE DÖNER BORULUDUR.
- 40 BAR BASINCA DAYANIKLI SERAMİK KARTUŞ KULLANILMAKTADIR.
- PERLATÖRÜN SU AKIŞ DEBİSİ DAKİKADA 12 İLE 18 lt ARASINDADIR.
- 3/8 M-10 40 BAR BASINCA DAYANIKLI ÇELİK ÖRGÜLÜ FLEX KULLANILMIŞTIR.

### Mix Basin Faucet

- OUR PRODUCT IS MADE OF MS58 BRASS
- SURFACE COATING IS 0,16mm CHROME COATING
- OUTPUT LENGTH 140mm
- OUTPUT END PIPE HEIGHT IS 270mm
- THE DIAMETER FO THE PIPE IS 22, THE WATER FLOW PIPE MS63 IS BRASS
- 360 ROTARY PIPE
- 40 BAR PRESSURE RESISTANT CERAMIC CARTRIDGE USED
- WATER FLOW IS BETWEEN 13 AND 18 PER MINUTE
- G 3/8 M-10 40 BAR PRESSURE RESISTANT STEEL BRAIDED FLEX USED

12 | 2.363,00 ₺

Code: 82 2018 0048



### Mix Sabit Lavabo Bataryası

- ÜRÜNÜMÜZ MS58/MS63 ORANINDA ALÇAK BASINÇ PİRİNÇ KÜLÇEDEN ÜRETİLMİŞTİR.
- YÜZEY KAPLAMASI 0,12 İLE 0,16 MİKRON KROM KAPLAMADIR.
- ÇIKIŞ UCU UZUNLUĞU 115 mm'DİR.
- ÜRÜN YÜKSEKLİĞİ 120 mm'DİR.
- 40 BAR BASINCA DAYANIKLI SERAMİK KARTUŞ KULLANILMAKTADIR.
- PERLATÖRÜN SU AKIŞ DEBİSİ DAKİKADA 19 İLE 23 lt ARASINDADIR.
- 3/8 M-10 40 BAR BASINCA DAYANIKLI ÇELİK ÖRGÜLÜ FLEX KULLANILMIŞTIR.

### Mix Basın Faucet

- OUR PRODUCT IS MADE OF MS58/MS63 BRASS LOW PRESSURE INGOTS
- SURFACE COATING IS 0,16mm CHROME COATING
- OUTPUT LENGTH 115 mm
- PRODUCT HEIGHT 120 mm
- 40 BAR PRESSURE RESISTANT CERAMIC CARTRIDGE USED
- WATER FLOW IS BETWEEN 19 AND 23 PER MINUTE
- G 3/8 M-10 40 BAR PRESSURE RESISTANT STEEL BRAIDED FLEX USED

12 | 2.790,00 ₺

Code: 82 2018 0047

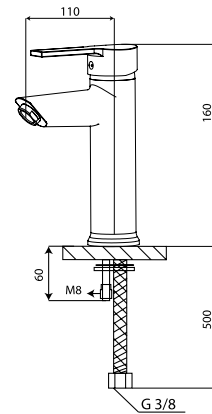

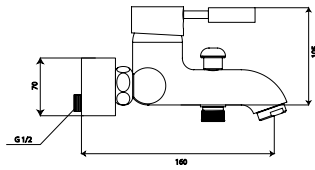

### Mix Banyo Bataryası

- ÜRÜNÜMÜZ MS58/MS63 ORANINDA ALÇAK BASINÇ PİRİNÇ KÜLÇEDEN ÜRETİLMİŞTİR.
- YÜZEY KAPLAMASI 0,12 İLE 0,16 MİKRON KROM KAPLAMADIR.
- ÇIKIŞ UCU UZUNLUĞU 160 mm'DİR.
- 40 BAR BASINCA DAYANIKLI SERAMİK KARTUŞ KULLANILMAKTADIR.
- PERLATÖRÜN SU AKIŞ DEBİSİ DAKİKADA 19 İLE 23 lt ARASINDADIR.
- YÖNLENDİRİCİ TAKIMI MS58 PİRİNÇTEN ÜRETİLMİŞTİR.
- TESİSAT BAĞLANTILARI G ½' DİR.
- EL DUŞU BAĞLANTISI G ½' DİR.

### Mix Bathroom Faucet

- OUR PRODUCT IS MADE OF MS58/MS63 BRASS LOW PRESSURE INGOTS
- SURFACE COATING IS 0,16mm CHROME COATING
- OUTPUT LENGTH 160mm
- 40 BAR PRESSURE RESISTANT CERAMIC CARTRIDGE USED
- WATER FLOW IS BETWEEN 19 AND 23 PER MINUTE
- THE ROYTER TOOLS WAS MADE BRASS'S
- INSTALLATION CONNECTIONS ARE G ½
- HAND SHOWER CONNECTIONS ARE G ½

12 | 2.900,00 ₺

Code: 43 2010 0801

**Mix Kuğu Mutfak Bataryası**

- ÜRÜNÜMÜZ MS58 PİRİNÇ MALZEMEDEN ÜRETİLMİŞTİR.
- YÜZEY KAPLAMASI 0,12 İLE 0,16 MİKRON KROM KAPLAMADIR.
- ÇIKIŞ UCU UZUNLUĞU 180 mm'DİR.
- ÇIKIŞ UCU YÜKSEKLİĞİ 320 mm'DİR.
- SU AKIŞ BORUSU ÇAPI 22, SU AKIŞ BORUSU MS63 PİRİNÇTİR.
- 360 DERECE DÖNER BORULUDUR.
- 40 BAR BASINCA DAYANIKLI SERAMİK KARTUŞ KULLANILMAKTADIR.
- PERLATÖRÜN SU AKIŞ DEBİSİ DAKİKADA12 İLE 18 lt ARASINDADIR.
- 3/8 M-10 40 BAR BASINCA DAYANIKLI ÇELİK ÖRGÜLÜ FLEX KULLANILMIŞTIR.

**Mix Kitchen Faucet**

- OUR PRODUCT IS MADE OF MS58 BRASS
- SURFACE COATING IS 0,16mm CHROME COATING
- OUTPUT LENGTH 180mm
- OUTPUT END PIPE HEIGHT IS 320mm
- THE DIAMETER FO THE PIPE IS 22, THE WATER FLOW PIPE MS63 IS BRASS
- 360 ROTARY PIPE
- 40 BAR PRESSURE RESISTANT CERAMIC CARTRIDGE USED
- WATER FLOW IS BETWEEN 13 AND 18 PER MINUTE
- G 3/8 M-10 40 BAR PRESSURE RESISTANT STEEL BRAIDED FLEX USED

 | 1.990,00 ₺

Code: 43 2010 0803

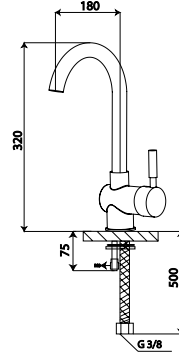
**Mix Kuğu Lavabo Bataryası**

- ÜRÜNÜMÜZ MS58 PİRİNÇ MALZEMEDEN ÜRETİLMİŞTİR.
- YÜZEY KAPLAMASI 0,16 MİKRON KROM KAPLAMADIR.
- ÇIKIŞ UCU UZUNLUĞU 120 mm'DİR.
- ÇIKIŞ UCU YÜKSEKLİĞİ 225 mm'DİR.
- SU AKIŞ BORUSU ÇAPI 22, SU AKIŞ BORUSU MS63 PİRİNÇTİR.
- 360 DERECE DÖNER BORULUDUR.
- 40 BAR BASINCA DAYANIKLI SERAMİK KARTUŞ KULLANILMAKTADIR.
- PERLATÖRÜN SU AKIŞ DEBİSİ DAKİKADA12 İLE 18 lt ARASINDADIR.
- 3/8 M-10 40 BAR BASINCA DAYANIKLI ÇELİK ÖRGÜLÜ FLEX KULLANILMIŞTIR.

**Mix Basin Faucet**

- OUR PRODUCT IS MADE OF MS58 BRASS
- SURFACE COATING IS 0,16mm CHROME COATING
- OUTPUT LENGTH 120mm
- OUTPUT END PIPE HEIGHT IS 225mm
- THE DIAMETER FO THE PIPE IS 18, THE WATER FLOW PIPE MS63 IS BRASS
- 360 ROTARY PIPE
- 40 BAR PRESSURE RESISTANT CERAMIC CARTRIDGE USED
- WATER FLOW IS BETWEEN 13 AND 18 PER MINUTE
- G 3/8 M-10 40 BAR PRESSURE RESISTANT STEEL BRAIDED FLEX USED

 | 1.990,00 ₺

Code: 43 2010 0804

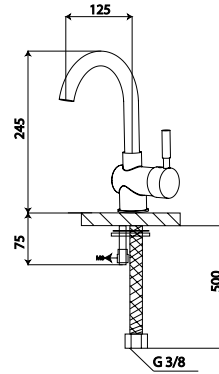
**Mix Lavabo Bataryası**

- ÜRÜNÜMÜZ MS58/MS63 ORANINDA ALÇAK BASINÇ PİRİNÇ KÜLÇEDEN ÜRETİLMİŞTİR.
- YÜZEY KAPLAMASI 0,12 İLE 0,16 MİKRON KROM KAPLAMADIR.
- ÇIKIŞ UCU UZUNLUĞU 120 mm'DİR.
- ÜRÜN YÜKSEKLİĞİ 165 mm'DİR.
- 40 BAR BASINCA DAYANIKLI SERAMİK KARTUŞ KULLANILMAKTADIR.
- PERLATÖRÜN SU AKIŞ DEBİSİ DAKİKADA19 İLE 23 lt ARASINDADIR.
- 3/8 M-10 40 BAR BASINCA DAYANIKLI ÇELİK ÖRGÜLÜ FLEX KULLANILMIŞTIR.

**Mix Basin Faucet**

- OUR PRODUCT IS MADE OF MS58/MS63 BRASS LOW PRESSURE INGOTS
- SURFACE COATING IS 0,16mm CHROME COATING
- OUTPUT LENGTH 120 mm
- PRODUCT HEIGHT 165 mm
- 40 BAR PRESSURE RESISTANT CERAMIC CARTRIDGE USED
- WATER FLOW IS BETWEEN 19 AND 23 PER MINUTE
- G 3/8 M-10 40 BAR PRESSURE RESISTANT STEEL BRAIDED FLEX USED

 | 2.430,00 ₺

Code: 43 2010 0802

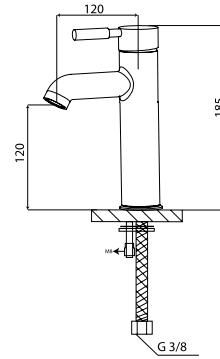
**Mix Yüksek Çanak Lavabo Bataryası**

- ÜRÜNÜMÜZ MS58/MS63 ORANINDA ALÇAK BASINÇ PİRİNÇ KÜLÇEDEN ÜRETİLMİŞTİR.
- YÜZEY KAPLAMASI 0,12 İLE 0,16 MİKRON KROM KAPLAMADIR.
- YÜZEY KAPLAMASI ÖZEL ALTIN BOYADIR.
- YÜZEY KAPLAMASI PULVER 916 BOYADIR.
- ÇIKIŞ UCU UZUNLUĞU 120 mm'DİR.
- ÜRÜN YÜKSEKLİĞİ 360 mm'DİR.
- 40 BAR BASINCA DAYANIKLI SERAMİK KARTUŞ KULLANILMAKTADIR.
- PERLATÖRÜN SU AKIŞ DEBİSİ DAKİKADA19 İLE 23 lt ARASINDADIR.
- 3/8 M-10 40 BAR BASINCA DAYANIKLI ÇELİK ÖRGÜLÜ FLEX KULLANILMIŞTIR.

**Mix High Basin Faucet**

- OUR PRODUCT IS MADE OF MS58/MS63 BRASS LOW PRESSURE INGOTS
- SURFACE COATING IS 0,16mm CHROME COATING
- SURFACE COATING IS SPECIAL GOLD PAINT.
- SURFACE COATING IS PAINTED 916.
- OUTPUT LENGTH 120 mm
- PRODUCT HEIGHT 360 mm
- 40 BAR PRESSURE RESISTANT CERAMIC CARTRIDGE USED
- WATER FLOW IS BETWEEN 19 AND 23 PER MINUTE
- G 3/8 M-10 40 BAR PRESSURE RESISTANT STEEL BRAIDED FLEX USED

 | 3.500,00 ₺

Code: 43 2010 0807

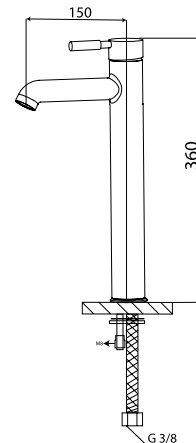



## GOLD

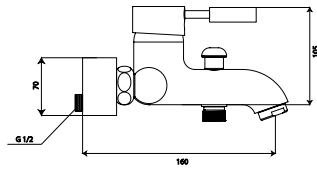

### Mix Banyo Bataryası

- ÜRÜNÜMÜZ MS58/MS63 ORANINDA ALÇAK BASINÇ PİRİNÇ KÜLÇEDEN ÜRETİLMİŞTİR.
- YÜZEY KAPLAMASI 0,12 İLE 0,16 MİKRON KROM KAPLAMADIR.
- ÇIKIŞ UCU UZUNLUĞU 160 mm'DİR.
- 40 BAR BASINCA DAYANIKLI SERAMİK KARTUŞ KULLANILMAKTADIR.
- PERLATÖRÜN SU AKIŞ DEBİSİ DAKİKADA 19 İLE 23 lt ARASINDADIR.
- YÖNLENDİRİCİ TAKIMI MS58 PİRİNÇTEN ÜRETİLMİŞTİR.
- TESİSAT BAĞLANTILARI G ½' DİR.
- EL DUŞU BAĞLANTISI G ½' DİR.

### Mix Bathroom Faucet

- OUR PRODUCT IS MADE OF MS58/MS63 BRASS LOW PRESSURE INGOTS
- SURFACE COATING IS 0,16mm CHROME COATING
- OUTPUT LENGTH 160mm
- 40 BAR PRESSURE RESISTANT CERAMIC CARTRIDGE USED
- WATER FLOW IS BETWEEN 19 AND 23 PER MINUTE
- THE ROYTER TOOLS WAS MADE BRASS'S
- INSTALLATION CONNECTIONS ARE G ½
- HAND SHOWER CONNECTIONS ARE G ½

12 | 3.950,00 ₺

Code: 43 2010 0935

**Mix Kuğu Mutfak Bataryası**

- ÜRÜNÜMÜZ MS58 PİRİNÇ MALZEMEDEN ÜRETİLMİŞTİR.
- YÜZEY KAPLAMASI 0,12 İLE 0,16 MİKRON KROM KAPLAMADIR.
- ÇIKIŞ UCU UZUNLUĞU 180 mm'DİR.
- ÇIKIŞ UCU YÜKSEKLİĞİ 320 mm'DİR.
- SU AKIŞ BORUSU ÇAPİ 22, SU AKIŞ BORUSU MS63 PİRİNÇTİR.
- 360 DERECE DÖNER BORULUDUR.
- 40 BAR BASINCA DAYANIKLI SERAMİK KARTUŞ KULLANILMAKTADIR.
- PERLATÖRÜN SU AKIŞ DEBİSİ DAKİKADA 12 İLE 18 İT ARASINDADIR.
- 3/8 M-10 40 BAR BASINCA DAYANIKLI ÇELİK ÖRGÜLÜ FLEX KULLANILMIŞTIR.

**Mix Kitchen Faucet**

- OUR PRODUCT IS MADE OF MS58 BRASS
- SURFACE COATING IS 0,16mm CHROME COATING
- OUTPUT LENGTH 180mm
- OUTPUT END PIPE HEIGHT IS 320mm
- THE DIAMETER FO THE PIPE IS 22, THE WATER FLOW PIPE MS63 IS BRASS
- 360 ROTARY PIPE
- 40 BAR PRESSURE RESISTANT CERAMIC CARTRIDGE USED
- WATER FLOW IS BETWEEN 13 AND 18 PER MINUTE
- G 3/8 M-10 40 BAR PRESSURE RESISTANT STEEL BRAIDED FLEX USED

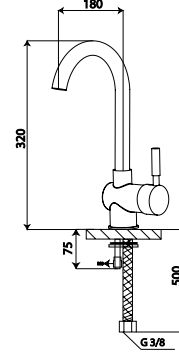

12 | 3.100,00 ₺

Code: 43 2010 0937

**Mix Kuğu Lavabo Bataryası**

- ÜRÜNÜMÜZ MS58 PİRİNÇ MALZEMEDEN ÜRETİLMİŞTİR.
- YÜZEY KAPLAMASI 0,16 MİKRON KROM KAPLAMADIR.
- ÇIKIŞ UCU UZUNLUĞU 120 mm'DİR.
- ÇIKIŞ UCU YÜKSEKLİĞİ 225 mm'DİR.
- SU AKIŞ BORUSU ÇAPİ 22, SU AKIŞ BORUSU MS63 PİRİNÇTİR.
- 360 DERECE DÖNER BORULUDUR.
- 40 BAR BASINCA DAYANIKLI SERAMİK KARTUŞ KULLANILMAKTADIR.
- PERLATÖRÜN SU AKIŞ DEBİSİ DAKİKADA 12 İLE 18 İT ARASINDADIR.
- 3/8 M-10 40 BAR BASINCA DAYANIKLI ÇELİK ÖRGÜLÜ FLEX KULLANILMIŞTIR.

**Mix Basin Faucet**

- OUR PRODUCT IS MADE OF MS58 BRASS
- SURFACE COATING IS 0,16mm CHROME COATING
- OUTPUT LENGTH 120mm
- OUTPUT END PIPE HEIGHT IS 225mm
- THE DIAMETER FO THE PIPE IS 18, THE WATER FLOW PIPE MS63 IS BRASS
- 360 ROTARY PIPE
- 40 BAR PRESSURE RESISTANT CERAMIC CARTRIDGE USED
- WATER FLOW IS BETWEEN 13 AND 18 PER MINUTE
- G 3/8 M-10 40 BAR PRESSURE RESISTANT STEEL BRAIDED FLEX USED

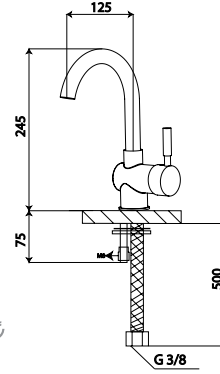

12 | 3.100,00 ₺

Code: 43 2010 0938

**Mix Lavabo Bataryası**

- ÜRÜNÜMÜZ MS58/MS63 ORANINDA ALÇAK BASINÇ PİRİNÇ KÜLÇEDEN ÜRETİLMİŞTİR.
- YÜZEY KAPLAMASI 0,12 İLE 0,16 MİKRON KROM KAPLAMADIR.
- ÇIKIŞ UCU UZUNLUĞU 120 mm'DİR.
- ÜRÜN YÜKSEKLİĞİ 165 mm'DİR.
- 40 BAR BASINCA DAYANIKLI SERAMİK KARTUŞ KULLANILMAKTADIR.
- PERLATÖRÜN SU AKIŞ DEBİSİ DAKİKADA 19 İLE 23 İT ARASINDADIR.
- 3/8 M-10 40 BAR BASINCA DAYANIKLI ÇELİK ÖRGÜLÜ FLEX KULLANILMIŞTIR.

**Mix Basin Faucet**

- OUR PRODUCT IS MADE OF MS58/MS63 BRASS LOW PRESSURE INGOTS
- SURFACE COATING IS 0,16mm CHROME COATING
- OUTPUT LENGTH 120 mm
- PRODUCT HEIGHT 165 mm
- 40 BAR PRESSURE RESISTANT CERAMIC CARTRIDGE USED
- WATER FLOW IS BETWEEN 19 AND 23 PER MINUTE
- G 3/8 M-10 40 BAR PRESSURE RESISTANT STEEL BRAIDED FLEX USED

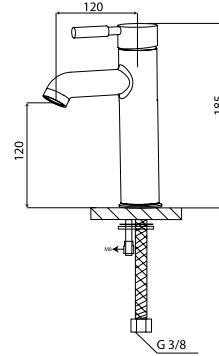

12 | 3.650,00 ₺

Code: 43 2010 0936

**Mix Yüksek Çanak Lavabo Bataryası**

- ÜRÜNÜMÜZ MS58/MS63 ORANINDA ALÇAK BASINÇ PİRİNÇ KÜLÇEDEN ÜRETİLMİŞTİR.
- YÜZEY KAPLAMASI 0,12 İLE 0,16 MİKRON KROM KAPLAMADIR.
- YÜZEY KAPLAMASI ÖZEL ALTIN BOYADIR.
- YÜZEY KAPLAMASI PULVER 916 BOYADIR.
- ÇIKIŞ UCU UZUNLUĞU 120 mm'DİR.
- ÜRÜN YÜKSEKLİĞİ 360 mm'DİR.
- 40 BAR BASINCA DAYANIKLI SERAMİK KARTUŞ KULLANILMAKTADIR.
- PERLATÖRÜN SU AKIŞ DEBİSİ DAKİKADA 19 İLE 23 İT ARASINDADIR.
- 3/8 M-10 40 BAR BASINCA DAYANIKLI ÇELİK ÖRGÜLÜ FLEX KULLANILMIŞTIR.

**Mix High Basin Faucet**

- OUR PRODUCT IS MADE OF MS58/MS63 BRASS LOW PRESSURE INGOTS
- SURFACE COATING IS 0,16mm CHROME COATING
- SURFACE COATING IS SPECIAL GOLD PAINT.
- SURFACE COATING IS PAINTED 916.
- OUTPUT LENGTH 120 mm
- PRODUCT HEIGHT 360 mm
- 40 BAR PRESSURE RESISTANT CERAMIC CARTRIDGE USED
- WATER FLOW IS BETWEEN 19 AND 23 PER MINUTE
- G 3/8 M-10 40 BAR PRESSURE RESISTANT STEEL BRAIDED FLEX USED

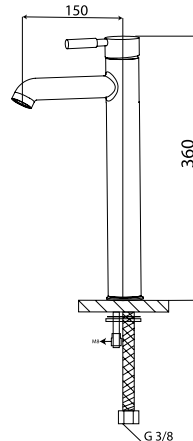

9 | 5.400,00 ₺

Code: 43 2010 0939



## MAT SİYAH

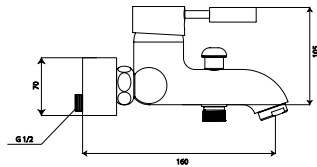

### Mix Banyo Bataryası

- ÜRÜNÜMÜZ MS58/MS63 ORANINDA ALÇAK BASINÇ PİRİNÇ KÜLÇEDEN ÜRETİLMİŞTİR.
- YÜZEY KAPLAMASI 0,12 İLE 0,16 MİKRON KROM KAPLAMADIR.
- ÇIKIŞ UCU UZUNLUĞU 160 mm'DİR.
- 40 BAR BASINCA DAYANIKLI SERAMİK KARTUŞ KULLANILMAKTADIR.
- PERLATÖRÜN SU AKIŞ DEBİSİ DAKİKADA 19 İLE 23 lt ARASINDADIR.
- YÖNLENDİRİCİ TAKIMI MS58 PİRİNÇTEN ÜRETİLMİŞTİR.
- TESİSAT BAĞLANTILARI G ½' DİR.
- EL DUŞU BAĞLANTISI G ½' DİR.

### Mix Bathroom Faucet

- OUR PRODUCT IS MADE OF MS58/MS63 BRASS LOW PRESSURE INGOTS
- SURFACE COATING IS 0,16mm CHROME COATING
- OUTPUT LENGTH 160mm
- 40 BAR PRESSURE RESISTANT CERAMIC CARTRIDGE USED
- WATER FLOW IS BETWEEN 19 AND 23 PER MINUTE
- THE ROYTER TOOLS WAS MADE BRASS'S
- INSTALLATION CONNECTIONS ARE G ½
- HAND SHOWER CONNECTIONS ARE G ½

12 | 3.290,00 ₺

Code: 43 2010 0900



**Mix Kuğu Mutfak Bataryası**

- ÜRÜNÜMÜZ MS58 PİRİNÇ MALZEMEDEN ÜRETİLMİŞTİR.
- YÜZEY KAPLAMASI 0,12 İLE 0,16 MİKRON KROM KAPLAMADIR.
- ÇIKIŞ UCU UZUNLUĞU 180 mm'DİR.
- ÇIKIŞ UCU YÜKSEKLİĞİ 320 mm'DİR.
- SU AKIŞ BORUSU ÇAPİ 22, SU AKIŞ BORUSU MS63 PİRİNÇTİR.
- 360 DERECE DÖNER BORULUDUR.
- 40 BAR BASINCA DAYANIKLI SERAMİK KARTUŞ KULLANILMAKTADIR.
- PERLATÖRÜN SU AKIŞ DEBİSİ DAKİKADA 12 İLE 18 lt ARASINDADIR.
- 3/8 M-10 40 BAR BASINCA DAYANIKLI ÇELİK ÖRGÜLÜ FLEX KULLANILMIŞTIR.

**Mix Kitchen Faucet**

- OUR PRODUCT IS MADE OF MS58 BRASS
- SURFACE COATING IS 0,16mm CHROME COATING
- OUTPUT LENGTH 180mm
- OUTPUT END PIPE HEIGHT IS 320mm
- THE DIAMETER FO THE PIPE IS 22, THE WATER FLOW PIPE MS63 IS BRASS
- 360 ROTARY PIPE
- 40 BAR PRESSURE RESISTANT CERAMIC CARTRIDGE USED
- WATER FLOW IS BETWEEN 13 AND 18 PER MINUTE
- G 3/8 M-10 40 BAR PRESSURE RESISTANT STEEL BRAIDED FLEX USED

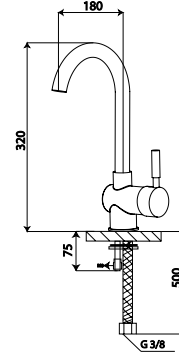

12 | 2.490,00 ₺

Code: 43 2010 0902

MAT SİYAH

**Mix Kuğu Lavabo Bataryası**

- ÜRÜNÜMÜZ MS58 PİRİNÇ MALZEMEDEN ÜRETİLMİŞTİR.
- YÜZEY KAPLAMASI 0,16 MİKRON KROM KAPLAMADIR.
- ÇIKIŞ UCU UZUNLUĞU 120 mm'DİR.
- ÇIKIŞ UCU YÜKSEKLİĞİ 225 mm'DİR.
- SU AKIŞ BORUSU ÇAPİ 22, SU AKIŞ BORUSU MS63 PİRİNÇTİR.
- 360 DERECE DÖNER BORULUDUR.
- 40 BAR BASINCA DAYANIKLI SERAMİK KARTUŞ KULLANILMAKTADIR.
- PERLATÖRÜN SU AKIŞ DEBİSİ DAKİKADA 12 İLE 18 lt ARASINDADIR.
- 3/8 M-10 40 BAR BASINCA DAYANIKLI ÇELİK ÖRGÜLÜ FLEX KULLANILMIŞTIR.

**Mix Basin Faucet**

- OUR PRODUCT IS MADE OF MS58 BRASS
- SURFACE COATING IS 0,16mm CHROME COATING
- OUTPUT LENGTH 120mm
- OUTPUT END PIPE HEIGHT IS 225mm
- THE DIAMETER FO THE PIPE IS 18, THE WATER FLOW PIPE MS63 IS BRASS
- 360 ROTARY PIPE
- 40 BAR PRESSURE RESISTANT CERAMIC CARTRIDGE USED
- WATER FLOW IS BETWEEN 13 AND 18 PER MINUTE
- G 3/8 M-10 40 BAR PRESSURE RESISTANT STEEL BRAIDED FLEX USED

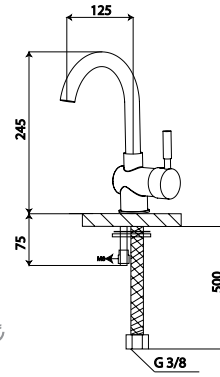

12 | 2.490,00 ₺

Code: 43 2010 0903

**Mix Lavabo Bataryası**

- ÜRÜNÜMÜZ MS58/MS63 ORANINDA ALÇAK BASINÇ PİRİNÇ KÜLÇEDEN ÜRETİLMİŞTİR.
- YÜZEY KAPLAMASI 0,12 İLE 0,16 MİKRON KROM KAPLAMADIR.
- ÇIKIŞ UCU UZUNLUĞU 120 mm'DİR.
- ÜRÜN YÜKSEKLİĞİ 165 mm'DİR.
- 40 BAR BASINCA DAYANIKLI SERAMİK KARTUŞ KULLANILMAKTADIR.
- PERLATÖRÜN SU AKIŞ DEBİSİ DAKİKADA 19 İLE 23 lt ARASINDADIR.
- 3/8 M-10 40 BAR BASINCA DAYANIKLI ÇELİK ÖRGÜLÜ FLEX KULLANILMIŞTIR.

**Mix Basin Faucet**

- OUR PRODUCT IS MADE OF MS58/MS63 BRASS LOW PRESSURE INGOTS
- SURFACE COATING IS 0,16mm CHROME COATING
- OUTPUT LENGTH 120 mm
- PRODUCT HEIGHT 165 mm
- 40 BAR PRESSURE RESISTANT CERAMIC CARTRIDGE USED
- WATER FLOW IS BETWEEN 19 AND 23 PER MINUTE
- G 3/8 M-10 40 BAR PRESSURE RESISTANT STEEL BRAIDED FLEX USED

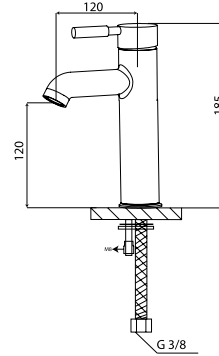

12 | 2.990,00 ₺

Code: 43 2010 0901

**Mix Yüksek Çanak Lavabo Bataryası**

- ÜRÜNÜMÜZ MS58/MS63 ORANINDA ALÇAK BASINÇ PİRİNÇ KÜLÇEDEN ÜRETİLMİŞTİR.
- YÜZEY KAPLAMASI 0,12 İLE 0,16 MİKRON KROM KAPLAMADIR.
- YÜZEY KAPLAMASI ÖZEL ALTIN BOYADIR.
- YÜZEY KAPLAMASI PULVER 916 BOYADIR.
- ÇIKIŞ UCU UZUNLUĞU 120 mm'DİR.
- ÜRÜN YÜKSEKLİĞİ 360 mm'DİR.
- 40 BAR BASINCA DAYANIKLI SERAMİK KARTUŞ KULLANILMAKTADIR.
- PERLATÖRÜN SU AKIŞ DEBİSİ DAKİKADA 19 İLE 23 lt ARASINDADIR.
- 3/8 M-10 40 BAR BASINCA DAYANIKLI ÇELİK ÖRGÜLÜ FLEX KULLANILMIŞTIR.

**Mix High Basin Faucet**

- OUR PRODUCT IS MADE OF MS58/MS63 BRASS LOW PRESSURE INGOTS
- SURFACE COATING IS 0,16mm CHROME COATING
- SURFACE COATING IS SPECIAL GOLD PAINT.
- SURFACE COATING IS PAINTED 916.
- OUTPUT LENGTH 120 mm
- PRODUCT HEIGHT 360 mm
- 40 BAR PRESSURE RESISTANT CERAMIC CARTRIDGE USED
- WATER FLOW IS BETWEEN 19 AND 23 PER MINUTE
- G 3/8 M-10 40 BAR PRESSURE RESISTANT STEEL BRAIDED FLEX USED

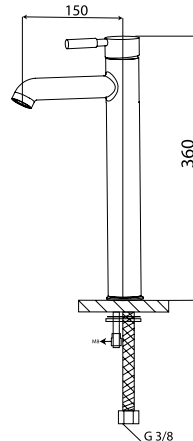

9 | 3.990,00 ₺

Code: 43 2010 0908





## MAT BEYAZ

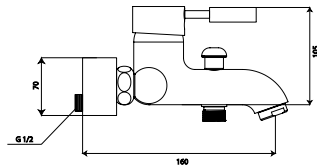

### Mix Banyo Bataryası

- ÜRÜNÜMÜZ MS58/MS63 ORANINDA ALÇAK BASINÇ PİRİNÇ KÜLÇEDEN ÜRETİLMİŞTİR.
- YÜZEY KAPLAMASI 0,12 İLE 0,16 MİKRON KROM KAPLAMADIR.
- ÇIKIŞ UCU UZUNLUĞU 160 mm'DİR.
- 40 BAR BASINCA DAYANIKLI SERAMİK KARTUŞ KULLANILMAKTADIR.
- PERLATÖRÜN SU AKIŞ DEBİSİ DAKİKADA 19 İLE 23 lt ARASINDADIR.
- YÖNLENDİRİCİ TAKIMI MS58 PİRİNÇTEN ÜRETİLMİŞTİR.
- TESİSAT BAĞLANTILARI G ½' DİR.
- EL DUŞU BAĞLANTISI G ½' DİR.

### Mix Bathroom Faucet

- OUR PRODUCT IS MADE OF MS58/MS63 BRASS LOW PRESSURE INGOTS
- SURFACE COATING IS 0,16mm CHROME COATING
- OUTPUT LENGTH 160mm
- 40 BAR PRESSURE RESISTANT CERAMIC CARTRIDGE USED
- WATER FLOW IS BETWEEN 19 AND 23 PER MINUTE
- THE ROYTER TOOLS WAS MADE BRASS'S
- INSTALLATION CONNECTIONS ARE G ½
- HAND SHOWER CONNECTIONS ARE G ½

12 | 3.290,00 ₺

Code: 43 2010 0904

**Mix Kuğu Mutfak Bataryası**

- ÜRÜNÜMÜZ MS58 PİRİNÇ MALZEMEDEN ÜRETİLMİŞTİR.
- YÜZEY KAPLAMASI 0,12 İLE 0,16 MİKRON KROM KAPLAMADIR.
- ÇIKIŞ UCU UZUNLUĞU 180 mm'DİR.
- ÇIKIŞ UCU YÜKSEKLİĞİ 320 mm'DİR.
- SU AKIŞ BORUSU ÇAPİ 22, SU AKIŞ BORUSU MS63 PİRİNÇTİR.
- 360 DERECE DÖNER BORULUDUR.
- 40 BAR BASINCA DAYANIKLI SERAMİK KARTUŞ KULLANILMAKTADIR.
- PERLATÖRÜN SU AKIŞ DEBİSİ DAKİKADA 12 İLE 18 lt ARASINDADIR.
- 3/8 M-10 40 BAR BASINCA DAYANIKLI ÇELİK ÖRGÜLÜ FLEX KULLANILMIŞTIR.

**Mix Kitchen Faucet**

- OUR PRODUCT IS MADE OF MS58 BRASS
- SURFACE COATING IS 0,16mm CHROME COATING
- OUTPUT LENGTH 180mm
- OUTPUT END PIPE HEIGHT IS 320mm
- THE DIAMETER FO THE PIPE IS 22, THE WATER FLOW PIPE MS63 IS BRASS
- 360 ROTARY PIPE
- 40 BAR PRESSURE RESISTANT CERAMIC CARTRIDGE USED
- WATER FLOW IS BETWEEN 13 AND 18 PER MINUTE
- G 3/8 M-10 40 BAR PRESSURE RESISTANT STEEL BRAIDED FLEX USED

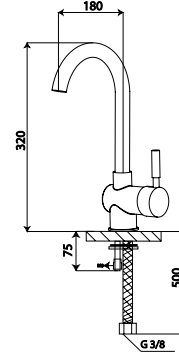

12 | 2.490,00 ₺

Code: 43 2010 0906

MAT BEYAZ

**Mix Kuğu Lavabo Bataryası**

- ÜRÜNÜMÜZ MS58 PİRİNÇ MALZEMEDEN ÜRETİLMİŞTİR.
- YÜZEY KAPLAMASI 0,16 MİKRON KROM KAPLAMADIR.
- ÇIKIŞ UCU UZUNLUĞU 120 mm'DİR.
- ÇIKIŞ UCU YÜKSEKLİĞİ 225 mm'DİR.
- SU AKIŞ BORUSU ÇAPİ 22, SU AKIŞ BORUSU MS63 PİRİNÇTİR.
- 360 DERECE DÖNER BORULUDUR.
- 40 BAR BASINCA DAYANIKLI SERAMİK KARTUŞ KULLANILMAKTADIR.
- PERLATÖRÜN SU AKIŞ DEBİSİ DAKİKADA 12 İLE 18 lt ARASINDADIR.
- 3/8 M-10 40 BAR BASINCA DAYANIKLI ÇELİK ÖRGÜLÜ FLEX KULLANILMIŞTIR.

**Mix Basin Faucet**

- OUR PRODUCT IS MADE OF MS58 BRASS
- SURFACE COATING IS 0,16mm CHROME COATING
- OUTPUT LENGTH 120mm
- OUTPUT END PIPE HEIGHT IS 225mm
- THE DIAMETER FO THE PIPE IS 18, THE WATER FLOW PIPE MS63 IS BRASS
- 360 ROTARY PIPE
- 40 BAR PRESSURE RESISTANT CERAMIC CARTRIDGE USED
- WATER FLOW IS BETWEEN 13 AND 18 PER MINUTE
- G 3/8 M-10 40 BAR PRESSURE RESISTANT STEEL BRAIDED FLEX USED

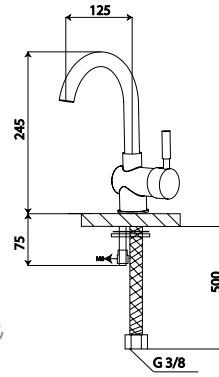

12 | 2.490,00 ₺

Code: 43 2010 0907

**Mix Lavabo Bataryası**

- ÜRÜNÜMÜZ MS58/MS63 ORANINDA ALÇAK BASINÇ PİRİNÇ KÜLÇEDEN ÜRETİLMİŞTİR.
- YÜZEY KAPLAMASI 0,12 İLE 0,16 MİKRON KROM KAPLAMADIR.
- ÇIKIŞ UCU UZUNLUĞU 120 mm'DİR.
- ÜRÜN YÜKSEKLİĞİ 165 mm'DİR.
- 40 BAR BASINCA DAYANIKLI SERAMİK KARTUŞ KULLANILMAKTADIR.
- PERLATÖRÜN SU AKIŞ DEBİSİ DAKİKADA 19 İLE 23 lt ARASINDADIR.
- 3/8 M-10 40 BAR BASINCA DAYANIKLI ÇELİK ÖRGÜLÜ FLEX KULLANILMIŞTIR.

**Mix Basin Faucet**

- OUR PRODUCT IS MADE OF MS58/MS63 BRASS LOW PRESSURE INGOTS
- SURFACE COATING IS 0,16mm CHROME COATING
- OUTPUT LENGTH 120 mm
- PRODUCT HEIGHT 165 mm
- 40 BAR PRESSURE RESISTANT CERAMIC CARTRIDGE USED
- WATER FLOW IS BETWEEN 19 AND 23 PER MINUTE
- G 3/8 M-10 40 BAR PRESSURE RESISTANT STEEL BRAIDED FLEX USED

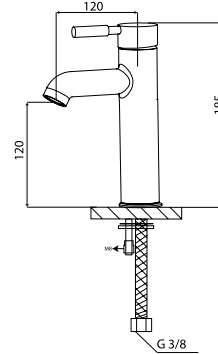

12 | 2.990,00 ₺

Code: 43 2010 0905

**Mix Yüksek Çanak Lavabo Bataryası**

- ÜRÜNÜMÜZ MS58/MS63 ORANINDA ALÇAK BASINÇ PİRİNÇ KÜLÇEDEN ÜRETİLMİŞTİR.
- YÜZEY KAPLAMASI 0,12 İLE 0,16 MİKRON KROM KAPLAMADIR.
- YÜZEY KAPLAMASI ÖZEL ALTIN BOYADIR.
- YÜZEY KAPLAMASI PULVER 916 BOYADIR.
- ÇIKIŞ UCU UZUNLUĞU 120 mm'DİR.
- ÜRÜN YÜKSEKLİĞİ 360 mm'DİR.
- 40 BAR BASINCA DAYANIKLI SERAMİK KARTUŞ KULLANILMAKTADIR.
- PERLATÖRÜN SU AKIŞ DEBİSİ DAKİKADA 19 İLE 23 lt ARASINDADIR.
- 3/8 M-10 40 BAR BASINCA DAYANIKLI ÇELİK ÖRGÜLÜ FLEX KULLANILMIŞTIR.

**Mix High Basin Faucet**

- OUR PRODUCT IS MADE OF MS58/MS63 BRASS LOW PRESSURE INGOTS
- SURFACE COATING IS 0,16mm CHROME COATING
- SURFACE COATING IS SPECIAL GOLD PAINT.
- SURFACE COATING IS PAINTED 916.
- OUTPUT LENGTH 120 mm
- PRODUCT HEIGHT 360 mm
- 40 BAR PRESSURE RESISTANT CERAMIC CARTRIDGE USED
- WATER FLOW IS BETWEEN 19 AND 23 PER MINUTE
- G 3/8 M-10 40 BAR PRESSURE RESISTANT STEEL BRAIDED FLEX USED

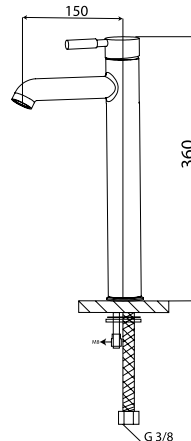

9 | 3.990,00 ₺

Code: 43 2010 0909





aceser®



GÜVENİLİR ÜRÜN

# ENDÜSTRİYEL SİRALLİ MUTFAK BATARYASI

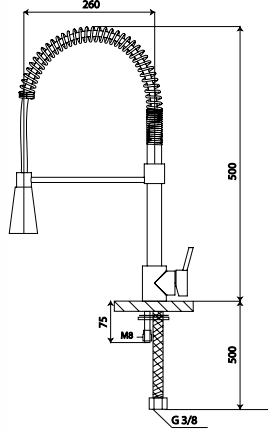

## Tekli Endüstriyel Mutfak Bataryası

- ÜRÜNÜMÜZ MS58 PİRİNÇ MALZEMEDEN ÜRETİLMİŞTİR.
- YÜZEY KAPLAMASI 0,12 İLE 0,16 MİKRON KROM KAPLAMADIR.
- ÇIKIŞ UCU UZUNLUĞU 260 mm'DİR.
- ÇIKIŞ UCU YÜKSEKLİĞİ 500 mm'DİR.
- BURKULMAZ 50cm SİRALLİ
- FONKSİYONLU EL DUŞU
- 360 DERECE DÖNER YAYLI ÇIKIŞ UCU
- 40 BAR BASINCA DAYANIKLI SERAMİK KARTUŞ KULLANILMAKTADIR.
- 3/8 M-10 40 BAR BASINCA DAYANIKLI ÇELİK ÖRGÜLÜ FLEX KULLANILMIŞTIR.

## Smart Kitchen Faucet

- OUR PRODUCT IS MADE OF MS58 BRASS
- SURFACE COATING IS 0,16mm CHROME COATING
- OUTPUT LENGTH 260mm
- OUTPUT END PIPE HEIGHT IS 500mm
- NON-BUCKLING 50cm SPIRALLİ
- FUNCTIONAL HAND SHOWER
- 360 DEGREE ROTARY SPRING OUTPUT TIP
- 40 BAR PRESSURE RESISTANT CERAMIC CARTRIDGE USED
- G 3/8 M-10 40 BAR PRESSURE RESISTANT STEEL BRAIDED FLEX USED

4 | 5.103,00 ₺

Code: 43 2010 0830

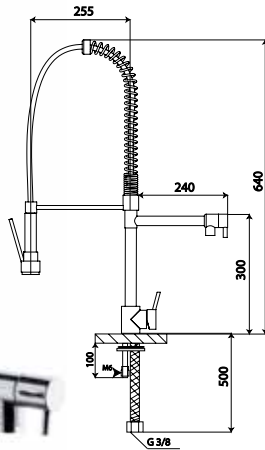

## Çiftli Endüstriyel Mutfak Bataryası

- ÜRÜNÜMÜZ MS58 PİRİNÇ MALZEMEDEN ÜRETİLMİŞTİR.
- YÜZEY KAPLAMASI 0,12 İLE 0,16 MİKRON KROM KAPLAMADIR.
- ÇIKIŞ UCU UZUNLUĞU 255 mm'DİR.
- ÇIKIŞ UCU YÜKSEKLİĞİ 640 mm'DİR.
- BURKULMAZ 50cm SİRALLİ
- FONKSİYONLU EL DUŞU
- 360 DERECE DÖNER YAYLI ÇIKIŞ UCU
- 40 BAR BASINCA DAYANIKLI SERAMİK KARTUŞ KULLANILMAKTADIR.
- 3/8 M-10 40 BAR BASINCA DAYANIKLI ÇELİK ÖRGÜLÜ FLEX KULLANILMIŞTIR.

## Double Industrial Kitchen Faucet

- OUR PRODUCT IS MADE OF MS58 BRASS
- SURFACE COATING IS 0,16mm CHROME COATING
- OUTPUT LENGTH 255mm
- OUTPUT END PIPE HEIGHT IS 640mm
- NON-BUCKLING 50cm SPIRALLİ
- FUNCTIONAL HAND SHOWER
- 360 DEGREE ROTARY SPRING OUTPUT TIP
- 40 BAR PRESSURE RESISTANT CERAMIC CARTRIDGE USED
- G 3/8 M-10 40 BAR PRESSURE RESISTANT STEEL BRAIDED FLEX USED

4 | 6.706,00 ₺

Code: 43 2010 0831

**Mix Kuğu Akıllı Mutfak Bataryası**

- ÜRÜNÜMÜZ MS58 PİRİNÇ MALZEMEDEN ÜRETİLMİŞTİR.
- YÜZEY KAPLAMASI 0,12 İLE 0,16 MİKRON KROM KAPLAMADIR.
- ÇIKIŞ UCU UZUNLUĞU 185 mm'DİR.
- ÇIKIŞ UCU YÜKSEKLİĞİ 345 mm'DİR.
- SU AKIŞ BORUSU ÇAPI 22mm, SU AKIŞ BORUSU MS63 PİRİNÇTİR.
- 360 DERECE DÖNER BORULUDUR.
- 40 BAR BASINCA DAYANIKLI SERAMİK KARTUŞ KULLANILMAKTADIR.
- PERLATÖRÜN SU AKIŞ DEBİSİ DAKİKADA 12 İLE 18 lt ARASINDADIR.
- 3/8 M-10 40 BAR BASINCA DAYANIKLI ÇELİK ÖRGÜLÜ FLEX KULLANILMIŞTIR.

**Smart Kitchen Faucet**

- OUR PRODUCT IS MADE OF MS58 BRASS
- SURFACE COATING IS 0,16mm CHROME COATING
- OUTPUT LENGTH 185mm
- OUTPUT END PIPE HEIGHT IS 345mm
- THE DIAMETER FO THE PIPE IS 22, THE WATER FLOW PIPE MS63 IS BRASS
- 360 ROTARY PIPE
- 40 BAR PRESSURE RESISTANT CERAMIC CARTRIDGE USED
- WATER FLOW IS BETWEEN 13 AND 18 PER MINUTE
- G 3/8 M-10 40 BAR PRESSURE RESISTANT STEEL BRAIDED FLEX USED

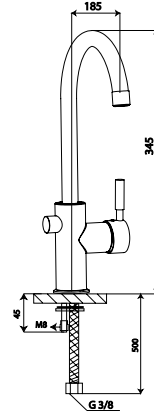

Ürünümüz  
Patentlidir

El Ayarlı  
Su Tasarruflu



12 | 3.046,00 ₺  
Code: 43 2010 0834

**Mix Kuğu Akıllı Lavabo Bataryası**

- ÜRÜNÜMÜZ MS58 PİRİNÇ MALZEMEDEN ÜRETİLMİŞTİR.
- YÜZEY KAPLAMASI 0,12 İLE 0,16 MİKRON KROM KAPLAMADIR.
- ÇIKIŞ UCU UZUNLUĞU 135 mm'DİR.
- ÇIKIŞ UCU YÜKSEKLİĞİ 280 mm'DİR.
- SU AKIŞ BORUSU ÇAPI 22mm, SU AKIŞ BORUSU MS63 PİRİNÇTİR.
- 360 DERECE DÖNER BORULUDUR.
- 40 BAR BASINCA DAYANIKLI SERAMİK KARTUŞ KULLANILMAKTADIR.
- PERLATÖRÜN SU AKIŞ DEBİSİ DAKİKADA 12 İLE 18 lt ARASINDADIR.
- 3/8 M-10 40 BAR BASINCA DAYANIKLI ÇELİK ÖRGÜLÜ FLEX KULLANILMIŞTIR.

**Smart Basin Faucet**

- OUR PRODUCT IS MADE OF MS58 BRASS
- SURFACE COATING IS 0,16mm CHROME COATING
- OUTPUT LENGTH 135mm
- OUTPUT END PIPE HEIGHT IS 280mm
- THE DIAMETER FO THE PIPE IS 22, THE WATER FLOW PIPE MS63 IS BRASS
- 360 ROTARY PIPE
- 40 BAR PRESSURE RESISTANT CERAMIC CARTRIDGE USED
- WATER FLOW IS BETWEEN 13 AND 18 PER MINUTE
- G 3/8 M-10 40 BAR PRESSURE RESISTANT STEEL BRAIDED FLEX USED

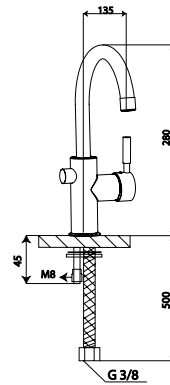

Ürünümüz  
Patentlidir

El Ayarlı  
Su Tasarruflu



12 | 3.046,00 ₺  
Code: 43 2010 0835

ROKA AKILLI OYNAR BAŐLİKLİ  
ANKASTRE  
MUTFAK BATARYASI

Yönlendirilebilen  
oynar başlık

360 derece  
döner borulu

*New design*

Su tasarrufu  
ayar düğmesi





## Krom

**Mix Kuğu Akıllı Oynar Başlıklı Mutfak Bataryası**  
Smart Kitchen Faucet

12 | 3.600,00 ₺

Code: 43 2010 0838



## Altın

**Mix Kuğu Akıllı Oynar Başlıklı Mutfak Bataryası**  
Smart Kitchen Faucet

4 | 4.990,00 ₺

Code: 43 2010 0931



## Saten

**Mix Kuğu Akıllı Oynar Başlıklı Mutfak Bataryası**  
Smart Kitchen Faucet

4 | 4.990,00 ₺

Code: 43 2010 0870



## İnci Siyah

**Mix Kuğu Akıllı Oynar Başlıklı Mutfak Bataryası**  
Smart Kitchen Faucet

12 | 4.990,00 ₺

Code: 43 2010 0930



## Mat Siyah

**Mix Kuğu Akıllı Oynar Başlıklı Mutfak Bataryası**  
Smart Kitchen Faucet

4 | 4.250,00 ₺

Code: 43 2010 0932



## Ross

**Mix Kuğu Akıllı Oynar Başlıklı Mutfak Bataryası**  
Smart Kitchen Faucet

4 | 4.990,00 ₺

Code: 43 2010 0934

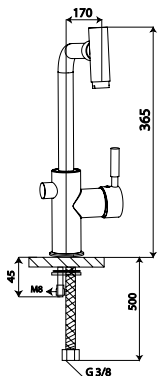

Ürünümüz  
Patentlidir

El Ayarlı  
Su Tasarruflu

### Mix Kuğu Akıllı Oynar Başlıklı Mutfak Bataryası

- ÜRÜNÜMÜZ MS58 PİRİNÇ MALZEMEDEN ÜRETİLMİŞTİR.
- YÜZEY KAPLAMASI 0,12 İLE 0,16 MİKRON KROM KAPLAMADIR.
- ÇIKIŞ UCU UZUNLUĞU 170 mm'DİR.
- ÇIKIŞ UCU YÜKSEKLİĞİ 365 mm'DİR.
- 2SU AKIŞ BORUSU ÇAPI 22mm, SU AKIŞ BORUSU MS63 PİRİNÇTİR.
- 360 DERECE DÖNER BORULUDUR.
- 40 BAR BASINCA DAYANIKLI SERAMİK KARTUŞ KULLANILMAKTADIR.
- PERLATÖRÜN SU AKIŞ DEBİSİ DAKİKADA 12 İLE 18 lt ARASINDADIR.
- 3/8 M-10 40 BAR BASINCA DAYANIKLI ÇELİK ÖRGÜLÜ FLEX KULLANILMIŞTIR.

### Smart Kitchen Faucet

- OUR PRODUCT IS MADE OF MS58 BRASS
- SURFACE COATING IS 0,16mm CHROME COATING
- OUTPUT LENGTH 170mm
- OUTPUT END PIPE HEIGHT IS 365mm
- THE DIAMETER FO THE PIPE IS 22, THE WATER FLOW PIPE MS63 IS BRASS
- 360 ROTARY PIPE
- 40 BAR PRESSURE RESISTANT CERAMIC CARTRIDGE USED
- WATER FLOW IS BETWEEN 13 AND 18 PER MINUTE
- G 3/8 M-10 40 BAR PRESSURE RESISTANT STEEL BRAIDED FLEX USED



Krom

**Mix Cobra Spiralli Basmalı  
Mutfak Bataryası**  
Mix Cobra Spiral Push-In  
Kitchen Faucet

9 | 3.900,00 ₺

Code: 43 2010 0839



Altın

**Mix Cobra Spiralli Basmalı  
Mutfak Bataryası**  
Mix Cobra Spiral Push-In  
Kitchen Faucet

9 | 4.990,00 ₺

Code: 43 2010 0895



Saten

**Mix Cobra Spiralli Basmalı  
Mutfak Bataryası**  
Mix Cobra Spiral Push-In  
Kitchen Faucet

9 | 4.990,00 ₺

Code: 43 2010 0896



İnci Siyah

**Mix Cobra Spiralli Basmalı  
Mutfak Bataryası**  
Mix Cobra Spiral Push-In  
Kitchen Faucet

9 | 4.990,00 ₺

Code: 43 2010 0927



Mat Siyah

**Mix Cobra Spiralli Basmalı  
Mutfak Bataryası**  
Mix Cobra Spiral Push-In  
Kitchen Faucet

9 | 4.250,00 ₺

Code: 43 2010 0894



Ross

**Mix Cobra Spiralli Basmalı  
Mutfak Bataryası**  
Mix Cobra Spiral Push-In  
Kitchen Faucet

9 | 4.990,00 ₺

Code: 43 2010 0940

- ÜRÜNÜMÜZ MS58 PİRİNÇ MALZEMEDEN ÜRETİLMİŞTİR.
- YÜZEY KAPLAMASI 0,12 İLE 0,16 MİKRON KROM KAPLAMADIR.
- ÇIKIŞ UCU UZUNLUĞU 150 mm'DİR.
- ÇIKIŞ UCU YÜKSEKLİĞİ 360 mm'DİR.
- BURKULMAZ 50cm SİRALLİ
- FONKSİYONLU EL DUŞU
- 360 DERECE DÖNER
- 40 BAR BASINCA DAYANIKLI SERAMİK KARTUŞ KULLANILMAKTADIR.
- 3/8 M-10 40 BAR BASINCA DAYANIKLI ÇELİK ÖRGÜLÜ FLEX KULLANILMIŞTIR.

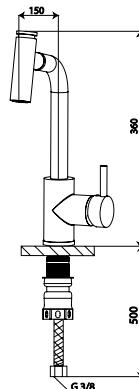

- OUR PRODUCT IS MADE OF MS58 BRASS
- SURFACE COATING IS 0,16mm CHROME COATING
- OUTPUT LENGTH 150mm
- OUTPUT END PIPE HEIGHT IS 360mm
- NON-BUCKLING 50cm SİRALLİ
- FUNCTIONAL HAND SHOWER
- 360 DEGREE ROTARY
- 40 BAR PRESSURE RESISTANT CERAMIC CARTRIDGE USED
- G 3/8 M-10 40 BAR PRESSURE RESISTANT STEEL BRAIDED FLEX USED





**Krom**

**Mix Kuğu Spiralli Basmalı  
Mutfak Bataryası**  
Mix Sink Spiral Push-In  
Chrome Kitchen Faucet

9 | 3.900,00 ₺

Code: 43 2010 0841



**Altın**

**Mix Kuğu Spiralli Basmalı  
Mutfak Bataryası**  
Mix Sink Spiral Push-In  
Chrome Kitchen Faucet

9 | 4.990,00 ₺

Code: 43 2010 0897



**Saten**

**Mix Kuğu Spiralli Basmalı  
Mutfak Bataryası**  
Mix Sink Spiral Push-In  
Chrome Kitchen Faucet

9 | 4.990,00 ₺

Code: 43 2010 0898



**İnci Siyah**

**Mix Kuğu Spiralli Basmalı  
Mutfak Bataryası**  
Mix Sink Spiral Push-In  
Chrome Kitchen Faucet

9 | 4.990,00 ₺

Code: 43 2010 0929



**Mat Siyah**

**Mix Kuğu Spiralli Basmalı  
Mutfak Bataryası**  
Mix Sink Spiral Push-In  
Chrome Kitchen Faucet

9 | 4.250,00 ₺

Code: 43 2010 0928



**Ross**

**Mix Kuğu Spiralli Basmalı  
Mutfak Bataryası**  
Mix Sink Spiral Push-In  
Chrome Kitchen Faucet

9 | 4.990,00 ₺

Code: 43 2010 0840

- ÜRÜNÜMÜZ MS58 PİRİNÇ MALZEMEDEN ÜRETİLMİŞTİR.
- YÜZEY KAPLAMASI 0,12 İLE 0,16 MİKRON KROM KAPLAMADIR.
- ÇIKIŞ UCU UZUNLUĞU 215 mm'DİR.
- ÇIKIŞ UCU YÜKSEKLİĞİ 485 mm'DİR.
- BURKULMAZ 50cm SİRALLİ
- FONKSİYONLU EL DUŞU
- 360 DERECE DÖNER
- 40 BAR BASINCA DAYANIKLI SERAMİK KARTUŞ KULLANILMAKTADIR.
- 3/8 M-10 40 BAR BASINCA DAYANIKLI ÇELİK ÖRGÜLÜ FLEX KULLANILMIŞTIR.

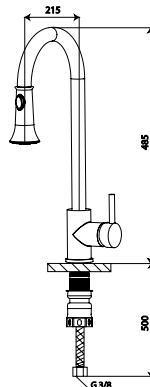

- OUR PRODUCT IS MADE OF MS58 BRASS
- SURFACE COATING IS 0,16mm CHROME COATING
- OUTPUT LENGTH 215mm
- OUTPUT END PIPE HEIGHT IS 485mm
- NON-BUCKLING 50cm SPIRALL
- FUNCTIONAL HAND SHOWER
- 360 DEGREE ROTARY
- 40 BAR PRESSURE RESISTANT CERAMIC CARTRIDGE USED
- G 3/8 M-10 40 BAR PRESSURE RESISTANT STEEL BRAIDED FLEX USED

## ROKA ÇİFTLİ & ARITMALI MUTFAK BATARYASI



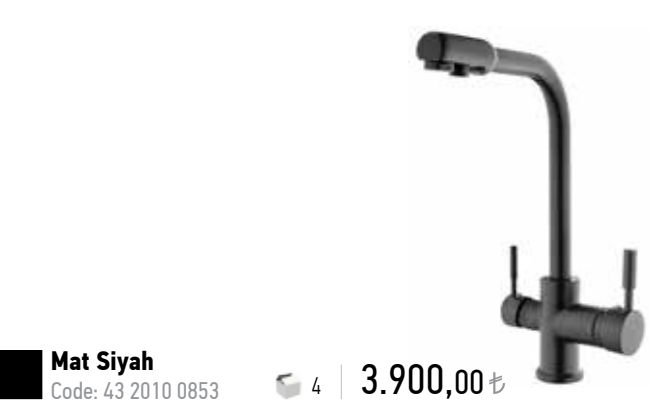

## Mix Kuğu Çift Çıkışlı Temiz Su Mutfak Bataryası

- ÜRÜNÜMÜZ MS58 PİRİNÇ MALZEMEDEN ÜRETİLMİŞTİR.
- YÜZEY KAPLAMASI 0,12 İLE 0,16 MİKRON KROM KAPLAMADIR.
- YÜZEY KAPLAMASI ÖZEL ALTIN BOYADIR.
- YÜZEY KAPLAMASI PULVER 916 BOYADIR.
- ÇIKIŞ UCU UZUNLUĞU 175 mm'DİR.
- 2. ÇIKIŞ UCU UZUNLUĞU 210 mm'DİR.
- ÇIKIŞ UCU YÜKSEKLİĞİ 330 mm'DİR.
- SU AKIŞ BORUSU ÇAPI 22mm, SU AKIŞ BORUSU MS63 PİRİNÇTİR.
- 360 DERECE DÖNER BORULUDUR.
- 40 BAR BASINCA DAYANIKLI SERAMİK KARTUŞ KULLANILMAKTADIR.
- PERLATÖRÜN SU AKIŞ DEBİSİ DAKİKADA 12 İLE 18 lt ARASINDADIR.
- 3/8 M-10 40 BAR BASINCA DAYANIKLI ÇELİK ÖRGÜLÜ FLEX KULLANILMIŞTIR.

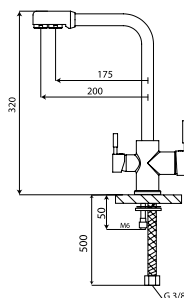

## Mix Clean Water Kitchen Faucet

- OUR PRODUCT IS MADE OF MS58 BRASS
- SURFACE COATING IS 0,16mm CHROME COATING
- SURFACE COATING IS SPECIAL GOLD PAINT.
- SURFACE COATING IS PAINTED 916.
- OUTPUT LENGTH 175mm
- SECOND OUTPUT LENGTH 210mm
- OUTPUT END PIPE HEIGHT IS 330mm
- THE DIAMETER FO THE PIPE IS 22, THE WATER FLOW PIPE MS63 IS BRASS
- 360 ROTARY PIPE
- 40 BAR PRESSURE RESISTANT CERAMIC CARTRIDGE USED
- WATER FLOW IS BETWEEN 13 AND 18 PER MINUTE
- G 3/8 M-10 40 BAR PRESSURE RESISTANT STEEL BRAIDED FLEX USED

## ROKA ÇİFTLİ & ARITMALI MUTFAK BATARYASI



## Mix Kuğu Çift Çıkışlı Temiz Su Mutfak Bataryası

- ÜRÜNÜMÜZ MS58 PİRİNÇ MALZEMEDEN ÜRETİLMİŞTİR.
- YÜZEY KAPLAMASI 0,12 İLE 0,16 MİKRON KROM KAPLAMADIR.
- YÜZEY KAPLAMASI ÖZEL ALTIN BOYADIR.
- YÜZEY KAPLAMASI PULVER 916 BOYADIR.
- ÇIKIŞ UCU UZUNLUĞU 175 mm'DİR.
- 2. ÇIKIŞ UCU UZUNLUĞU 210 mm'DİR.
- ÇIKIŞ UCU YÜKSEKLİĞİ 330 mm'DİR.
- SU AKIŞ BORUSU ÇAPI 22mm, SU AKIŞ BORUSU MS63 PİRİNÇTİR.
- 360 DERECE DÖNER BORULUDUR.
- 40 BAR BASINCA DAYANIKLI SERAMİK KARTUŞ KULLANILMAKTADIR.
- PERLATÖRÜN SU AKIŞ DEBİSİ DAKİKADA12 İLE 18 lt ARASINDADIR.
- 3/8 M-10 40 BAR BASINCA DAYANIKLI ÇELİK ÖRGÜLÜ FLEX KULLANILMIŞTIR.

## Mix Clean Water Kitchen Faucet

- OUR PRODUCT IS MADE OF MS58 BRASS
- SURFACE COATING IS 0,16mm CHROME COATING
- SURFACE COATING IS SPECIAL GOLD PAINT.
- SURFACE COATING IS PAINTED 916.
- OUTPUT LENGTH 175mm
- SECOND OUTPUT LENGTH 210mm
- OUTPUT END PIPE HEIGHT IS 330mm
- THE DIAMETER FO THE PIPE IS 22, THE WATER FLOW PIPE MS63 IS BRASS
- 360 ROTARY PIPE
- 40 BAR PRESSURE RESISTANT CERAMIC CARTRIDGE USED
- WATER FLOW IS BETWEEN 13 AND 18 PER MINUTE
- G 3/8 M-10 40 BAR PRESSURE RESISTANT STEEL BRAIDED FLEX USED

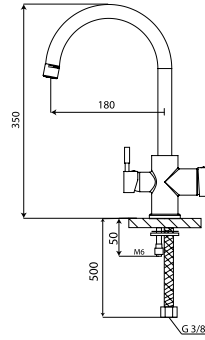

**Krom**  
Code: 43 2010 0842

8 | 2.999,00 ₺

Baston Borulu



Baston Borulu

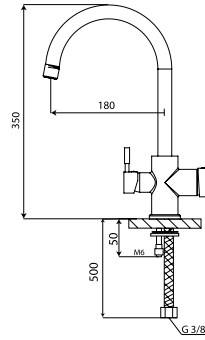

**Mat Siyah**  
Code: 43 2010 0912

8 | 3.500,00 ₺



## Mix Kuğu Çift Çıkışlı Temiz Su Mutfak Bataryası

- ÜRÜNÜMÜZ MS58 PİRİNÇ MALZEMEDEN ÜRETİLMİŞTİR.
- YÜZEY KAPLAMASI 0,12 İLE 0,16 MİKRON KROM KAPLAMADIR.
- YÜZEY KAPLAMASI ÖZEL ALTIN BOYADIR.
- YÜZEY KAPLAMASI PULVER 916 BOYADIR.
- ÇIKIŞ UCU UZUNLUĞU 175 mm'DİR.
- 2. ÇIKIŞ UCU UZUNLUĞU 210 mm'DİR.
- ÇIKIŞ UCU YÜKSEKLİĞİ 330 mm'DİR.
- SU AKIŞ BORUSU ÇAPI 22mm, SU AKIŞ BORUSU MS63 PİRİNÇTİR.
- 360 DERECE DÖNER BORULUDUR.
- 40 BAR BASINCA DAYANIKLI SERAMİK KARTUŞ KULLANILMAKTADIR.
- PERLATÖRÜN SU AKIŞ DEBİSİ DAKİKADA12 İLE 18 lt ARASINDADIR.
- 3/8 M-10 40 BAR BASINCA DAYANIKLI ÇELİK ÖRGÜLÜ FLEX KULLANILMIŞTIR.

## Mix Clean Water Kitchen Faucet

- OUR PRODUCT IS MADE OF MS58 BRASS
- SURFACE COATING IS 0,16mm CHROME COATING
- SURFACE COATING IS SPECIAL GOLD PAINT.
- SURFACE COATING IS PAINTED 916.
- OUTPUT LENGTH 175mm
- SECOND OUTPUT LENGTH 210mm
- OUTPUT END PIPE HEIGHT IS 330mm
- THE DIAMETER FO THE PIPE IS 22, THE WATER FLOW PIPE MS63 IS BRASS
- 360 ROTARY PIPE
- 40 BAR PRESSURE RESISTANT CERAMIC CARTRIDGE USED
- WATER FLOW IS BETWEEN 13 AND 18 PER MINUTE
- G 3/8 M-10 40 BAR PRESSURE RESISTANT STEEL BRAIDED FLEX USED

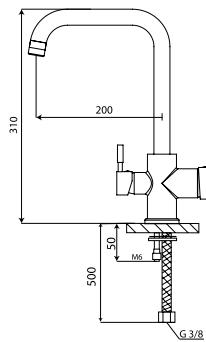

**Krom**  
Code: 43 2010 0843

8 | 2.999,00 ₺

L Borulu



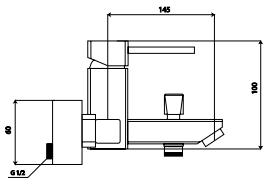

### Mix Banyo Bataryası

- ÜRÜNÜMÜZ MS58/MS63 ORANINDA ALÇAK BASINÇ PİRİNÇ KÜLÇEDEN ÜRETİLMİŞTİR.
- YÜZEY KAPLAMASI 0,12 İLE 0,16 MİKRON KROM KAPLAMADIR.
- ÇIKIŞ UCU UZUNLUĞU 200 mm'DİR.
- 40 BAR BASINCA DAYANIKLI SERAMİK KARTUŞ KULLANILMAKTADIR.
- PERLATÖRÜN SU AKIŞ DEBİSİ DAKİKADA 19 İLE 23 lt ARASINDADIR.
- YÖNLENDİRİCİ TAKIMI MS58 PİRİNÇTEN ÜRETİLMİŞTİR.
- TESİSAT BAĞLANTILARI G ½' DİR.
- EL DUŞU BAĞLANTISI G ½' DİR.

### Mix Bathroom Faucet

- OUR PRODUCT IS MADE OF MS58/MS63 BRASS LOW PRESSURE INGOTS
- SURFACE COATING IS 0,16mm CHROME COATING
- OUTPUT LENGTH 200mm
- 40 BAR PRESSURE RESISTANT CERAMIC CARTRIDGE USED
- WATER FLOW IS BETWEEN 19 AND 23 PER MINUTE
- THE ROYTER TOOLS WAS MADE BRASS'S
- INSTALLATION CONNECTIONS ARE G ½
- HAND SHOWER CONNECTIONS ARE G ½

12 | 3.810,00 ₺

Code: 41 2010 0601

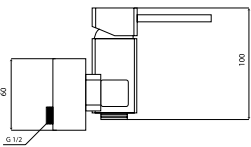

### Mix Duş Bataryası

- ÜRÜNÜMÜZ MS58/MS63 ORANINDA ALÇAK BASINÇ PİRİNÇ KÜLÇEDEN ÜRETİLMİŞTİR.
- YÜZEY KAPLAMASI 0,12 İLE 0,16 MİKRON KROM KAPLAMADIR.
- ÇIKIŞ UCU UZUNLUĞU 175 mm'DİR.
- 40 BAR BASINCA DAYANIKLI SERAMİK KARTUŞ KULLANILMAKTADIR.
- PERLATÖRÜN SU AKIŞ DEBİSİ DAKİKADA 19 İLE 23 lt ARASINDADIR.
- YÖNLENDİRİCİ TAKIMI MS58 PİRİNÇTEN ÜRETİLMİŞTİR.
- TESİSAT BAĞLANTILARI G ½' DİR.
- EL DUŞU BAĞLANTISI G ½' DİR.

### Mix Shower Faucet

- OUR PRODUCT IS MADE OF MS58/MS63 BRASS LOW PRESSURE INGOTS
- SURFACE COATING IS 0,16mm CHROME COATING
- OUTPUT LENGTH 175mm
- 40 BAR PRESSURE RESISTANT CERAMIC CARTRIDGE USED
- WATER FLOW IS BETWEEN 19 AND 23 PER MINUTE
- THE ROYTER TOOLS WAS MADE BRASS'S
- INSTALLATION CONNECTIONS ARE G ½
- HAND SHOWER CONNECTIONS ARE G ½

12 | 3.350,00 ₺

Code: 41 2010 0633

## Mix Kuğu Mutfak Bataryası

- ÜRÜNÜMÜZ MS58 PİRİNÇ MALZEMEDEN ÜRETİLMİŞTİR.
- YÜZEY KAPLAMASI 0,12 İLE 0,16 MİKRON KROM KAPLAMADIR.
- ÇIKIŞ UCU UZUNLUĞU 185 mm'DİR.
- ÇIKIŞ UCU YÜKSEKLİĞİ 340 mm'DİR.
- ÖZEL ÜRETİM PASLANMAZ BORU.
- 360 DERECE DÖNER BORULUDUR.
- 40 BAR BASINCA DAYANIKLI SERAMİK KARTUŞ KULLANILMAKTADIR.
- PERLATÖRÜN SU AKIŞ DEBİSİ DAKİKADA 12 İLE 18 lt ARASINDADIR.
- 3/8 M-10 40 BAR BASINCA DAYANIKLI ÇELİK ÖRGÜLÜ FLEX KULLANILMIŞTIR.

## Mix Kitchen Faucet

- OUR PRODUCT IS MADE OF MS58 BRASS
- SURFACE COATING IS 0,16mm CHROME COATING
- OUTPUT LENGTH 185mm
- OUTPUT END PIPE HEIGHT IS 340mm
- SPECIAL PRODUCTION STAINLESS PIPE
- 360 ROTARY PIPE
- 40 BAR PRESSURE RESISTANT CERAMIC CARTRIDGE USED
- WATER FLOW IS BETWEEN 13 AND 18 PER MINUTE
- G 3/8 M-10 40 BAR PRESSURE RESISTANT STEEL BRAIDED FLEX USED

12 | 2.250,00 ₺  
Code: 41 2010 0602

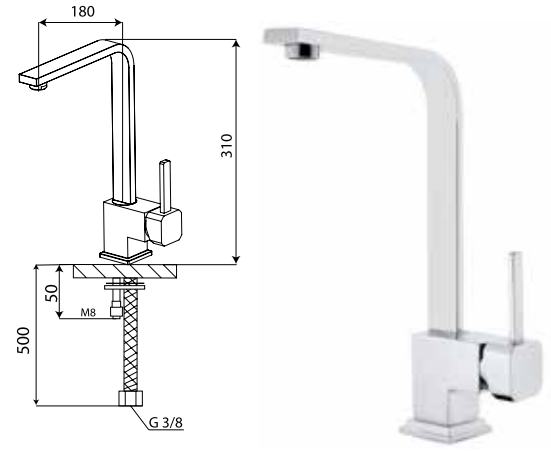

## Mix Kuğu Lavabo Bataryası

- ÜRÜNÜMÜZ MS58 PİRİNÇ MALZEMEDEN ÜRETİLMİŞTİR.
- YÜZEY KAPLAMASI 0,12 İLE 0,16 MİKRON KROM KAPLAMADIR.
- ÇIKIŞ UCU UZUNLUĞU 135 mm'DİR.
- ÇIKIŞ UCU YÜKSEKLİĞİ 270 mm'DİR.
- ÖZEL ÜRETİM PASLANMAZ BORU.
- 360 DERECE DÖNER BORULUDUR.
- 40 BAR BASINCA DAYANIKLI SERAMİK KARTUŞ KULLANILMAKTADIR.
- PERLATÖRÜN SU AKIŞ DEBİSİ DAKİKADA 12 İLE 18 lt ARASINDADIR.
- 3/8 M-10 40 BAR BASINCA DAYANIKLI ÇELİK ÖRGÜLÜ FLEX KULLANILMIŞTIR.

## Mix Basin Faucet

- OUR PRODUCT IS MADE OF MS58 BRASS
- SURFACE COATING IS 0,16mm CHROME COATING
- OUTPUT LENGTH 135mm
- OUTPUT END PIPE HEIGHT IS 270mm
- SPECIAL PRODUCTION STAINLESS PIPE
- 360 ROTARY PIPE
- 40 BAR PRESSURE RESISTANT CERAMIC CARTRIDGE USED
- WATER FLOW IS BETWEEN 13 AND 18 PER MINUTE
- G 3/8 M-10 40 BAR PRESSURE RESISTANT STEEL BRAIDED FLEX USED

12 | 2.250,00 ₺  
Code: 41 2010 0614

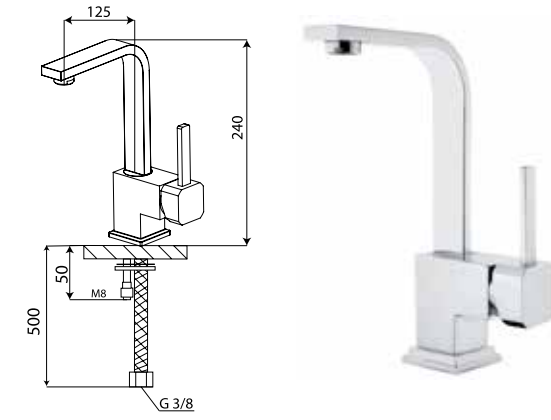

## Mix Sabit Lavabo Bataryası

- ÜRÜNÜMÜZ MS58 PİRİNÇ MALZEMEDEN ÜRETİLMİŞTİR.
- YÜZEY KAPLAMASI 0,12 İLE 0,16 MİKRON KROM KAPLAMADIR.
- ÇIKIŞ UCU UZUNLUĞU 120 mm'DİR.
- ÜRÜN YÜKSEKLİĞİ 165 mm'DİR.
- 40 BAR BASINCA DAYANIKLI SERAMİK KARTUŞ KULLANILMAKTADIR.
- PERLATÖRÜN SU AKIŞ DEBİSİ DAKİKADA 12 İLE 18 lt ARASINDADIR.
- 3/8 M-10 40 BAR BASINCA DAYANIKLI ÇELİK ÖRGÜLÜ FLEX KULLANILMIŞTIR.

## Mix Basin Faucet

- OUR PRODUCT IS MADE OF MS58 BRASS
- SURFACE COATING IS 0,16mm CHROME COATING
- OUTPUT LENGTH 120mm
- PRODUCT HEIGHT 165mm
- 40 BAR PRESSURE RESISTANT CERAMIC CARTRIDGE USED
- WATER FLOW IS BETWEEN 13 AND 18 PER MINUTE
- G 3/8 M-10 40 BAR PRESSURE RESISTANT STEEL BRAIDED FLEX USED

12 | 2.690,00 ₺  
Code: 41 2010 0603

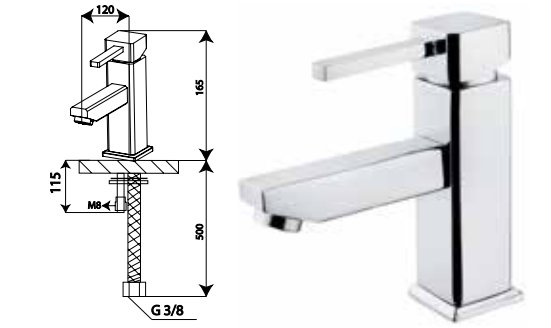

## Mix Çanak Lavabo Bataryası

- ÜRÜNÜMÜZ MS58 PİRİNÇ MALZEMEDEN ÜRETİLMİŞTİR.
- YÜZEY KAPLAMASI 0,12 İLE 0,16 MİKRON KROM KAPLAMADIR.
- YÜZEY KAPLAMASI ÖZEL ALTIN BOYADIR.
- YÜZEY KAPLAMASI PULVER 916 BOYADIR.
- ÇIKIŞ UCU UZUNLUĞU 120 mm'DİR.
- ÜRÜN YÜKSEKLİĞİ 350 mm'DİR.
- 40 BAR BASINCA DAYANIKLI SERAMİK KARTUŞ KULLANILMAKTADIR.
- PERLATÖRÜN SU AKIŞ DEBİSİ DAKİKADA 12 İLE 18 lt ARASINDADIR.
- 3/8 M-10 40 BAR BASINCA DAYANIKLI ÇELİK ÖRGÜLÜ FLEX KULLANILMIŞTIR.

## Mix High Basin Faucet

- OUR PRODUCT IS MADE OF MS58 BRASS
- SURFACE COATING IS 0,16mm CHROME COATING
- SURFACE COATING IS SPECIAL GOLD PAINT.
- SURFACE COATING IS PAINTED 916.
- OUTPUT LENGTH 120mm
- PRODUCT HEIGHT 350mm
- 40 BAR PRESSURE RESISTANT CERAMIC CARTRIDGE USED
- WATER FLOW IS BETWEEN 13 AND 18 PER MINUTE
- G 3/8 M-10 40 BAR PRESSURE RESISTANT STEEL BRAIDED FLEX USED

9 | 5.000,00 ₺  
Code: 41 2010 0605

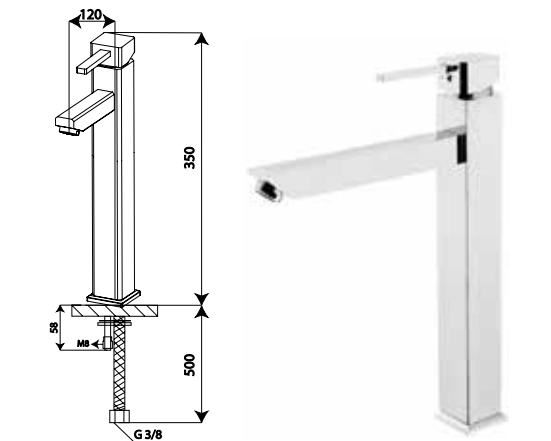

MAT SİYAH

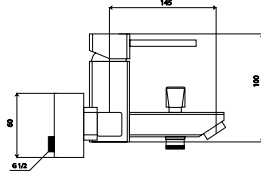

**Mix Banyo Bataryası**

- ÜRÜNÜMÜZ MS58/MS63 ORANINDA ALÇAK BASINÇ PİRİNÇ KÜLÇEDEN ÜRETİLMİŞTİR.
- YÜZEY KAPLAMASI 0,12 İLE 0,16 MİKRON KROM KAPLAMADIR.
- ÇIKIŞ UCU UZUNLUĞU 200 mm'DİR.
- 40 BAR BASINCA DAYANIKLI SERAMİK KARTUŞ KULLANILMAKTADIR.
- PERLATÖRÜN SU AKIŞ DEBİSİ DAKİKADA 19 İLE 23 lt ARASINDADIR.
- YÖNLENDİRİCİ TAKIMI MS58 PİRİNÇTEN ÜRETİLMİŞTİR.
- TESİSAT BAĞLANTILARI G ½' DİR.
- EL DUŞU BAĞLANTISI G ½' DİR.

**Mix Bathroom Faucet**

- OUR PRODUCT IS MADE OF MS58/MS63 BRASS LOW PRESSURE INGOTS
- SURFACE COATING IS 0,16mm CHROME COATING
- OUTPUT LENGTH 200mm
- 40 BAR PRESSURE RESISTANT CERAMIC CARTRIDGE USED
- WATER FLOW IS BETWEEN 19 AND 23 PER MINUTE
- THE ROYTER TOOLS WAS MADE BRASS'S
- INSTALLATION CONNECTIONS ARE G ½
- HAND SHOWER CONNECTIONS ARE G ½

12 | 4.350,00 ₺  
Code: 41 2010 0629

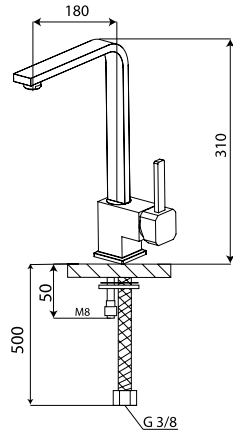

**Mix Kuğu Mutfak Bataryası**

- ÜRÜNÜMÜZ MS58 PİRİNÇ MALZEMEDEN ÜRETİLMİŞTİR.
- YÜZEY KAPLAMASI 0,12 İLE 0,16 MİKRON KROM KAPLAMADIR.
- ÇIKIŞ UCU UZUNLUĞU 185 mm'DİR.
- ÇIKIŞ UCU YÜKSEKLİĞİ 340 mm'DİR.
- ÖZEL ÜRETİM PASLANMAZ BORU.
- 360 DERECE DÖNER BORULUDUR.
- 40 BAR BASINCA DAYANIKLI SERAMİK KARTUŞ KULLANILMAKTADIR.
- PERLATÖRÜN SU AKIŞ DEBİSİ DAKİKADA 12 İLE 18 lt ARASINDADIR.
- 3/8 M-10 40 BAR BASINCA DAYANIKLI ÇELİK ÖRGÜLÜ FLEX KULLANILMIŞTIR.

**Mix Kitchen Faucet**

- OUR PRODUCT IS MADE OF MS58 BRASS
- SURFACE COATING IS 0,16mm CHROME COATING
- OUTPUT LENGTH 185mm
- OUTPUT END PIPE HEIGHT IS 340mm
- SPECIAL PRODUCTION STAINLESS PIPE
- 360 ROTARY PIPE
- 40 BAR PRESSURE RESISTANT CERAMIC CARTRIDGE USED
- WATER FLOW IS BETWEEN 13 AND 18 PER MINUTE
- G 3/8 M-10 40 BAR PRESSURE RESISTANT STEEL BRAIDED FLEX USED

12 | 2.690,00 ₺  
Code: 41 2010 0630

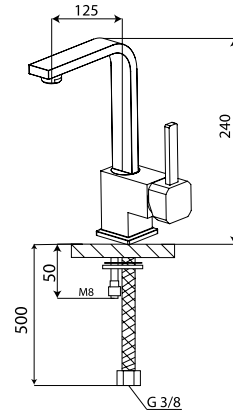

**Mix Kuğu Lavabo Bataryası**

- ÜRÜNÜMÜZ MS58 PİRİNÇ MALZEMEDEN ÜRETİLMİŞTİR.
- YÜZEY KAPLAMASI 0,12 İLE 0,16 MİKRON KROM KAPLAMADIR.
- ÇIKIŞ UCU UZUNLUĞU 135 mm'DİR.
- ÇIKIŞ UCU YÜKSEKLİĞİ 270 mm'DİR.
- ÖZEL ÜRETİM PASLANMAZ BORU.
- 360 DERECE DÖNER BORULUDUR.
- 40 BAR BASINCA DAYANIKLI SERAMİK KARTUŞ KULLANILMAKTADIR.
- PERLATÖRÜN SU AKIŞ DEBİSİ DAKİKADA 12 İLE 18 lt ARASINDADIR.
- 3/8 M-10 40 BAR BASINCA DAYANIKLI ÇELİK ÖRGÜLÜ FLEX KULLANILMIŞTIR.

**Mix Basin Faucet**

- OUR PRODUCT IS MADE OF MS58 BRASS
- SURFACE COATING IS 0,16mm CHROME COATING
- OUTPUT LENGTH 135mm
- OUTPUT END PIPE HEIGHT IS 270mm
- SPECIAL PRODUCTION STAINLESS PIPE
- 360 ROTARY PIPE
- 40 BAR PRESSURE RESISTANT CERAMIC CARTRIDGE USED
- WATER FLOW IS BETWEEN 13 AND 18 PER MINUTE
- G 3/8 M-10 40 BAR PRESSURE RESISTANT STEEL BRAIDED FLEX USED

12 | 2.690,00 ₺  
Code: 41 2010 0631

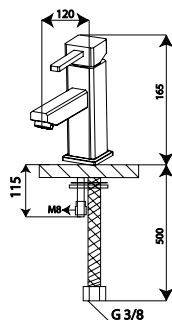

**Mix Sabit Lavabo Bataryası**

- ÜRÜNÜMÜZ MS58 PİRİNÇ MALZEMEDEN ÜRETİLMİŞTİR.
- YÜZEY KAPLAMASI 0,12 İLE 0,16 MİKRON KROM KAPLAMADIR.
- ÇIKIŞ UCU UZUNLUĞU 120 mm'DİR.
- ÜRÜN YÜKSEKLİĞİ 165 mm'DİR.
- 40 BAR BASINCA DAYANIKLI SERAMİK KARTUŞ KULLANILMAKTADIR.
- PERLATÖRÜN SU AKIŞ DEBİSİ DAKİKADA 12 İLE 18 lt ARASINDADIR.
- 3/8 M-10 40 BAR BASINCA DAYANIKLI ÇELİK ÖRGÜLÜ FLEX KULLANILMIŞTIR.

**Mix Basin Faucet**

- OUR PRODUCT IS MADE OF MS58 BRASS
- SURFACE COATING IS 0,16mm CHROME COATING
- OUTPUT LENGTH 120mm
- PRODUCT HEIGHT 165mm
- 40 BAR PRESSURE RESISTANT CERAMIC CARTRIDGE USED
- WATER FLOW IS BETWEEN 13 AND 18 PER MINUTE
- G 3/8 M-10 40 BAR PRESSURE RESISTANT STEEL BRAIDED FLEX USED

12 | 2.990,00 ₺  
Code: 41 2010 0632



**Mix Banyo Bataryası**

- ÜRÜNÜMÜZ MS58/MS63 ORANINDA ALÇAK BASINÇ PİRİNÇ KÜLÇEDEN ÜRETİLMİŞTİR.
- YÜZEY KAPLAMASI 0,12 İLE 0,16 MİKRON KROM KAPLAMADIR.
- ÇIKIŞ UCU UZUNLUĞU 200 mm'DİR.
- 40 BAR BASINCA DAYANIKLI SERAMİK KARTUŞ KULLANILMAKTADIR.
- PERLATÖRÜN SU AKIŞ DEBİSİ DAKİKADA19 İLE 23 lt ARASINDADIR.
- YÖNLENDİRİCİ TAKIMI MS58 PİRİNÇTEN ÜRETİLMİŞTİR.
- TESİSAT BAĞLANTILARI G ½' DİR.
- EL DUŞU BAĞLANTISI G ½' DİR.

**Mix Bathroom Faucet**

- OUR PRODUCT IS MADE OF MS58/MS63 BRASS LOW PRESSURE INGOTS
- SURFACE COATING IS 0,16mm CHROME COATING
- OUTPUT LENGTH 200mm
- 40 BAR PRESSURE RESISTANT CERAMIC CARTRIDGE USED
- WATER FLOW IS BETWEEN 19 AND 23 PER MINUTE
- THE ROYTER TOOLS WAS MADE BRASS'S
- INSTALLATION CONNECTIONS ARE G ½
- HAND SHOWER CONNECTIONS ARE G ½

12 | 4.350,00 ₺  
Code: 41 2010 0625

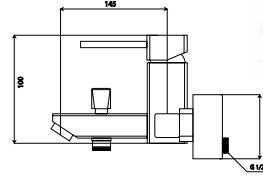
**Mix Kuğu Mutfak Bataryası**

- ÜRÜNÜMÜZ MS58 PİRİNÇ MALZEMEDEN ÜRETİLMİŞTİR.
- YÜZEY KAPLAMASI 0,12 İLE 0,16 MİKRON KROM KAPLAMADIR.
- ÇIKIŞ UCU UZUNLUĞU 185 mm'DİR.
- ÇIKIŞ UCU YÜKSEKLİĞİ 340 mm'DİR.
- ÖZEL ÜRETİM PASLANMAZ BORU.
- 360 DERECE DÖNER BORULUDUR.
- 40 BAR BASINCA DAYANIKLI SERAMİK KARTUŞ KULLANILMAKTADIR.
- PERLATÖRÜN SU AKIŞ DEBİSİ DAKİKADA12 İLE 18 lt ARASINDADIR.
- 3/8 M-10 40 BAR BASINCA DAYANIKLI ÇELİK ÖRGÜLÜ FLEX KULLANILMIŞTIR.

**Mix Kitchen Faucet**

- OUR PRODUCT IS MADE OF MS58 BRASS
- SURFACE COATING IS 0,16mm CHROME COATING
- OUTPUT LENGTH 185mm
- OUTPUT END PIPE HEIGHT IS 340mm
- SPECIAL PRODUCTION STAINLESS PIPE
- 360 ROTARY PIPE
- 40 BAR PRESSURE RESISTANT CERAMIC CARTRIDGE USED
- WATER FLOW IS BETWEEN 13 AND 18 PER MINUTE
- G 3/8 M-10 40 BAR PRESSURE RESISTANT STEEL BRAIDED FLEX USED

12 | 2.690,00 ₺  
Code: 41 2010 0626

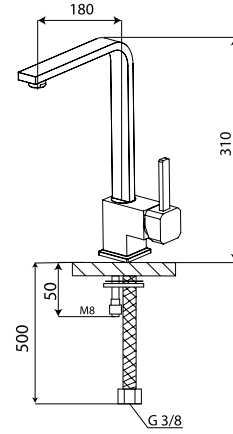
**Mix Kuğu Lavabo Bataryası**

- ÜRÜNÜMÜZ MS58 PİRİNÇ MALZEMEDEN ÜRETİLMİŞTİR.
- YÜZEY KAPLAMASI 0,12 İLE 0,16 MİKRON KROM KAPLAMADIR.
- ÇIKIŞ UCU UZUNLUĞU 135 mm'DİR.
- ÇIKIŞ UCU YÜKSEKLİĞİ 270 mm'DİR.
- ÖZEL ÜRETİM PASLANMAZ BORU.
- 360 DERECE DÖNER BORULUDUR.
- 40 BAR BASINCA DAYANIKLI SERAMİK KARTUŞ KULLANILMAKTADIR.
- PERLATÖRÜN SU AKIŞ DEBİSİ DAKİKADA12 İLE 18 lt ARASINDADIR.
- 3/8 M-10 40 BAR BASINCA DAYANIKLI ÇELİK ÖRGÜLÜ FLEX KULLANILMIŞTIR.

**Mix Basin Faucet**

- OUR PRODUCT IS MADE OF MS58 BRASS
- SURFACE COATING IS 0,16mm CHROME COATING
- OUTPUT LENGTH 135mm
- OUTPUT END PIPE HEIGHT IS 270mm
- SPECIAL PRODUCTION STAINLESS PIPE
- 360 ROTARY PIPE
- 40 BAR PRESSURE RESISTANT CERAMIC CARTRIDGE USED
- WATER FLOW IS BETWEEN 13 AND 18 PER MINUTE
- G 3/8 M-10 40 BAR PRESSURE RESISTANT STEEL BRAIDED FLEX USED

12 | 2.690,00 ₺  
Code: 41 2010 0627

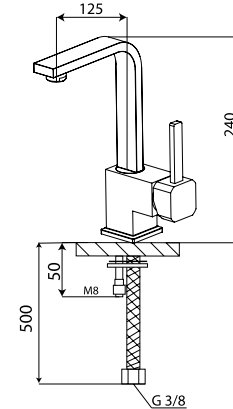
**Mix Sabit Lavabo Bataryası**

- ÜRÜNÜMÜZ MS58 PİRİNÇ MALZEMEDEN ÜRETİLMİŞTİR.
- YÜZEY KAPLAMASI 0,12 İLE 0,16 MİKRON KROM KAPLAMADIR.
- ÇIKIŞ UCU UZUNLUĞU 120 mm'DİR.
- ÜRÜN YÜKSEKLİĞİ 165 mm'DİR.
- 40 BAR BASINCA DAYANIKLI SERAMİK KARTUŞ KULLANILMAKTADIR.
- PERLATÖRÜN SU AKIŞ DEBİSİ DAKİKADA12 İLE 18 lt ARASINDADIR.
- 3/8 M-10 40 BAR BASINCA DAYANIKLI ÇELİK ÖRGÜLÜ FLEX KULLANILMIŞTIR.

**Mix Basin Faucet**

- OUR PRODUCT IS MADE OF MS58 BRASS
- SURFACE COATING IS 0,16mm CHROME COATING
- OUTPUT LENGTH 120mm
- PRODUCT HEIGHT 165mm
- 40 BAR PRESSURE RESISTANT CERAMIC CARTRIDGE USED
- WATER FLOW IS BETWEEN 13 AND 18 PER MINUTE
- G 3/8 M-10 40 BAR PRESSURE RESISTANT STEEL BRAIDED FLEX USED

12 | 2.990,00 ₺  
Code: 41 2010 0628

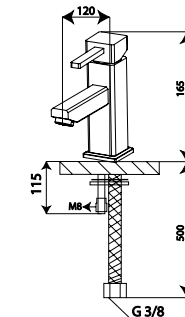

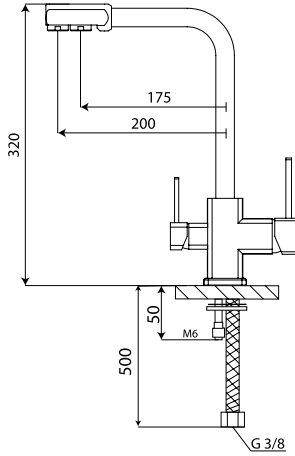

**Krom**  
Code: 41 2010 0616

8 | 4.450,00 ₺

### Mix Kuğu Çift Çıkışlı Temiz Su Mutfak Bataryası

- ÜRÜNÜMÜZ MS58 PİRİNÇ MALZEMEDEN ÜRETİLMİŞTİR.
- YÜZEY KAPLAMASI 0,12 İLE 0,16 MİKRON KROM KAPLAMADIR.
- YÜZEY KAPLAMASI ÖZEL ALTIN BOYADIR.
- YÜZEY KAPLAMASI PULVER 916 BOYADIR.
- ÇIKIŞ UCU UZUNLUĞU 175 mm'DİR.
- 2. ÇIKIŞ UCU UZUNLUĞU 210 mm'DİR.
- ÇIKIŞ UCU YÜKSEKLİĞİ 330 mm'DİR.
- SU AKIŞ BORUSU ÇAPI 22mm, SU AKIŞ BORUSU MS63 PİRİNÇTİR.
- 360 DERECE DÖNER BORULUDUR.
- 40 BAR BASINCA DAYANIKLI SERAMİK KARTUŞ KULLANILMAKTADIR.
- PERLATÖRÜN SU AKIŞ DEBİSİ DAKİKADA 12 İLE 18 lt ARASINDADIR.
- 3/8 M-10 40 BAR BASINCA DAYANIKLI ÇELİK ÖRGÜLÜ FLEX KULLANILMIŞTIR.

### Mix Clean Water Kitchen Faucet

- OUR PRODUCT IS MADE OF MS58 BRASS
- SURFACE COATING IS 0,16mm CHROME COATING
- SURFACE COATING IS SPECIAL GOLD PAINT.
- SURFACE COATING IS PAINTED 916.
- OUTPUT LENGTH 175mm
- SECOND OUTPUT LENGTH 210mm
- OUTPUT END PIPE HEIGHT IS 330mm
- THE DIAMETER FO THE PIPE IS 22, THE WATER FLOW PIPE MS63 IS BRASS
- 360 ROTARY PIPE
- 40 BAR PRESSURE RESISTANT CERAMIC CARTRIDGE USED
- WATER FLOW IS BETWEEN 13 AND 18 PER MINUTE
- G 3/8 M-10 40 BAR PRESSURE RESISTANT STEEL BRAIDED FLEX USED

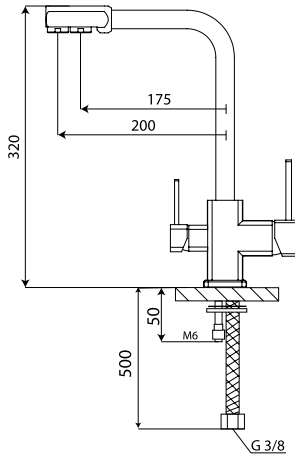

**Mat Siyah**  
Code: 41 2010 0618

4 | 4.900,00 ₺

### Mix Kuğu Çift Çıkışlı Temiz Su Mutfak Bataryası

- ÜRÜNÜMÜZ MS58 PİRİNÇ MALZEMEDEN ÜRETİLMİŞTİR.
- YÜZEY KAPLAMASI 0,12 İLE 0,16 MİKRON KROM KAPLAMADIR.
- YÜZEY KAPLAMASI ÖZEL ALTIN BOYADIR.
- YÜZEY KAPLAMASI PULVER 916 BOYADIR.
- ÇIKIŞ UCU UZUNLUĞU 175 mm'DİR.
- 2. ÇIKIŞ UCU UZUNLUĞU 210 mm'DİR.
- ÇIKIŞ UCU YÜKSEKLİĞİ 330 mm'DİR.
- SU AKIŞ BORUSU ÇAPI 22mm, SU AKIŞ BORUSU MS63 PİRİNÇTİR.
- 360 DERECE DÖNER BORULUDUR.
- 40 BAR BASINCA DAYANIKLI SERAMİK KARTUŞ KULLANILMAKTADIR.
- PERLATÖRÜN SU AKIŞ DEBİSİ DAKİKADA 12 İLE 18 lt ARASINDADIR.
- 3/8 M-10 40 BAR BASINCA DAYANIKLI ÇELİK ÖRGÜLÜ FLEX KULLANILMIŞTIR.

### Mix Clean Water Kitchen Faucet

- OUR PRODUCT IS MADE OF MS58 BRASS
- SURFACE COATING IS 0,16mm CHROME COATING
- SURFACE COATING IS SPECIAL GOLD PAINT.
- SURFACE COATING IS PAINTED 916.
- OUTPUT LENGTH 175mm
- SECOND OUTPUT LENGTH 210mm
- OUTPUT END PIPE HEIGHT IS 330mm
- THE DIAMETER FO THE PIPE IS 22, THE WATER FLOW PIPE MS63 IS BRASS
- 360 ROTARY PIPE
- 40 BAR PRESSURE RESISTANT CERAMIC CARTRIDGE USED
- WATER FLOW IS BETWEEN 13 AND 18 PER MINUTE
- G 3/8 M-10 40 BAR PRESSURE RESISTANT STEEL BRAIDED FLEX USED

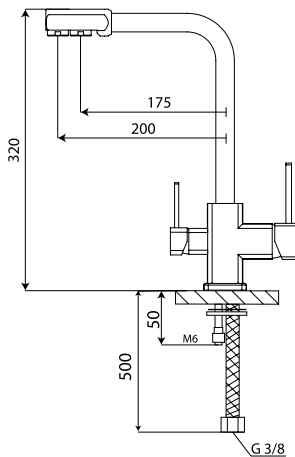

**Altın**  
Code: 41 2010 0619

4 | 5.750,00 ₺

### Mix Kuğu Çift Çıkışlı Temiz Su Mutfak Bataryası

- ÜRÜNÜMÜZ MS58 PİRİNÇ MALZEMEDEN ÜRETİLMİŞTİR.
- YÜZEY KAPLAMASI 0,12 İLE 0,16 MİKRON KROM KAPLAMADIR.
- YÜZEY KAPLAMASI ÖZEL ALTIN BOYADIR.
- YÜZEY KAPLAMASI PULVER 916 BOYADIR.
- ÇIKIŞ UCU UZUNLUĞU 175 mm'DİR.
- 2. ÇIKIŞ UCU UZUNLUĞU 210 mm'DİR.
- ÇIKIŞ UCU YÜKSEKLİĞİ 330 mm'DİR.
- SU AKIŞ BORUSU ÇAPI 22mm, SU AKIŞ BORUSU MS63 PİRİNÇTİR.
- 360 DERECE DÖNER BORULUDUR.
- 40 BAR BASINCA DAYANIKLI SERAMİK KARTUŞ KULLANILMAKTADIR.
- PERLATÖRÜN SU AKIŞ DEBİSİ DAKİKADA 12 İLE 18 lt ARASINDADIR.
- 3/8 M-10 40 BAR BASINCA DAYANIKLI ÇELİK ÖRGÜLÜ FLEX KULLANILMIŞTIR.

### Mix Clean Water Kitchen Faucet

- OUR PRODUCT IS MADE OF MS58 BRASS
- SURFACE COATING IS 0,16mm CHROME COATING
- SURFACE COATING IS SPECIAL GOLD PAINT.
- SURFACE COATING IS PAINTED 916.
- OUTPUT LENGTH 175mm
- SECOND OUTPUT LENGTH 210mm
- OUTPUT END PIPE HEIGHT IS 330mm
- THE DIAMETER FO THE PIPE IS 22, THE WATER FLOW PIPE MS63 IS BRASS
- 360 ROTARY PIPE
- 40 BAR PRESSURE RESISTANT CERAMIC CARTRIDGE USED
- WATER FLOW IS BETWEEN 13 AND 18 PER MINUTE
- G 3/8 M-10 40 BAR PRESSURE RESISTANT STEEL BRAIDED FLEX USED

# SERENA KARE ÇİFT ÇIKIŞLI TEMİZ SU MUTFAK BATARYASI



www.aceser.com.tr

## Mix Kuğu Çift Çıkışlı Temiz Su Mutfak Bataryası

- ÜRÜNÜMÜZ MS58 PİRİNÇ MALZEMEDEN ÜRETİLMİŞTİR.
- YÜZEY KAPLAMASI 0,12 İLE 0,16 MİKRON KROM KAPLAMADIR.
- YÜZEY KAPLAMASI ÖZEL ALTIN BOYADIR.
- YÜZEY KAPLAMASI PULVER 916 BOYADIR.
- ÇIKIŞ UCU UZUNLUĞU 175 mm'DİR.
- 2. ÇIKIŞ UCU UZUNLUĞU 210 mm'DİR.
- ÇIKIŞ UCU YÜKSEKLİĞİ 330 mm'DİR.
- SU AKIŞ BORUSU ÇAPU 22mm, SU AKIŞ BORUSU MS63 PİRİNÇTİR.
- 360 DERECE DÖNER BORULUDUR.
- 40 BAR BASINCA DAYANIKLI SERAMİK KARTUŞ KULLANILMAKTADIR.
- PERLATÖRÜN SU AKIŞ DEBİSİ DAKİKADA12 İLE 18 lt ARASINDADIR.
- 3/8 M-10 40 BAR BASINCA DAYANIKLI ÇELİK ÖRGÜLÜ FLEX KULLANILMIŞTIR.

## Mix Clean Water Kitchen Faucet

- OUR PRODUCT IS MADE OF MS58 BRASS
- SURFACE COATING IS 0,16mm CHROME COATING
- SURFACE COATING IS SPECIAL GOLD PAINT.
- SURFACE COATING IS PAINTED 916.
- OUTPUT LENGTH 175mm
- SECOND OUTPUT LENGTH 210mm
- OUTPUT END PIPE HEIGHT IS 330mm
- THE DIAMETER FO THE PIPE IS 22, THE WATER FLOW PIPE MS63 IS BRASS
- 360 ROTARY PIPE
- 40 BAR PRESSURE RESISTANT CERAMIC CARTRIDGE USED
- WATER FLOW IS BETWEEN 13 AND 18 PER MINUTE
- G 3/8 M-10 40 BAR PRESSURE RESISTANT STEEL BRAIDED FLEX USED

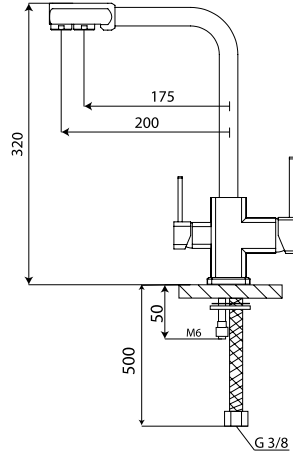

**Eskitme**  
Code: 41 2010 0620



4

5.750,00 ₺

## Mix Kuğu Çift Çıkışlı Temiz Su Mutfak Bataryası

- ÜRÜNÜMÜZ MS58 PİRİNÇ MALZEMEDEN ÜRETİLMİŞTİR.
- YÜZEY KAPLAMASI 0,12 İLE 0,16 MİKRON KROM KAPLAMADIR.
- YÜZEY KAPLAMASI ÖZEL ALTIN BOYADIR.
- YÜZEY KAPLAMASI PULVER 916 BOYADIR.
- ÇIKIŞ UCU UZUNLUĞU 175 mm'DİR.
- 2. ÇIKIŞ UCU UZUNLUĞU 210 mm'DİR.
- ÇIKIŞ UCU YÜKSEKLİĞİ 330 mm'DİR.
- SU AKIŞ BORUSU ÇAPU 22mm, SU AKIŞ BORUSU MS63 PİRİNÇTİR.
- 360 DERECE DÖNER BORULUDUR.
- 40 BAR BASINCA DAYANIKLI SERAMİK KARTUŞ KULLANILMAKTADIR.
- PERLATÖRÜN SU AKIŞ DEBİSİ DAKİKADA12 İLE 18 lt ARASINDADIR.
- 3/8 M-10 40 BAR BASINCA DAYANIKLI ÇELİK ÖRGÜLÜ FLEX KULLANILMIŞTIR.

## Mix Clean Water Kitchen Faucet

- OUR PRODUCT IS MADE OF MS58 BRASS
- SURFACE COATING IS 0,16mm CHROME COATING
- SURFACE COATING IS SPECIAL GOLD PAINT.
- SURFACE COATING IS PAINTED 916.
- OUTPUT LENGTH 175mm
- SECOND OUTPUT LENGTH 210mm
- OUTPUT END PIPE HEIGHT IS 330mm
- THE DIAMETER FO THE PIPE IS 22, THE WATER FLOW PIPE MS63 IS BRASS
- 360 ROTARY PIPE
- 40 BAR PRESSURE RESISTANT CERAMIC CARTRIDGE USED
- WATER FLOW IS BETWEEN 13 AND 18 PER MINUTE
- G 3/8 M-10 40 BAR PRESSURE RESISTANT STEEL BRAIDED FLEX USED

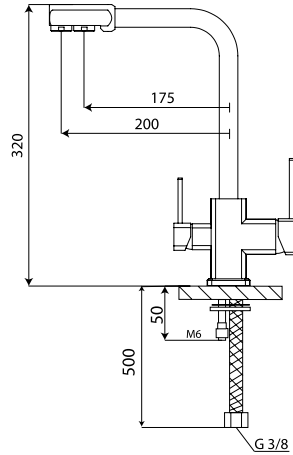

**Beyaz**  
Code: 41 2010 0617



4

4.900,00 ₺

## Mix Kuğu Çift Çıkışlı Temiz Su Mutfak Bataryası

- ÜRÜNÜMÜZ MS58 PİRİNÇ MALZEMEDEN ÜRETİLMİŞTİR.
- YÜZEY KAPLAMASI 0,12 İLE 0,16 MİKRON KROM KAPLAMADIR.
- YÜZEY KAPLAMASI ÖZEL ALTIN BOYADIR.
- YÜZEY KAPLAMASI PULVER 916 BOYADIR.
- ÇIKIŞ UCU UZUNLUĞU 175 mm'DİR.
- 2. ÇIKIŞ UCU UZUNLUĞU 210 mm'DİR.
- ÇIKIŞ UCU YÜKSEKLİĞİ 330 mm'DİR.
- SU AKIŞ BORUSU ÇAPU 22mm, SU AKIŞ BORUSU MS63 PİRİNÇTİR.
- 360 DERECE DÖNER BORULUDUR.
- 40 BAR BASINCA DAYANIKLI SERAMİK KARTUŞ KULLANILMAKTADIR.
- PERLATÖRÜN SU AKIŞ DEBİSİ DAKİKADA12 İLE 18 lt ARASINDADIR.
- 3/8 M-10 40 BAR BASINCA DAYANIKLI ÇELİK ÖRGÜLÜ FLEX KULLANILMIŞTIR.

## Mix Clean Water Kitchen Faucet

- OUR PRODUCT IS MADE OF MS58 BRASS
- SURFACE COATING IS 0,16mm CHROME COATING
- SURFACE COATING IS SPECIAL GOLD PAINT.
- SURFACE COATING IS PAINTED 916.
- OUTPUT LENGTH 175mm
- SECOND OUTPUT LENGTH 210mm
- OUTPUT END PIPE HEIGHT IS 330mm
- THE DIAMETER FO THE PIPE IS 22, THE WATER FLOW PIPE MS63 IS BRASS
- 360 ROTARY PIPE
- 40 BAR PRESSURE RESISTANT CERAMIC CARTRIDGE USED
- WATER FLOW IS BETWEEN 13 AND 18 PER MINUTE
- G 3/8 M-10 40 BAR PRESSURE RESISTANT STEEL BRAIDED FLEX USED



**Ross**  
Code: 41 2010 0622



4

5.750,00 ₺

**Saten**  
Code: 41 2010 0621



4

5.750,00 ₺

**İnci Siyah**  
Code: 41 2010 0623



4

5.750,00 ₺



**Altın**  
Code: 45 2010 2155

4 | 4.990,00 ₺



**Saten**  
Code: 45 2010 2159

4 | 4.990,00 ₺



**İnci Siyah**  
Code: 45 2010 2158

4 | 4.990,00 ₺



**Ross**  
Code: 45 2010 2166

4 | 4.990,00 ₺



**Eskitme**  
Code: 45 2010 2165

4 | 4.990,00 ₺



**Beyaz**  
Code: 45 2010 2157

4 | 4.350,00 ₺



**Mat Siyah**  
Code: 45 2010 2156

4 | 4.350,00 ₺

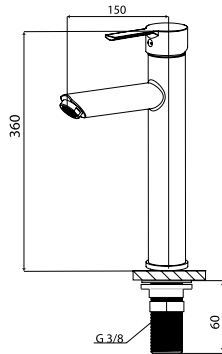

#### Mix Çanak Lavabo Bataryası

- ÜRÜNÜMÜZ MS58/MS63 ORANINDA ALÇAK BASINÇ PİRİNÇ KÜLÇEDEN ÜRETİLMİŞTİR.
- YÜZEY KAPLAMASI 0,12 İLE 0,16 MİKRON KROM KAPLAMADIR.
- YÜZEY KAPLAMASI ÖZEL ALTIN BOYADIR.
- YÜZEY KAPLAMASI PULVER 916 BOYADIR.
- ÇIKIŞ UCU UZUNLUĞU 118 mm'DİR.
- ÜRÜN YÜKSEKLİĞİ 165 mm'DİR.
- 40 BAR BASINCA DAYANIKLI SERAMİK KARTUŞ KULLANILMAKTADIR.
- PERLATÖRÜN SU AKIŞ DEBİSİ DAKİKADA 19 İLE 23 lt ARASINDADIR.
- 3/8 M-10 40 BAR BASINCA DAYANIKLI ÇELİK ÖRGÜLÜ FLEX KULLANILMIŞTIR.

#### Mix Basın Faucet

- OUR PRODUCT IS MADE OF MS58/MS63 BRASS LOW PRESSURE INGOTS
- SURFACE COATING IS 0,16mm CHROME COATING
- SURFACE COATING IS SPECIAL GOLD PAINT.
- SURFACE COATING IS PAINTED 916.
- OUTPUT LENGTH 118 mm
- PRODUCT HEIGHT 165 mm
- 40 BAR PRESSURE RESISTANT CERAMIC CARTRIDGE USED
- WATER FLOW IS BETWEEN 19 AND 23 PER MINUTE
- G 3/8 M-10 40 BAR PRESSURE RESISTANT STEEL BRAIDED FLEX USED

# SERENA SERİSİ ÇANAK LAVABO BATARYASI



www.aceser.com.tr



**Altın**  
Code: 41 2010 0613

4 | 5.990,00 ₺



**Saten**  
Code: 41 2010 0670

4 | 5.990,00 ₺



**İnci Siyah**  
Code: 41 2010 0611

4 | 5.990,00 ₺



**Ross**  
Code: 41 2010 0672

4 | 5.990,00 ₺



**Eskitme**  
Code: 41 2010 0671

4 | 5.990,00 ₺



**Beyaz**  
Code: 41 2010 0615

4 | 5.550,00 ₺

## Mix Çanak Lavabo Bataryası

- ÜRÜNÜMÜZ MS58/MS63 ORANINDA ALÇAK BASINÇ PİRİNÇ KÜLÇEDEN ÜRETİLMİŞTİR.
- YÜZEY KAPLAMASI 0,12 İLE 0,16 MİKRON KROM KAPLAMADIR.
- YÜZEY KAPLAMASI ÖZEL ALTIN BOYADIR.
- YÜZEY KAPLAMASI PULVER 916 BOYADIR.
- ÇIKIŞ UCU UZUNLUĞU 118 mm'DİR.
- ÜRÜN YÜKSEKLİĞİ 165 mm'DİR.
- 40 BAR BASINCA DAYANIKLI SERAMİK KARTUŞ KULLANILMAKTADIR.
- PERLATÖRÜN SU AKIŞ DEBİSİ DAKİKADA 19 İLE 23 lt ARASINDADIR.
- 3/8 M-10 40 BAR BASINCA DAYANIKLI ÇELİK ÖRGÜLÜ FLEX KULLANILMIŞTIR.

## Mix Basın Faucet

- OUR PRODUCT IS MADE OF MS58/MS63 BRASS LOW PRESSURE INGOTS
- SURFACE COATING IS 0,16mm CHROME COATING
- SURFACE COATING IS SPECIAL GOLD PAINT.
- SURFACE COATING IS PAINTED 916.
- OUTPUT LENGTH 118 mm
- PRODUCT HEIGHT 165 mm
- 40 BAR PRESSURE RESISTANT CERAMIC CARTRIDGE USED
- WATER FLOW IS BETWEEN 19 AND 23 PER MINUTE
- G 3/8 M-10 40 BAR PRESSURE RESISTANT STEEL BRAIDED FLEX USED

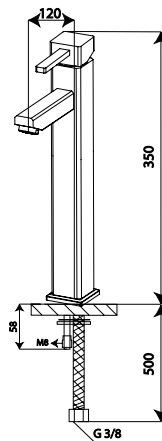

**Mat Siyah**  
Code: 41 2010 0610

4 | 5.550,00 ₺

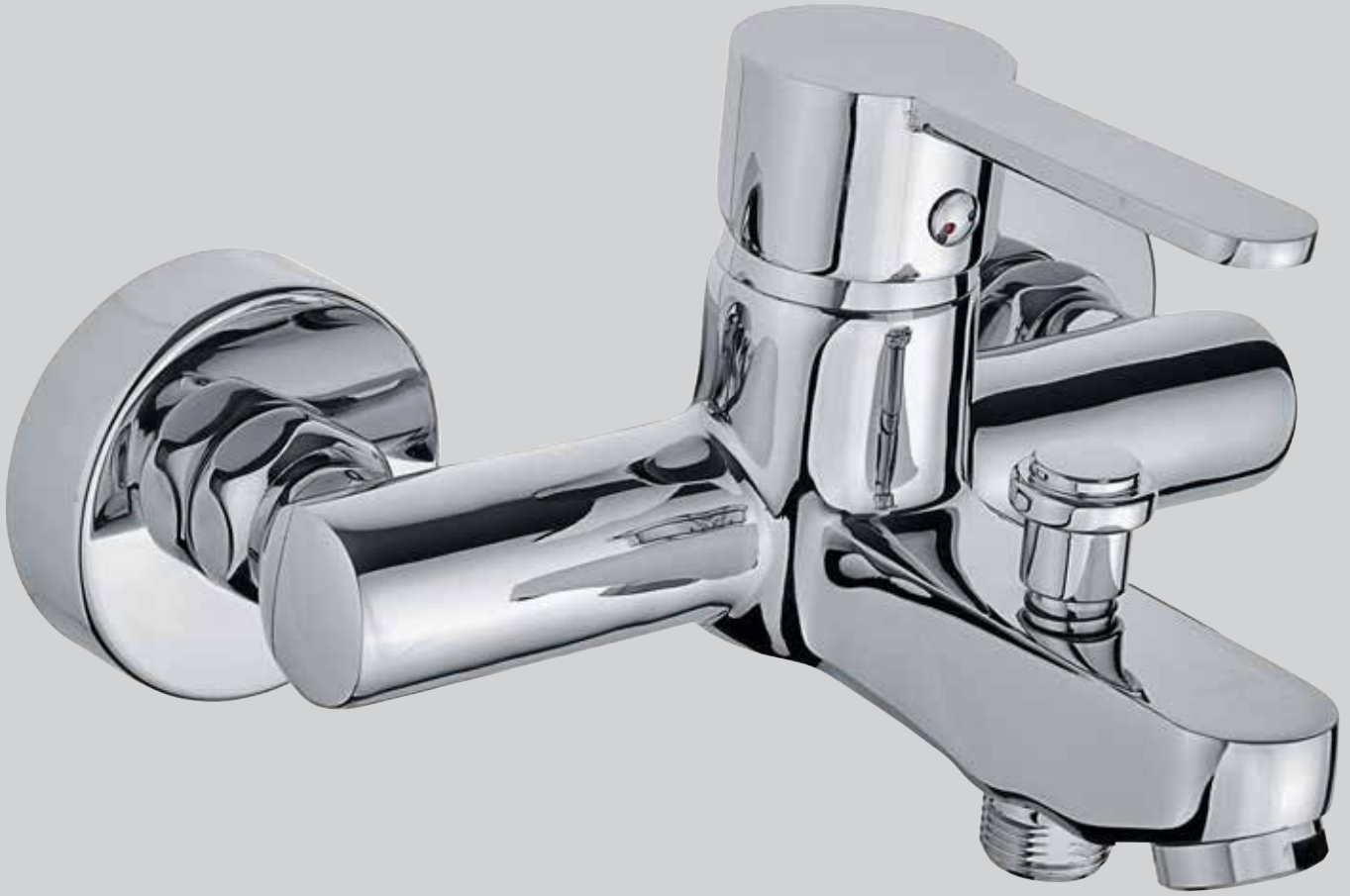

### Mix Banyo Bataryası

- ÜRÜNÜMÜZ MS58/MS63 ORANINDA ALÇAK BASINÇ PİRİNÇ KÜLÇEDEN ÜRETİLMİŞTİR.
- YÜZEY KAPLAMASI 0,12 İLE 0,16 MİKRON KROM KAPLAMADIR.
- ÇIKIŞ UCU UZUNLUĞU 175 mm'DİR.
- 40 BAR BASINCA DAYANIKLI SERAMİK KARTUŞ KULLANILMAKTADIR.
- PERLATÖRÜN SU AKIŞ DEBİSİ DAKİKADA 19 İLE 23 lt ARASINDADIR.
- YÖNLENDİRİCİ TAKIMI MS58 PİRİNÇTEN ÜRETİLMİŞTİR.
- TESİSAT BAĞLANTILARI G ½' DİR.
- EL DUŞU BAĞLANTISI G ½' DİR.

### Mix Bathroom Faucet

- OUR PRODUCT IS MADE OF MS58/MS63 BRASS LOW PRESSURE INGOTS
- SURFACE COATING IS 0,16mm CHROME COATING
- OUTPUT LENGTH 175mm
- 40 BAR PRESSURE RESISTANT CERAMIC CARTRIDGE USED
- WATER FLOW IS BETWEEN 19 AND 23 PER MINUTE
- THE ROYTER TOOLS WAS MADE BRASS'S
- INSTALLATION CONNECTIONS ARE G ½
- HAND SHOWER CONNECTIONS ARE G ½

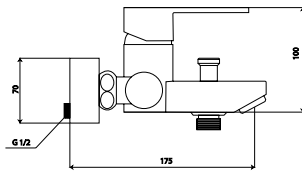

12 | 3.249,00 ₺  
Code: 55 2010 5601

### Mix Duvardan Döner Mutfak Bataryası

- ÜRÜNÜMÜZ MS58/MS63 ORANINDA ALÇAK BASINÇ PİRİNÇ KÜLÇEDEN ÜRETİLMİŞTİR.
- YÜZEY KAPLAMASI 0,16 MİKRON KROM KAPLAMADIR.
- ÇIKIŞ UCU UZUNLUĞU 170 mm'DİR.
- ÇIKIŞ UCU YÜKSEKLİĞİ 180 mm'DİR.
- 40 BAR BASINCA DAYANIKLI SERAMİK KARTUŞ KULLANILMAKTADIR.
- PERLATÖRÜN SU AKIŞ DEBİSİ DAKİKADA 12 İLE 18 lt ARASINDADIR.
- TESİSAT BAĞLANTILARI G ½' DİR.

### Mix Wall Mounted Rotating Kitchen Faucet

- OUR PRODUCT IS MADE OF MS58/MS63 BRASS LOW PRESSURE INGOTS
- SURFACE COATING IS 0,16mm CHROME COATING
- OUTPUT LENGTH 170mm
- OUTPUT END PIPE HEIGHT IS 180mm
- 40 BAR PRESSURE RESISTANT CERAMIC CARTRIDGE USED
- WATER FLOW IS BETWEEN 12 AND 18 PER MINUTE
- INSTALLATION CONNECTIONS ARE G ½

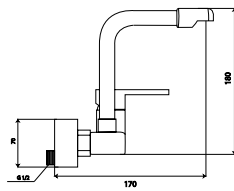

12 | 3.361,00 ₺  
Code: 55 2010 5611

**Mix Kuğu Mutfak Bataryası**

- ÜRÜNÜMÜZ MS58 PİRİNÇ MALZEMEDEN ÜRETİLMİŞTİR.
- YÜZEY KAPLAMASI 0,12 İLE 0,16 MİKRON KROM KAPLAMADIR.
- ÇIKIŞ UCU UZUNLUĞU 185 mm'DİR.
- ÇIKIŞ UCU YÜKSEKLİĞİ 350mm'DİR.
- SU AKIŞ BORUSU ÇAPI 22mm, SU AKIŞ BORUSU MS63 PİRİNÇTİR.
- 360 DERECE DÖNER BORULUDUR.
- 40 BAR BASINCA DAYANIKLI SERAMİK KARTUŞ KULLANILMAKTADIR.
- PERLATÖRÜN SU AKIŞ DEBİSİ DAKİKADA12 İLE 18 lt ARASINDADIR.
- 3/8 M-10 40 BAR BASINCA DAYANIKLI ÇELİK ÖRGÜLÜ FLEX KULLANILMIŞTIR.

**Mix Kitchen Faucet**

- OUR PRODUCT IS MADE OF MS58 BRASS
- SURFACE COATING IS 0,16mm CHROME COATING
- OUTPUT LENGTH 185mm
- OUTPUT END PIPE HEIGHT IS 350mm
- THE DIAMETER FO THE PIPE IS 22, THE WATER FLOW PIPE MS63 IS BRASS
- 360 ROTARY PIPE
- 40 BAR PRESSURE RESISTANT CERAMIC CARTRIDGE USED
- WATER FLOW IS BETWEEN 13 AND 18 PER MINUTE
- G 3/8 M-10 40 BAR PRESSURE RESISTANT STEEL BRAIDED FLEX USED

12 | 2.850,00 ₺  
Code: 55 2010 5602

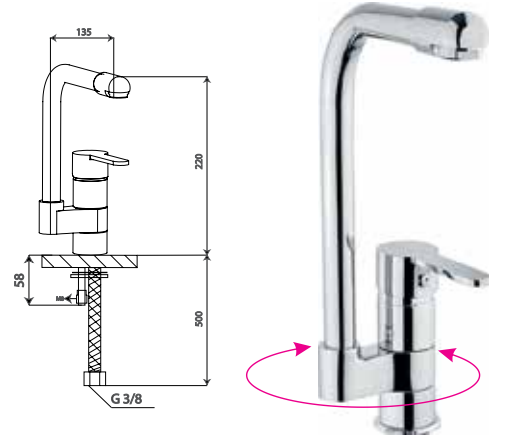
**Mix Kuğu Lavabo Bataryası**

- ÜRÜNÜMÜZ MS58 PİRİNÇ MALZEMEDEN ÜRETİLMİŞTİR.
- YÜZEY KAPLAMASI 0,16 MİKRON KROM KAPLAMADIR.
- ÇIKIŞ UCU UZUNLUĞU 135 mm'DİR.
- ÇIKIŞ UCU YÜKSEKLİĞİ 220 mm'DİR.
- SU AKIŞ BORUSU ÇAPI 22mm, SU AKIŞ BORUSU MS63 PİRİNÇ.
- 360 DERECE DÖNER BORULUDUR.
- 40 BAR BASINCA DAYANIKLI SERAMİK KARTUŞ KULLANILMAKTADIR.
- PERLATÖRÜN SU AKIŞ DEBİSİ DAKİKADA12 İLE 18 lt ARASINDADIR.
- 3/8 M-10 40 BAR BASINCA DAYANIKLI ÇELİK ÖRGÜLÜ FLEX KULLANILMIŞTIR.

**Basin Faucet**

- OUR PRODUCT IS MADE OF MS58 BRASS
- SURFACE COATING IS 0,16mm CHROME COATING
- OUTPUT LENGTH 135mm
- OUTPUT END PIPE HEIGHT IS 220mm
- THE DIAMETER FO THE PIPE IS 22, THE WATER FLOW PIPE MS63 IS BRASS
- 360 ROTARY PIPE
- 40 BAR PRESSURE RESISTANT CERAMIC CARTRIDGE USED
- WATER FLOW IS BETWEEN 13 AND 18 PER MINUTE
- G 3/8 M-10 40 BAR PRESSURE RESISTANT STEEL BRAIDED FLEX USED

12 | 2.650,00 ₺  
Code: 55 2010 5603

**Mix Kuğu Akıllı Mutfak Bataryası**

- ÜRÜNÜMÜZ MS58 PİRİNÇ MALZEMEDEN ÜRETİLMİŞTİR.
- YÜZEY KAPLAMASI 0,12 İLE 0,16 MİKRON KROM KAPLAMADIR.
- ÇIKIŞ UCU UZUNLUĞU 185 mm'DİR.
- ÇIKIŞ UCU YÜKSEKLİĞİ 400 mm'DİR.
- SU AKIŞ BORUSU ÇAPI 22mm, SU AKIŞ BORUSU MS63 PİRİNÇTİR.
- 360 DERECE DÖNER BORULUDUR.
- 40 BAR BASINCA DAYANIKLI SERAMİK KARTUŞ KULLANILMAKTADIR.
- PERLATÖRÜN SU AKIŞ DEBİSİ DAKİKADA12 İLE 18 lt ARASINDADIR.
- 3/8 M-10 40 BAR BASINCA DAYANIKLI ÇELİK ÖRGÜLÜ FLEX KULLANILMIŞTIR.

**Smart Kitchen Faucet**

- OUR PRODUCT IS MADE OF MS58 BRASS
- SURFACE COATING IS 0,16mm CHROME COATING
- OUTPUT LENGTH 185mm
- OUTPUT END PIPE HEIGHT IS 400mm
- THE DIAMETER FO THE PIPE IS 22, THE WATER FLOW PIPE MS63 IS BRASS
- 360 ROTARY PIPE
- 40 BAR PRESSURE RESISTANT CERAMIC CARTRIDGE USED
- WATER FLOW IS BETWEEN 13 AND 18 PER MINUTE
- G 3/8 M-10 40 BAR PRESSURE RESISTANT STEEL BRAIDED FLEX USED

12 | 3.490,00 ₺  
Code: 55 2010 5614

Ürünümüz  
Patentlidir

El Ayarlı  
Su Tasarruflu

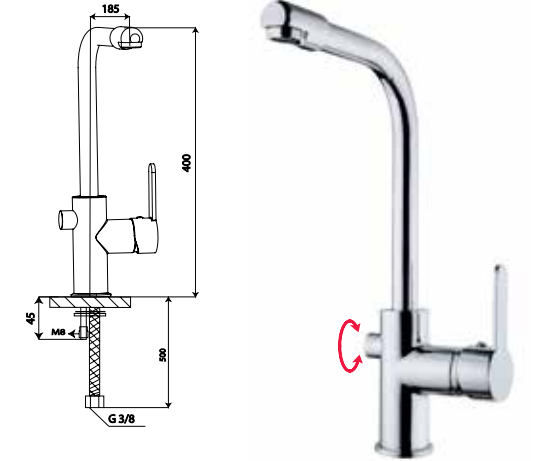
**Mix Kuğu Akıllı Lavabo Bataryası**

- ÜRÜNÜMÜZ MS58 PİRİNÇ MALZEMEDEN ÜRETİLMİŞTİR.
- YÜZEY KAPLAMASI 0,12 İLE 0,16 MİKRON KROM KAPLAMADIR.
- ÇIKIŞ UCU UZUNLUĞU 135 mm'DİR.
- ÇIKIŞ UCU YÜKSEKLİĞİ 270 mm'DİR.
- SU AKIŞ BORUSU ÇAPI 22mm, SU AKIŞ BORUSU MS63 PİRİNÇTİR.
- 360 DERECE DÖNER BORULUDUR.
- 40 BAR BASINCA DAYANIKLI SERAMİK KARTUŞ KULLANILMAKTADIR.
- PERLATÖRÜN SU AKIŞ DEBİSİ DAKİKADA12 İLE 18 lt ARASINDADIR.
- 3/8 M-10 40 BAR BASINCA DAYANIKLI ÇELİK ÖRGÜLÜ FLEX KULLANILMIŞTIR.

**Smart Basin Faucet**

- OUR PRODUCT IS MADE OF MS58 BRASS
- SURFACE COATING IS 0,16mm CHROME COATING
- OUTPUT LENGTH 135mm
- OUTPUT END PIPE HEIGHT IS 270mm
- THE DIAMETER FO THE PIPE IS 22, THE WATER FLOW PIPE MS63 IS BRASS
- 360 ROTARY PIPE
- 40 BAR PRESSURE RESISTANT CERAMIC CARTRIDGE USED
- WATER FLOW IS BETWEEN 13 AND 18 PER MINUTE
- G 3/8 M-10 40 BAR PRESSURE RESISTANT STEEL BRAIDED FLEX USED

12 | 3.390,00 ₺  
Code: 55 2010 5615

Ürünümüz  
Patentlidir

El Ayarlı  
Su Tasarruflu

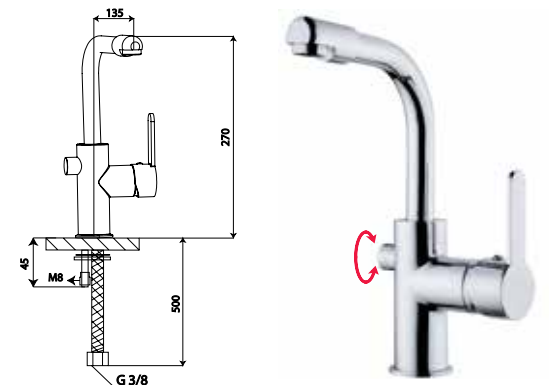





**Mix Cobra Lavabo Bataryası**

- ÜRÜNÜMÜZ MS58/MS63 ORANINDA ALÇAK BASINÇ PİRİNÇ KÜLÇEDEN ÜRETİLMİŞTİR.
- YÜZEY KAPLAMASI 0,12 İLE 0,16 MİKRON KROM KAPLAMADIR.
- ÇIKIŞ UCU UZUNLUĞU 100 mm'DİR.
- ÜRÜN YÜKSEKLİĞİ 205 mm'DİR.
- 40 BAR BASINCA DAYANIKLI SERAMİK KARTUŞ KULLANILMAKTADIR.
- PERLATÖRÜN SU AKIŞ DEBİSİ DAKİKADA19 İLE 23 lt ARASINDADIR.
- 3/8 M-10 40 BAR BASINCA DAYANIKLI ÇELİK ÖRGÜLÜ FLEX KULLANILMIŞTIR.

**Mix Cobra Basın Faucet**

- OUR PRODUCT IS MADE OF MS58/MS63 BRASS LOW PRESSURE INGOTS
- SURFACE COATING IS 0,16mm CHROME COATING
- OUTPUT LENGTH 100 mm
- PRODUCT HEIGHT 205 mm
- 40 BAR PRESSURE RESISTANT CERAMIC CARTRIDGE USED
- WATER FLOW IS BETWEEN 19 AND 23 PER MINUTE
- G 3/8 M-10 40 BAR PRESSURE RESISTANT STEEL BRAIDED FLEX USED

12 | 4.610,00 ₺  
Code: 55 2010 5604

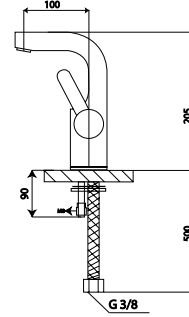
**Mix Çanak Lavabo Bataryası**

- ÜRÜNÜMÜZ MS58/MS63 ORANINDA ALÇAK BASINÇ PİRİNÇ KÜLÇEDEN ÜRETİLMİŞTİR.
- YÜZEY KAPLAMASI 0,12 İLE 0,16 MİKRON KROM KAPLAMADIR.
- ÇIKIŞ UCU UZUNLUĞU 135 mm'DİR.
- ÜRÜN YÜKSEKLİĞİ 385 mm'DİR.
- 40 BAR BASINCA DAYANIKLI SERAMİK KARTUŞ KULLANILMAKTADIR.
- PERLATÖRÜN SU AKIŞ DEBİSİ DAKİKADA19 İLE 23 lt ARASINDADIR.
- 3/8 M-10 40 BAR BASINCA DAYANIKLI ÇELİK ÖRGÜLÜ FLEX KULLANILMIŞTIR.

**Mix High Basın Faucet**

- OUR PRODUCT IS MADE OF MS58/MS63 BRASS LOW PRESSURE INGOTS
- SURFACE COATING IS 0,16mm CHROME COATING
- OUTPUT LENGTH 135 mm
- PRODUCT HEIGHT 385 mm
- 40 BAR PRESSURE RESISTANT CERAMIC CARTRIDGE USED
- WATER FLOW IS BETWEEN 19 AND 23 PER MINUTE
- G 3/8 M-10 40 BAR PRESSURE RESISTANT STEEL BRAIDED FLEX USED

9 | 3.196,00 ₺  
Code: 55 2010 5612

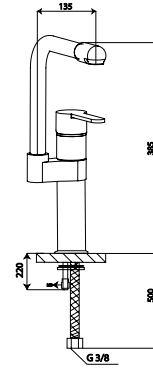
**Mix Lavabo Bataryası**

- ÜRÜNÜMÜZ MS58/MS63 ORANINDA ALÇAK BASINÇ PİRİNÇ KÜLÇEDEN ÜRETİLMİŞTİR.
- YÜZEY KAPLAMASI 0,12 İLE 0,16 MİKRON KROM KAPLAMADIR.
- ÇIKIŞ UCU UZUNLUĞU 105 mm'DİR.
- ÜRÜN YÜKSEKLİĞİ 170 mm'DİR.
- 40 BAR BASINCA DAYANIKLI SERAMİK KARTUŞ KULLANILMAKTADIR.
- PERLATÖRÜN SU AKIŞ DEBİSİ DAKİKADA19 İLE 23 lt ARASINDADIR.
- 3/8 M-10 40 BAR BASINCA DAYANIKLI ÇELİK ÖRGÜLÜ FLEX KULLANILMIŞTIR.

**Mix Basın Faucet**

- OUR PRODUCT IS MADE OF MS58/MS63 BRASS LOW PRESSURE INGOTS
- SURFACE COATING IS 0,16mm CHROME COATING
- OUTPUT LENGTH 105 mm
- PRODUCT HEIGHT 170 mm
- 40 BAR PRESSURE RESISTANT CERAMIC CARTRIDGE USED
- WATER FLOW IS BETWEEN 19 AND 23 PER MINUTE
- G 3/8 M-10 40 BAR PRESSURE RESISTANT STEEL BRAIDED FLEX USED

12 | 2.650,00 ₺  
Code: 55 2010 5619

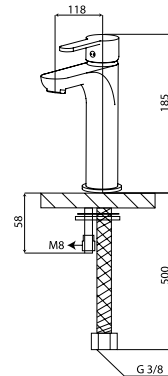

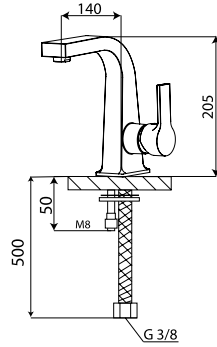
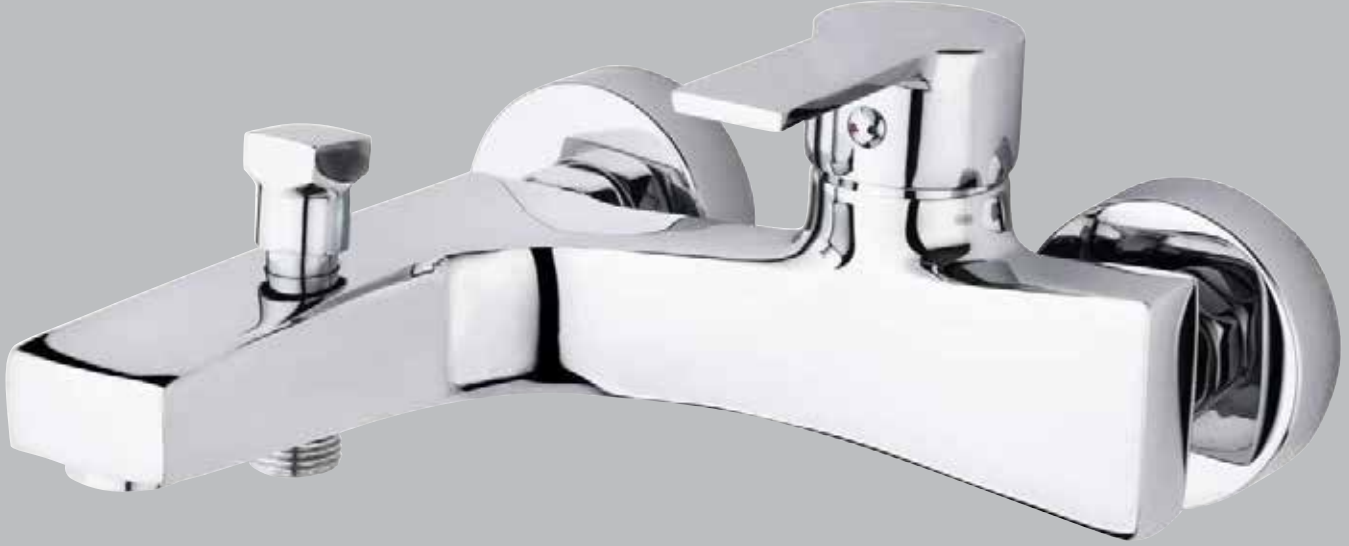

#### Mix Lavabo Bataryası

- ÜRÜNÜMÜZ MS58/MS63 ORANINDA ALÇAK BASINÇ PİRİNÇ KÜLÇEDEN ÜRETİLMİŞTİR.
- YÜZEY KAPLAMASI 0,12 İLE 0,16 MİKRON KROM KAPLAMADIR.
- ÇIKIŞ UCU UZUNLUĞU 120 mm'DİR.
- ÜRÜN YÜKSEKLİĞİ 165 mm'DİR.
- 40 BAR BASINCA DAYANIKLI SERAMİK KARTUŞ KULLANILMAKTADIR.
- PERLATÖRÜN SU AKIŞ DEBİSİ DAKİKADA 19 İLE 23 lt ARASINDADIR.
- 3/8 M-10 40 BAR BASINCA DAYANIKLI ÇELİK ÖRGÜLÜ FLEX KULLANILMIŞTIR.

#### Mix Basın Faucet

- OUR PRODUCT IS MADE OF MS58/MS63 BRASS LOW PRESSURE INGOTS
- SURFACE COATING IS 0,16mm CHROME COATING
- OUTPUT LENGTH 120 mm
- PRODUCT HEIGHT 165 mm
- 40 BAR PRESSURE RESISTANT CERAMIC CARTRIDGE USED
- WATER FLOW IS BETWEEN 19 AND 23 PER MINUTE
- G 3/8 M-10 40 BAR PRESSURE RESISTANT STEEL BRAIDED FLEX USED

12 | 4.350,00₺

Code: 71 2010 0004

#### Mix Aplike Eviye Bataryası

- ÜRÜNÜMÜZ MS58 PİRİNÇ MALZEMEDEN ÜRETİLMİŞTİR.
- YÜZEY KAPLAMASI 0,16 MİKRON KROM KAPLAMADIR.
- ÇIKIŞ UCU UZUNLUĞU 120 mm'DİR.
- ÇIKIŞ UCU YÜKSEKLİĞİ 225 mm'DİR.
- SU AKIŞ BORUSU ÇAP 22, SU AKIŞ BORUSU MS63 PİRİNÇTİR.
- 360 DERECE DÖNER BORULUDUR.
- 40 BAR BASINCA DAYANIKLI SERAMİK KARTUŞ KULLANILMAKTADIR.
- PERLATÖRÜN SU AKIŞ DEBİSİ DAKİKADA 12 İLE 18 lt ARASINDADIR.
- 3/8 M-10 40 BAR BASINCA DAYANIKLI ÇELİK ÖRGÜLÜ FLEX KULLANILMIŞTIR.

#### Applique Kitchen Faucet

- OUR PRODUCT IS MADE OF MS58 BRASS
- SURFACE COATING IS 0,16mm CHROME COATING
- OUTPUT LENGTH 120mm
- OUTPUT END PIPE HEIGHT IS 225mm
- THE DIAMETER FO THE PIPE IS 18, THE WATER FLOW PIPE MS63 IS BRASS
- 360 ROTARY PIPE
- 40 BAR PRESSURE RESISTANT CERAMIC CARTRIDGE USED
- WATER FLOW IS BETWEEN 13 AND 18 PER MINUTE
- G 3/8 M-10 40 BAR PRESSURE RESISTANT STEEL BRAIDED FLEX USED

12 | 4.060,00₺

Code: 71 2010 0005

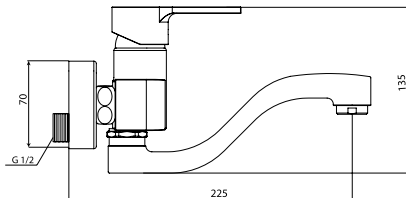

## Mix Banyo Bataryası

- ÜRÜNÜMÜZ MS58/MS63 ORANINDA ALÇAK BASINÇ PİRİNÇ KÜLÇEDEN ÜRETİLMİŞTİR.
- YÜZEY KAPLAMASI 0,12 İLE 0,16 MİKRON KROM KAPLAMADIR.
- ÇIKIŞ UCU UZUNLUĞU 175 mm'DİR.
- 40 BAR BASINCA DAYANIKLI SERAMİK KARTUŞ KULLANILMAKTADIR.
- PERLATÖRÜN SU AKIŞ DEBİSİ DAKİKADA 19 İLE 23 lt ARASINDADIR.
- YÖNLENDİRİCİ TAKIMI MS58 PİRİNÇTEN ÜRETİLMİŞTİR.
- TESİSAT BAĞLANTILARI G ½' DİR.
- EL DUŞU BAĞLANTISI G ½' DİR.



## Mix Bathroom Faucet

- OUR PRODUCT IS MADE OF MS58/MS63 BRASS LOW PRESSURE INGOTS
- SURFACE COATING IS 0,16mm CHROME COATING
- OUTPUT LENGTH 175mm
- 40 BAR PRESSURE RESISTANT CERAMIC CARTRIDGE USED
- WATER FLOW IS BETWEEN 19 AND 23 PER MINUTE
- THE ROYTER TOOLS WAS MADE BRASS'S
- INSTALLATION CONNECTIONS ARE G ½
- HAND SHOWER CONNECTIONS ARE G ½

12 | 5.040,00₺  
Code: 71 2010 0001

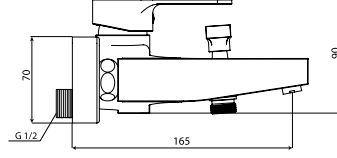

## Mix Kuğu Mutfak Bataryası

- ÜRÜNÜMÜZ MS58 PİRİNÇ MALZEMEDEN ÜRETİLMİŞTİR.
- YÜZEY KAPLAMASI 0,12 İLE 0,16 MİKRON KROM KAPLAMADIR.
- ÇIKIŞ UCU UZUNLUĞU 180 mm'DİR.
- ÇIKIŞ UCU YÜKSEKLİĞİ 320 mm'DİR.
- SU AKIŞ BORUSU ÇAPLI 22, SU AKIŞ BORUSU MS63 PİRİNÇTİR.
- 360 DERECE DÖNER BORULUDUR.
- 40 BAR BASINCA DAYANIKLI SERAMİK KARTUŞ KULLANILMAKTADIR.
- PERLATÖRÜN SU AKIŞ DEBİSİ DAKİKADA 12 İLE 18 lt ARASINDADIR.
- 3/8 M-10 40 BAR BASINCA DAYANIKLI ÇELİK ÖRGÜLÜ FLEX KULLANILMIŞTIR.

## Mix Kitchen Faucet

- OUR PRODUCT IS MADE OF MS58 BRASS
- SURFACE COATING IS 0,16mm CHROME COATING
- OUTPUT LENGTH 180mm
- OUTPUT END PIPE HEIGHT IS 320mm
- THE DIAMETER FO THE PIPE IS 22, THE WATER FLOW PIPE MS63 IS BRASS
- 360 ROTARY PIPE
- 40 BAR PRESSURE RESISTANT CERAMIC CARTRIDGE USED
- WATER FLOW IS BETWEEN 13 AND 18 PER MINUTE
- G 3/8 M-10 40 BAR PRESSURE RESISTANT STEEL BRAIDED FLEX USED

12 | 4.100,00₺  
Code: 71 2010 0002

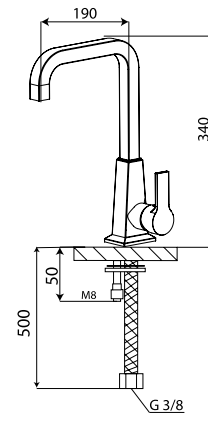

## Mix Kuğu Lavabo Bataryası

- ÜRÜNÜMÜZ MS58 PİRİNÇ MALZEMEDEN ÜRETİLMİŞTİR.
- YÜZEY KAPLAMASI 0,16 MİKRON KROM KAPLAMADIR.
- ÇIKIŞ UCU UZUNLUĞU 120 mm'DİR.
- ÇIKIŞ UCU YÜKSEKLİĞİ 225 mm'DİR.
- SU AKIŞ BORUSU ÇAPLI 22, SU AKIŞ BORUSU MS63 PİRİNÇTİR.
- 360 DERECE DÖNER BORULUDUR.
- 40 BAR BASINCA DAYANIKLI SERAMİK KARTUŞ KULLANILMAKTADIR.
- PERLATÖRÜN SU AKIŞ DEBİSİ DAKİKADA 12 İLE 18 lt ARASINDADIR.
- 3/8 M-10 40 BAR BASINCA DAYANIKLI ÇELİK ÖRGÜLÜ FLEX KULLANILMIŞTIR.

## Mix Basın Faucet

- OUR PRODUCT IS MADE OF MS58 BRASS
- SURFACE COATING IS 0,16mm CHROME COATING
- OUTPUT LENGTH 120mm
- OUTPUT END PIPE HEIGHT IS 225mm
- THE DIAMETER FO THE PIPE IS 18, THE WATER FLOW PIPE MS63 IS BRASS
- 360 ROTARY PIPE
- 40 BAR PRESSURE RESISTANT CERAMIC CARTRIDGE USED
- WATER FLOW IS BETWEEN 13 AND 18 PER MINUTE
- G 3/8 M-10 40 BAR PRESSURE RESISTANT STEEL BRAIDED FLEX USED

12 | 4.100,00₺  
Code: 71 2010 0003

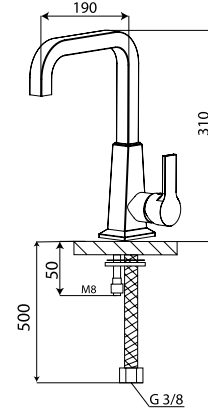

## Mix Duş Bataryası

- ÜRÜNÜMÜZ MS58/MS63 ORANINDA ALÇAK BASINÇ PİRİNÇ KÜLÇEDEN ÜRETİLMİŞTİR.
- YÜZEY KAPLAMASI 0,12 İLE 0,16 MİKRON KROM KAPLAMADIR.
- ÇIKIŞ UCU UZUNLUĞU 175 mm'DİR.
- 40 BAR BASINCA DAYANIKLI SERAMİK KARTUŞ KULLANILMAKTADIR.
- PERLATÖRÜN SU AKIŞ DEBİSİ DAKİKADA 19 İLE 23 lt ARASINDADIR.
- YÖNLENDİRİCİ TAKIMI MS58 PİRİNÇTEN ÜRETİLMİŞTİR.
- TESİSAT BAĞLANTILARI G ½' DİR.
- EL DUŞU BAĞLANTISI G ½' DİR.

## Mix Shower Faucet

- OUR PRODUCT IS MADE OF MS58/MS63 BRASS LOW PRESSURE INGOTS
- SURFACE COATING IS 0,16mm CHROME COATING
- OUTPUT LENGTH 175mm
- 40 BAR PRESSURE RESISTANT CERAMIC CARTRIDGE USED
- WATER FLOW IS BETWEEN 19 AND 23 PER MINUTE
- THE ROYTER TOOLS WAS MADE BRASS'S
- INSTALLATION CONNECTIONS ARE G ½
- HAND SHOWER CONNECTIONS ARE G ½

12 | 3.260,00₺  
Code: 71 2010 0006

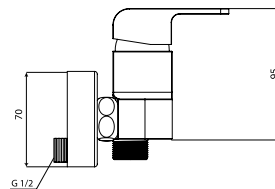

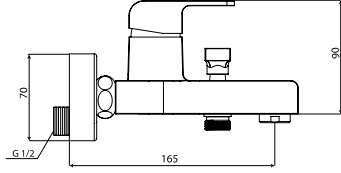

### Mix Banyo Bataryası

- ÜRÜNÜMÜZ MS58/MS63 ORANINDA ALÇAK BASINÇ PİRİNÇ KÜLÇEDEN ÜRETİLMİŞTİR.
- YÜZEY KAPLAMASI 0,12 İLE 0,16 MİKRON KROM KAPLAMADIR.
- ÇIKIŞ UCU UZUNLUĞU 175 mm'DİR.
- 40 BAR BASINCA DAYANIKLI SERAMİK KARTUŞ KULLANILMAKTADIR.
- PERLATÖRÜN SU AKIŞ DEBİSİ DAKİKADA 19 İLE 23 lt ARASINDADIR.
- YÖNLENDİRİCİ TAKIMI MS58 PİRİNÇTEN ÜRETİLMİŞTİR.
- TESİSAT BAĞLANTILARI G ½' DİR.
- EL DUŞU BAĞLANTISI G ½' DİR.

### Mix Bathroom Faucet

- OUR PRODUCT IS MADE OF MS58/MS63 BRASS LOW PRESSURE INGOTS
- SURFACE COATING IS 0,16mm CHROME COATING
- OUTPUT LENGTH 175mm
- 40 BAR PRESSURE RESISTANT CERAMIC CARTRIDGE USED
- WATER FLOW IS BETWEEN 19 AND 23 PER MINUTE
- THE ROYTER TOOLS WAS MADE BRASS'S
- INSTALLATION CONNECTIONS ARE G ½
- HAND SHOWER CONNECTIONS ARE G ½

12 | 4.280,00 ₺  
Code: 70 2010 0001

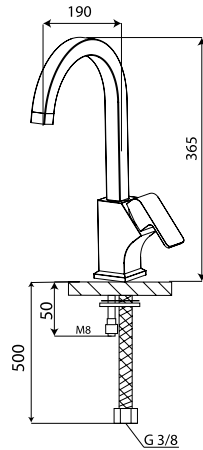

### Mix Baston Boru Mutfak Bataryası

- ÜRÜNÜMÜZ MS58 PİRİNÇ MALZEMEDEN ÜRETİLMİŞTİR.
- YÜZEY KAPLAMASI 0,12 İLE 0,16 MİKRON KROM KAPLAMADIR.
- ÇIKIŞ UCU UZUNLUĞU 180 mm'DİR.
- ÇIKIŞ UCU YÜKSEKLİĞİ 320 mm'DİR.
- SU AKIŞ BORUSU ÇAPI 22, SU AKIŞ BORUSU MS63 PİRİNÇTİR.
- 360 DERECE DÖNER BORULUDUR.
- 40 BAR BASINCA DAYANIKLI SERAMİK KARTUŞ KULLANILMAKTADIR.
- PERLATÖRÜN SU AKIŞ DEBİSİ DAKİKADA 12 İLE 18 lt ARASINDADIR.
- 3/8 M-10 40 BAR BASINCA DAYANIKLI ÇELİK ÖRGÜLÜ FLEX KULLANILMIŞTIR.

### Mix Kitchen Faucet

- OUR PRODUCT IS MADE OF MS58 BRASS
- SURFACE COATING IS 0,16mm CHROME COATING
- OUTPUT LENGTH 180mm
- OUTPUT END PIPE HEIGHT IS 320mm
- THE DIAMETER FO THE PIPE IS 22, THE WATER FLOW PIPE MS63 IS BRASS
- 360 ROTARY PIPE
- 40 BAR PRESSURE RESISTANT CERAMIC CARTRIDGE USED
- WATER FLOW IS BETWEEN 13 AND 18 PER MINUTE
- G 3/8 M-10 40 BAR PRESSURE RESISTANT STEEL BRAIDED FLEX USED

12 | 4.400,00 ₺  
Code: 70 2010 0002

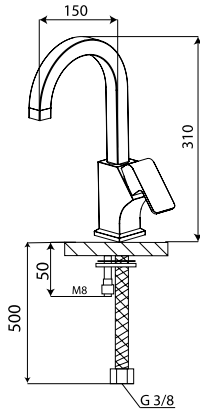

### Mix Baston Boru Lavabo Bataryası

- ÜRÜNÜMÜZ MS58 PİRİNÇ MALZEMEDEN ÜRETİLMİŞTİR.
- YÜZEY KAPLAMASI 0,16 MİKRON KROM KAPLAMADIR.
- ÇIKIŞ UCU UZUNLUĞU 120 mm'DİR.
- ÇIKIŞ UCU YÜKSEKLİĞİ 225 mm'DİR.
- SU AKIŞ BORUSU ÇAPI 22, SU AKIŞ BORUSU MS63 PİRİNÇTİR.
- 360 DERECE DÖNER BORULUDUR.
- 40 BAR BASINCA DAYANIKLI SERAMİK KARTUŞ KULLANILMAKTADIR.
- PERLATÖRÜN SU AKIŞ DEBİSİ DAKİKADA 12 İLE 18 lt ARASINDADIR.
- 3/8 M-10 40 BAR BASINCA DAYANIKLI ÇELİK ÖRGÜLÜ FLEX KULLANILMIŞTIR.

### Mix Basin Faucet

- OUR PRODUCT IS MADE OF MS58 BRASS
- SURFACE COATING IS 0,16mm CHROME COATING
- OUTPUT LENGTH 120mm
- OUTPUT END PIPE HEIGHT IS 225mm
- THE DIAMETER FO THE PIPE IS 18, THE WATER FLOW PIPE MS63 IS BRASS
- 360 ROTARY PIPE
- 40 BAR PRESSURE RESISTANT CERAMIC CARTRIDGE USED
- WATER FLOW IS BETWEEN 13 AND 18 PER MINUTE
- G 3/8 M-10 40 BAR PRESSURE RESISTANT STEEL BRAIDED FLEX USED

12 | 4.400,00 ₺  
Code: 70 2010 0003

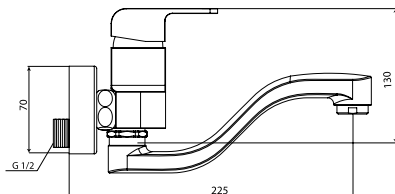

### Mix Aplike Eviye Bataryası

- ÜRÜNÜMÜZ MS58 PİRİNÇ MALZEMEDEN ÜRETİLMİŞTİR.
- YÜZEY KAPLAMASI 0,16 MİKRON KROM KAPLAMADIR.
- ÇIKIŞ UCU UZUNLUĞU 120 mm'DİR.
- ÇIKIŞ UCU YÜKSEKLİĞİ 225 mm'DİR.
- SU AKIŞ BORUSU ÇAPI 22, SU AKIŞ BORUSU MS63 PİRİNÇTİR.
- 360 DERECE DÖNER BORULUDUR.
- 40 BAR BASINCA DAYANIKLI SERAMİK KARTUŞ KULLANILMAKTADIR.
- PERLATÖRÜN SU AKIŞ DEBİSİ DAKİKADA 12 İLE 18 lt ARASINDADIR.
- 3/8 M-10 40 BAR BASINCA DAYANIKLI ÇELİK ÖRGÜLÜ FLEX KULLANILMIŞTIR.

### Applique Kitchen Faucet

- OUR PRODUCT IS MADE OF MS58 BRASS
- SURFACE COATING IS 0,16mm CHROME COATING
- OUTPUT LENGTH 120mm
- OUTPUT END PIPE HEIGHT IS 225mm
- THE DIAMETER FO THE PIPE IS 18, THE WATER FLOW PIPE MS63 IS BRASS
- 360 ROTARY PIPE
- 40 BAR PRESSURE RESISTANT CERAMIC CARTRIDGE USED
- WATER FLOW IS BETWEEN 13 AND 18 PER MINUTE
- G 3/8 M-10 40 BAR PRESSURE RESISTANT STEEL BRAIDED FLEX USED

12 | 4.400,00 ₺  
Code: 70 2010 0009

## Mix Lüks Lavabo Bataryası

- ÜRÜNÜMÜZ MS58/MS63 ORANINDA ALÇAK BASINÇ PİRİNÇ KÜLÇEDEN ÜRETİLMİŞTİR.
- YÜZEY KAPLAMASI 0,12 İLE 0,16 MİKRON KROM KAPLAMADIR.
- ÇIKIŞ UCU UZUNLUĞU 120 mm'DİR.
- ÜRÜN YÜKSEKLİĞİ 165 mm'DİR.
- 40 BAR BASINCA DAYANIKLI SERAMİK KARTUŞ KULLANILMAKTADIR.
- PERLATÖRÜN SU AKIŞ DEBİSİ DAKİKADA19 İLE 23 lt ARASINDADIR.
- 3/8 M-10 40 BAR BASINCA DAYANIKLI ÇELİK ÖRGÜLÜ FLEX KULLANILMIŞTIR.

## Mix Lux Basin Faucet

- OUR PRODUCT IS MADE OF MS58/MS63 BRASS LOW PRESSURE INGOTS
- SURFACE COATING IS 0,16mm CHROME COATING
- OUTPUT LENGTH 120 mm
- PRODUCT HEIGHT 165 mm
- 40 BAR PRESSURE RESISTANT CERAMIC CARTRIDGE USED
- WATER FLOW IS BETWEEN 19 AND 23 PER MINUTE
- G 3/8 M-10 40 BAR PRESSURE RESISTANT STEEL BRAIDED FLEX USED

12 | 4.540,00 ₺  
Code: 70 2010 0007

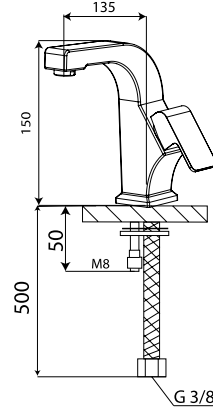

## Mix Kuğu Mutfak Bataryası

- ÜRÜNÜMÜZ MS58 PİRİNÇ MALZEMEDEN ÜRETİLMİŞTİR.
- YÜZEY KAPLAMASI 0,12 İLE 0,16 MİKRON KROM KAPLAMADIR.
- ÇIKIŞ UCU UZUNLUĞU 180 mm'DİR.
- ÇIKIŞ UCU YÜKSEKLİĞİ 320 mm'DİR.
- SU AKIŞ BORUSU ÇAPI 22, SU AKIŞ BORUSU MS63 PİRİNÇTİR.
- 360 DERECE DÖNER BORULUDUR.
- 40 BAR BASINCA DAYANIKLI SERAMİK KARTUŞ KULLANILMAKTADIR.
- PERLATÖRÜN SU AKIŞ DEBİSİ DAKİKADA12 İLE 18 lt ARASINDADIR.
- 3/8 M-10 40 BAR BASINCA DAYANIKLI ÇELİK ÖRGÜLÜ FLEX KULLANILMIŞTIR.

## Mix Kitchen Faucet

- OUR PRODUCT IS MADE OF MS58 BRASS
- SURFACE COATING IS 0,16mm CHROME COATING
- OUTPUT LENGTH 180mm
- OUTPUT END PIPE HEIGHT IS 320mm
- THE DIAMETER FO THE PIPE IS 22, THE WATER FLOW PIPE MS63 IS BRASS
- 360 ROTARY PIPE
- 40 BAR PRESSURE RESISTANT CERAMIC CARTRIDGE USED
- WATER FLOW IS BETWEEN 13 AND 18 PER MINUTE
- G 3/8 M-10 40 BAR PRESSURE RESISTANT STEEL BRAIDED FLEX USED

12 | 4.350,00 ₺  
Code: 70 2010 0004

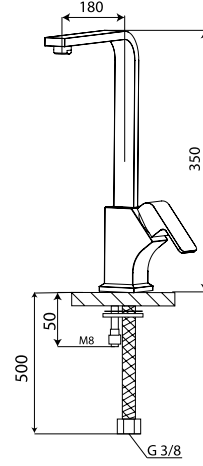

## Mix Kuğu Lavabo Bataryası

- ÜRÜNÜMÜZ MS58 PİRİNÇ MALZEMEDEN ÜRETİLMİŞTİR.
- YÜZEY KAPLAMASI 0,16 MİKRON KROM KAPLAMADIR.
- ÇIKIŞ UCU UZUNLUĞU 120 mm'DİR.
- ÇIKIŞ UCU YÜKSEKLİĞİ 225 mm'DİR.
- SU AKIŞ BORUSU ÇAPI 22, SU AKIŞ BORUSU MS63 PİRİNÇTİR.
- 360 DERECE DÖNER BORULUDUR.
- 40 BAR BASINCA DAYANIKLI SERAMİK KARTUŞ KULLANILMAKTADIR.
- PERLATÖRÜN SU AKIŞ DEBİSİ DAKİKADA12 İLE 18 lt ARASINDADIR.
- 3/8 M-10 40 BAR BASINCA DAYANIKLI ÇELİK ÖRGÜLÜ FLEX KULLANILMIŞTIR.

## Mix Basin Faucet

- OUR PRODUCT IS MADE OF MS58 BRASS
- SURFACE COATING IS 0,16mm CHROME COATING
- OUTPUT LENGTH 120mm
- OUTPUT END PIPE HEIGHT IS 225mm
- THE DIAMETER FO THE PIPE IS 18, THE WATER FLOW PIPE MS63 IS BRASS
- 360 ROTARY PIPE
- 40 BAR PRESSURE RESISTANT CERAMIC CARTRIDGE USED
- WATER FLOW IS BETWEEN 13 AND 18 PER MINUTE
- G 3/8 M-10 40 BAR PRESSURE RESISTANT STEEL BRAIDED FLEX USED

12 | 4.350,00 ₺  
Code: 70 2010 0005

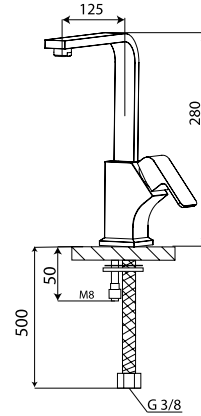

## Mix Döküm Lavabo Bataryası

- ÜRÜNÜMÜZ MS58/MS63 ORANINDA ALÇAK BASINÇ PİRİNÇ KÜLÇEDEN ÜRETİLMİŞTİR.
- YÜZEY KAPLAMASI 0,12 İLE 0,16 MİKRON KROM KAPLAMADIR.
- YÜZEY KAPLAMASI ÖZEL ALTIN BOYADIR.
- YÜZEY KAPLAMASI PULVER 916 BOYADIR.
- ÇIKIŞ UCU UZUNLUĞU 120 mm'DİR.
- ÜRÜN YÜKSEKLİĞİ 360 mm'DİR.
- 40 BAR BASINCA DAYANIKLI SERAMİK KARTUŞ KULLANILMAKTADIR.
- PERLATÖRÜN SU AKIŞ DEBİSİ DAKİKADA19 İLE 23 lt ARASINDADIR.
- 3/8 M-10 40 BAR BASINCA DAYANIKLI ÇELİK ÖRGÜLÜ FLEX KULLANILMIŞTIR.

## Mix High Basin Faucet

- OUR PRODUCT IS MADE OF MS58/MS63 BRASS LOW PRESSURE INGOTS
- SURFACE COATING IS 0,16mm CHROME COATING
- SURFACE COATING IS SPECIAL GOLD PAINT.
- SURFACE COATING IS PAINTED 916.
- OUTPUT LENGTH 120 mm
- PRODUCT HEIGHT 360 mm
- 40 BAR PRESSURE RESISTANT CERAMIC CARTRIDGE USED
- WATER FLOW IS BETWEEN 19 AND 23 PER MINUTE
- G 3/8 M-10 40 BAR PRESSURE RESISTANT STEEL BRAIDED FLEX USED

12 | 4.350,00 ₺  
Code: 70 2010 0006

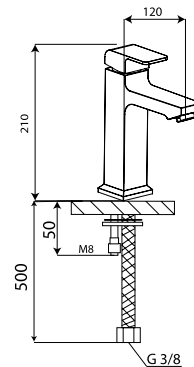

**MAT SİYAH**

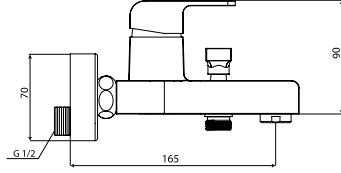

**Mix Banyo Bataryası**

- ÜRÜNÜMÜZ MS58/MS63 ORANINDA ALÇAK BASINÇ PİRİNÇ KÜLÇEDEN ÜRETİLMİŞTİR.
- YÜZEY KAPLAMASI 0,12 İLE 0,16 MİKRON KROM KAPLAMADIR.
- ÇIKIŞ UCU UZUNLUĞU 175 mm'DİR.
- 40 BAR BASINCA DAYANIKLI SERAMİK KARTUŞ KULLANILMAKTADIR.
- PERLATÖRÜN SU AKIŞ DEBİSİ DAKİKADA 19 İLE 23 lt ARASINDADIR.
- YÖNLENDİRİCİ TAKIMI MS58 PİRİNÇTEN ÜRETİLMİŞTİR.
- TESİSAT BAĞLANTILARI G ½' DİR.
- EL DUŞU BAĞLANTISI G ½' DİR.

**Mix Bathroom Faucet**

- OUR PRODUCT IS MADE OF MS58/MS63 BRASS LOW PRESSURE INGOTS
- SURFACE COATING IS 0,16mm CHROME COATING
- OUTPUT LENGTH 175mm
- 40 BAR PRESSURE RESISTANT CERAMIC CARTRIDGE USED
- WATER FLOW IS BETWEEN 19 AND 23 PER MINUTE
- THE ROYTER TOOLS WAS MADE BRASS'S
- INSTALLATION CONNECTIONS ARE G ½
- HAND SHOWER CONNECTIONS ARE G ½

**Mat Siyah**

4 | 4.700,00₺

Code: 70 2010 0024

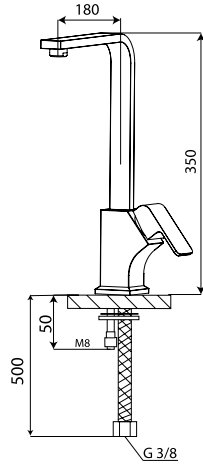

**Mix Kuğu Mutfak Bataryası**

- ÜRÜNÜMÜZ MS58 PİRİNÇ MALZEMEDEN ÜRETİLMİŞTİR.
- YÜZEY KAPLAMASI 0,12 İLE 0,16 MİKRON KROM KAPLAMADIR.
- ÇIKIŞ UCU UZUNLUĞU 180 mm'DİR.
- ÇIKIŞ UCU YÜKSEKLİĞİ 320 mm'DİR.
- SU AKIŞ BORUSU ÇAPI 22, SU AKIŞ BORUSU MS63 PİRİNÇTİR.
- 360 DERECE DÖNER BORULUDUR.
- 40 BAR BASINCA DAYANIKLI SERAMİK KARTUŞ KULLANILMAKTADIR.
- PERLATÖRÜN SU AKIŞ DEBİSİ DAKİKADA 12 İLE 18 lt ARASINDADIR.
- 3/8 M-10 40 BAR BASINCA DAYANIKLI ÇELİK ÖRGÜLÜ FLEX KULLANILMIŞTIR.

**Mix Kitchen Faucet**

- OUR PRODUCT IS MADE OF MS58 BRASS
- SURFACE COATING IS 0,16mm CHROME COATING
- OUTPUT LENGTH 180mm
- OUTPUT END PIPE HEIGHT IS 320mm
- THE DIAMETER FO THE PIPE IS 22, THE WATER FLOW PIPE MS63 IS BRASS
- 360 ROTARY PIPE
- 40 BAR PRESSURE RESISTANT CERAMIC CARTRIDGE USED
- WATER FLOW IS BETWEEN 13 AND 18 PER MINUTE
- G 3/8 M-10 40 BAR PRESSURE RESISTANT STEEL BRAIDED FLEX USED

**Mat Siyah**

4 | 4.700,00₺

Code: 70 2010 0025

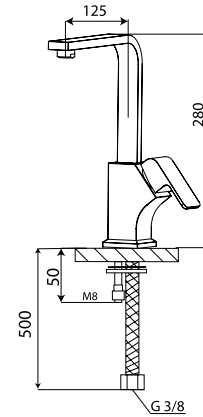

**Mix Kuğu Lavabo Bataryası**

- ÜRÜNÜMÜZ MS58 PİRİNÇ MALZEMEDEN ÜRETİLMİŞTİR.
- YÜZEY KAPLAMASI 0,16 MİKRON KROM KAPLAMADIR.
- ÇIKIŞ UCU UZUNLUĞU 120 mm'DİR.
- ÇIKIŞ UCU YÜKSEKLİĞİ 225 mm'DİR.
- SU AKIŞ BORUSU ÇAPI 22, SU AKIŞ BORUSU MS63 PİRİNÇTİR.
- 360 DERECE DÖNER BORULUDUR.
- 40 BAR BASINCA DAYANIKLI SERAMİK KARTUŞ KULLANILMAKTADIR.
- PERLATÖRÜN SU AKIŞ DEBİSİ DAKİKADA 12 İLE 18 lt ARASINDADIR.
- 3/8 M-10 40 BAR BASINCA DAYANIKLI ÇELİK ÖRGÜLÜ FLEX KULLANILMIŞTIR.

**Mix Basin Faucet**

- OUR PRODUCT IS MADE OF MS58 BRASS
- SURFACE COATING IS 0,16mm CHROME COATING
- OUTPUT LENGTH 120mm
- OUTPUT END PIPE HEIGHT IS 225mm
- THE DIAMETER FO THE PIPE IS 18, THE WATER FLOW PIPE MS63 IS BRASS
- 360 ROTARY PIPE
- 40 BAR PRESSURE RESISTANT CERAMIC CARTRIDGE USED
- WATER FLOW IS BETWEEN 13 AND 18 PER MINUTE
- G 3/8 M-10 40 BAR PRESSURE RESISTANT STEEL BRAIDED FLEX USED

**Mat Siyah**

4 | 4.700,00₺

Code: 70 2010 0026

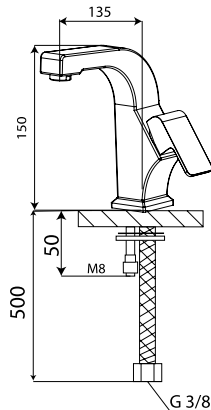

**Mix Lavabo Bataryası**

- ÜRÜNÜMÜZ MS58/MS63 ORANINDA ALÇAK BASINÇ PİRİNÇ KÜLÇEDEN ÜRETİLMİŞTİR.
- YÜZEY KAPLAMASI 0,12 İLE 0,16 MİKRON KROM KAPLAMADIR.
- ÇIKIŞ UCU UZUNLUĞU 120 mm'DİR.
- ÜRÜN YÜKSEKLİĞİ 165 mm'DİR.
- 40 BAR BASINCA DAYANIKLI SERAMİK KARTUŞ KULLANILMAKTADIR.
- PERLATÖRÜN SU AKIŞ DEBİSİ DAKİKADA 19 İLE 23 lt ARASINDADIR.
- 3/8 M-10 40 BAR BASINCA DAYANIKLI ÇELİK ÖRGÜLÜ FLEX KULLANILMIŞTIR.

**Mix Basin Faucet**

- OUR PRODUCT IS MADE OF MS58/MS63 BRASS LOW PRESSURE INGOTS
- SURFACE COATING IS 0,16mm CHROME COATING
- OUTPUT LENGTH 120 mm
- PRODUCT HEIGHT 165 mm
- 40 BAR PRESSURE RESISTANT CERAMIC CARTRIDGE USED
- WATER FLOW IS BETWEEN 19 AND 23 PER MINUTE
- G 3/8 M-10 40 BAR PRESSURE RESISTANT STEEL BRAIDED FLEX USED

**Mat Siyah**

4 | 4.950,00₺

Code: 70 2010 0030

## MAT SİYAH

**Mix Baston Boru Mutfak Bataryası**

- ÜRÜNÜMÜZ MS58 PİRİNÇ MALZEMEDEN ÜRETİLMİŞTİR.
- YÜZEY KAPLAMASI 0,12 İLE 0,16 MİKRON KROM KAPLAMADIR.
- ÇIKIŞ UCU UZUNLUĞU 180 mm'DİR.
- ÇIKIŞ UCU YÜKSEKLİĞİ 320 mm'DİR.
- SU AKIŞ BORUSU ÇAPI 22, SU AKIŞ BORUSU MS63 PİRİNÇTİR.
- 360 DERECE DÖNER BORULUDUR.
- 40 BAR BASINCA DAYANIKLI SERAMİK KARTUŞ KULLANILMAKTADIR.
- PERLATÖRÜN SU AKIŞ DEBİSİ DAKİKADA 12 İLE 18 lt ARASINDADIR.
- 3/8 M-10 40 BAR BASINCA DAYANIKLI ÇELİK ÖRGÜLÜ FLEX KULLANILMIŞTIR.

**Mix Kitchen Faucet**

- OUR PRODUCT IS MADE OF MS58 BRASS
- SURFACE COATING IS 0,16mm CHROME COATING
- OUTPUT LENGTH 180mm
- OUTPUT END PIPE HEIGHT IS 320mm
- THE DIAMETER FO THE PIPE IS 22, THE WATER FLOW PIPE MS63 IS BRASS
- 360 ROTARY PIPE
- 40 BAR PRESSURE RESISTANT CERAMIC CARTRIDGE USED
- WATER FLOW IS BETWEEN 13 AND 18 PER MINUTE
- G 3/8 M-10 40 BAR PRESSURE RESISTANT STEEL BRAIDED FLEX USED

**Mat Siyah**

4 | 4.700,00₺

Code: 70 2010 0027

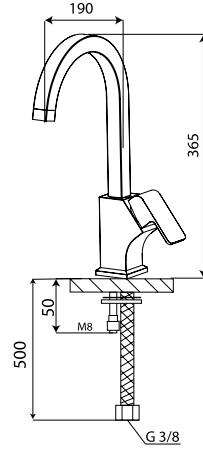
**Mix Baston Boru Lavabo Bataryası**

- ÜRÜNÜMÜZ MS58 PİRİNÇ MALZEMEDEN ÜRETİLMİŞTİR.
- YÜZEY KAPLAMASI 0,16 MİKRON KROM KAPLAMADIR.
- ÇIKIŞ UCU UZUNLUĞU 120 mm'DİR.
- ÇIKIŞ UCU YÜKSEKLİĞİ 225 mm'DİR.
- SU AKIŞ BORUSU ÇAPI 22, SU AKIŞ BORUSU MS63 PİRİNÇTİR.
- 360 DERECE DÖNER BORULUDUR.
- 40 BAR BASINCA DAYANIKLI SERAMİK KARTUŞ KULLANILMAKTADIR.
- PERLATÖRÜN SU AKIŞ DEBİSİ DAKİKADA 12 İLE 18 lt ARASINDADIR.
- 3/8 M-10 40 BAR BASINCA DAYANIKLI ÇELİK ÖRGÜLÜ FLEX KULLANILMIŞTIR.

**Mix Basin Faucet**

- OUR PRODUCT IS MADE OF MS58 BRASS
- SURFACE COATING IS 0,16mm CHROME COATING
- OUTPUT LENGTH 120mm
- OUTPUT END PIPE HEIGHT IS 225mm
- THE DIAMETER FO THE PIPE IS 18, THE WATER FLOW PIPE MS63 IS BRASS
- 360 ROTARY PIPE
- 40 BAR PRESSURE RESISTANT CERAMIC CARTRIDGE USED
- WATER FLOW IS BETWEEN 13 AND 18 PER MINUTE
- G 3/8 M-10 40 BAR PRESSURE RESISTANT STEEL BRAIDED FLEX USED

**Mat Siyah**

4 | 4.700,00₺

Code: 70 2010 0028

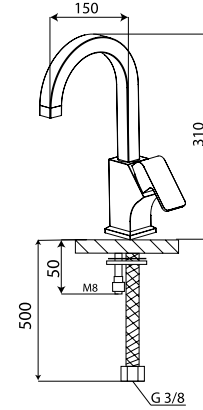
**Mix Lavabo Bataryası**

- ÜRÜNÜMÜZ MS58/MS63 ORANINDA ALÇAK BASINÇ PİRİNÇ KÜLÇEDEN ÜRETİLMİŞTİR.
- YÜZEY KAPLAMASI 0,12 İLE 0,16 MİKRON KROM KAPLAMADIR.
- YÜZEY KAPLAMASI ÖZEL ALTIN BOYADIR.
- YÜZEY KAPLAMASI PULVER 916 BOYADIR.
- ÇIKIŞ UCU UZUNLUĞU 120 mm'DİR.
- ÜRÜN YÜKSEKLİĞİ 360 mm'DİR.
- 40 BAR BASINCA DAYANIKLI SERAMİK KARTUŞ KULLANILMAKTADIR.
- PERLATÖRÜN SU AKIŞ DEBİSİ DAKİKADA 19 İLE 23 lt ARASINDADIR.
- 3/8 M-10 40 BAR BASINCA DAYANIKLI ÇELİK ÖRGÜLÜ FLEX KULLANILMIŞTIR.

**Mix High Basin Faucet**

- OUR PRODUCT IS MADE OF MS58/MS63 BRASS LOW PRESSURE INGOTS
- SURFACE COATING IS 0,16mm CHROME COATING
- SURFACE COATING IS SPECIAL GOLD PAINT.
- SURFACE COATING IS PAINTED 916.
- OUTPUT LENGTH 120 mm
- PRODUCT HEIGHT 360 mm
- 40 BAR PRESSURE RESISTANT CERAMIC CARTRIDGE USED
- WATER FLOW IS BETWEEN 19 AND 23 PER MINUTE
- G 3/8 M-10 40 BAR PRESSURE RESISTANT STEEL BRAIDED FLEX USED

**Mat Siyah**

4 | 4.950,00₺

Code: 70 2010 0029

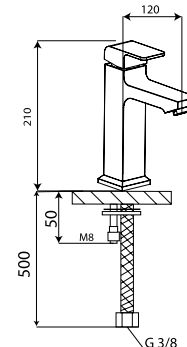

GOLD

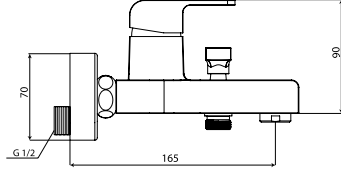

**Mix Banyo Bataryası**

- ÜRÜNÜMÜZ MS58/MS63 ORANINDA ALÇAK BASINÇ PİRİNÇ KÜLÇEDEN ÜRETİLMİŞTİR.
- YÜZEY KAPLAMASI 0,12 İLE 0,16 MİKRON KROM KAPLAMADIR.
- ÇIKIŞ UCU UZUNLUĞU 175 mm'DİR.
- 40 BAR BASINCA DAYANIKLI SERAMİK KARTUŞ KULLANILMAKTADIR.
- PERLATÖRÜN SU AKIŞ DEBİSİ DAKİKADA 19 İLE 23 lt ARASINDADIR.
- YÖNLENDİRİCİ TAKIMI MS58 PİRİNÇTEN ÜRETİLMİŞTİR.
- TESİSAT BAĞLANTILARI G ½' DİR.
- EL DUŞU BAĞLANTISI G ½' DİR.

**Mix Bathroom Faucet**

- OUR PRODUCT IS MADE OF MS58/MS63 BRASS LOW PRESSURE INGOTS
- SURFACE COATING IS 0,16mm CHROME COATING
- OUTPUT LENGTH 175mm
- 40 BAR PRESSURE RESISTANT CERAMIC CARTRIDGE USED
- WATER FLOW IS BETWEEN 19 AND 23 PER MINUTE
- THE ROYTER TOOLS WAS MADE BRASS'S
- INSTALLATION CONNECTIONS ARE G ½
- HAND SHOWER CONNECTIONS ARE G ½

Altın

4 | 5.750,00 ₺

Code: 70 2010 0020

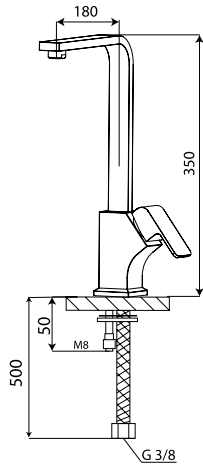

**Mix Kuğu Mutfak Bataryası**

- ÜRÜNÜMÜZ MS58 PİRİNÇ MALZEMEDEN ÜRETİLMİŞTİR.
- YÜZEY KAPLAMASI 0,12 İLE 0,16 MİKRON KROM KAPLAMADIR.
- ÇIKIŞ UCU UZUNLUĞU 180 mm'DİR.
- ÇIKIŞ UCU YÜKSEKLİĞİ 320 mm'DİR.
- SU AKIŞ BORUSU ÇAPI 22, SU AKIŞ BORUSU MS63 PİRİNÇTİR.
- 360 DERECE DÖNER BORULUDUR.
- 40 BAR BASINCA DAYANIKLI SERAMİK KARTUŞ KULLANILMAKTADIR.
- PERLATÖRÜN SU AKIŞ DEBİSİ DAKİKADA 12 İLE 18 lt ARASINDADIR.
- 3/8 M-10 40 BAR BASINCA DAYANIKLI ÇELİK ÖRGÜLÜ FLEX KULLANILMIŞTIR.

**Mix Kitchen Faucet**

- OUR PRODUCT IS MADE OF MS58 BRASS
- SURFACE COATING IS 0,16mm CHROME COATING
- OUTPUT LENGTH 180mm
- OUTPUT END PIPE HEIGHT IS 320mm
- THE DIAMETER FO THE PIPE IS 22, THE WATER FLOW PIPE MS63 IS BRASS
- 360 ROTARY PIPE
- 40 BAR PRESSURE RESISTANT CERAMIC CARTRIDGE USED
- WATER FLOW IS BETWEEN 13 AND 18 PER MINUTE
- G 3/8 M-10 40 BAR PRESSURE RESISTANT STEEL BRAIDED FLEX USED

Altın

4 | 5.750,00 ₺

Code: 70 2010 0021

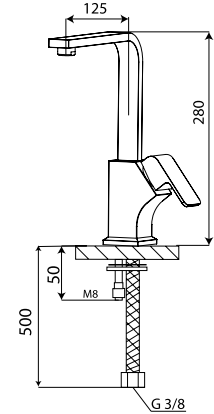

**Mix Kuğu Lavabo Bataryası**

- ÜRÜNÜMÜZ MS58 PİRİNÇ MALZEMEDEN ÜRETİLMİŞTİR.
- YÜZEY KAPLAMASI 0,16 MİKRON KROM KAPLAMADIR.
- ÇIKIŞ UCU UZUNLUĞU 120 mm'DİR.
- ÇIKIŞ UCU YÜKSEKLİĞİ 225 mm'DİR.
- SU AKIŞ BORUSU ÇAPI 22, SU AKIŞ BORUSU MS63 PİRİNÇTİR.
- 360 DERECE DÖNER BORULUDUR.
- 40 BAR BASINCA DAYANIKLI SERAMİK KARTUŞ KULLANILMAKTADIR.
- PERLATÖRÜN SU AKIŞ DEBİSİ DAKİKADA 12 İLE 18 lt ARASINDADIR.
- 3/8 M-10 40 BAR BASINCA DAYANIKLI ÇELİK ÖRGÜLÜ FLEX KULLANILMIŞTIR.

**Mix Basin Faucet**

- OUR PRODUCT IS MADE OF MS58 BRASS
- SURFACE COATING IS 0,16mm CHROME COATING
- OUTPUT LENGTH 120mm
- OUTPUT END PIPE HEIGHT IS 225mm
- THE DIAMETER FO THE PIPE IS 18, THE WATER FLOW PIPE MS63 IS BRASS
- 360 ROTARY PIPE
- 40 BAR PRESSURE RESISTANT CERAMIC CARTRIDGE USED
- WATER FLOW IS BETWEEN 13 AND 18 PER MINUTE
- G 3/8 M-10 40 BAR PRESSURE RESISTANT STEEL BRAIDED FLEX USED

Altın

4 | 5.750,00 ₺

Code: 70 2010 0022

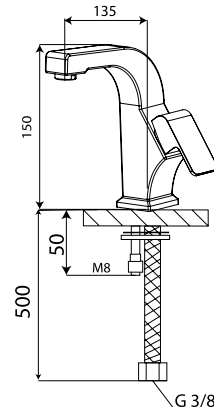

**Mix Lavabo Bataryası**

- ÜRÜNÜMÜZ MS58/MS63 ORANINDA ALÇAK BASINÇ PİRİNÇ KÜLÇEDEN ÜRETİLMİŞTİR.
- YÜZEY KAPLAMASI 0,12 İLE 0,16 MİKRON KROM KAPLAMADIR.
- ÇIKIŞ UCU UZUNLUĞU 120 mm'DİR.
- ÜRÜN YÜKSEKLİĞİ 165 mm'DİR.
- 40 BAR BASINCA DAYANIKLI SERAMİK KARTUŞ KULLANILMAKTADIR.
- PERLATÖRÜN SU AKIŞ DEBİSİ DAKİKADA 19 İLE 23 lt ARASINDADIR.
- 3/8 M-10 40 BAR BASINCA DAYANIKLI ÇELİK ÖRGÜLÜ FLEX KULLANILMIŞTIR.

**Mix Basin Faucet**

- OUR PRODUCT IS MADE OF MS58/MS63 BRASS LOW PRESSURE INGOTS
- SURFACE COATING IS 0,16mm CHROME COATING
- OUTPUT LENGTH 120 mm
- PRODUCT HEIGHT 165 mm
- 40 BAR PRESSURE RESISTANT CERAMIC CARTRIDGE USED
- WATER FLOW IS BETWEEN 19 AND 23 PER MINUTE
- G 3/8 M-10 40 BAR PRESSURE RESISTANT STEEL BRAIDED FLEX USED

Altın

4 | 5.950,00 ₺

Code: 70 2010 0023



**Mix Baston Boru Mutfak Bataryası**

- ÜRÜNÜMÜZ MS58 PİRİNÇ MALZEMEDEN ÜRETİLMİŞTİR.
- YÜZEY KAPLAMASI 0,12 İLE 0,16 MİKRON KROM KAPLAMADIR.
- ÇIKIŞ UCU UZUNLUĞU 180 mm'DİR.
- ÇIKIŞ UCU YÜKSEKLİĞİ 320 mm'DİR.
- SU AKIŞ BORUSU ÇAPİ 22, SU AKIŞ BORUSU MS63 PİRİNÇTİR.
- 360 DERECE DÖNER BORULUDUR.
- 40 BAR BASINCA DAYANIKLI SERAMİK KARTUŞ KULLANILMAKTADIR.
- PERLATÖRÜN SU AKIŞ DEBİSİ DAKİKADA12 İLE 18 lt ARASINDADIR.
- 3/8 M-10 40 BAR BASINCA DAYANIKLI ÇELİK ÖRGÜLÜ FLEX KULLANILMIŞTIR.

**Mix Kitchen Faucet**

- OUR PRODUCT IS MADE OF MS58 BRASS
- SURFACE COATING IS 0,16mm CHROME COATING
- OUTPUT LENGTH 180mm
- OUTPUT END PIPE HEIGHT IS 320mm
- THE DIAMETER FO THE PIPE IS 22, THE WATER FLOW PIPE MS63 IS BRASS
- 360 ROTARY PIPE
- 40 BAR PRESSURE RESISTANT CERAMIC CARTRIDGE USED
- WATER FLOW IS BETWEEN 13 AND 18 PER MINUTE
- G 3/8 M-10 40 BAR PRESSURE RESISTANT STEEL BRAIDED FLEX USED

 Altın

 4 | 5.750,00₺

Code: 70 2010 0031

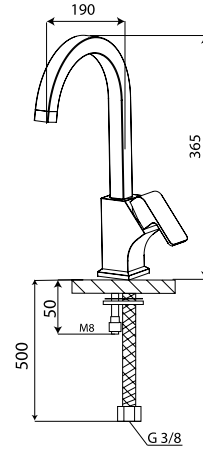
**Mix Baston Boru Lavabo Bataryası**

- ÜRÜNÜMÜZ MS58 PİRİNÇ MALZEMEDEN ÜRETİLMİŞTİR.
- YÜZEY KAPLAMASI 0,16 MİKRON KROM KAPLAMADIR.
- ÇIKIŞ UCU UZUNLUĞU 120 mm'DİR.
- ÇIKIŞ UCU YÜKSEKLİĞİ 225 mm'DİR.
- SU AKIŞ BORUSU ÇAPİ 22, SU AKIŞ BORUSU MS63 PİRİNÇTİR.
- 360 DERECE DÖNER BORULUDUR.
- 40 BAR BASINCA DAYANIKLI SERAMİK KARTUŞ KULLANILMAKTADIR.
- PERLATÖRÜN SU AKIŞ DEBİSİ DAKİKADA12 İLE 18 lt ARASINDADIR.
- 3/8 M-10 40 BAR BASINCA DAYANIKLI ÇELİK ÖRGÜLÜ FLEX KULLANILMIŞTIR.

**Mix Basin Faucet**

- OUR PRODUCT IS MADE OF MS58 BRASS
- SURFACE COATING IS 0,16mm CHROME COATING
- OUTPUT LENGTH 120mm
- OUTPUT END PIPE HEIGHT IS 225mm
- THE DIAMETER FO THE PIPE IS 18, THE WATER FLOW PIPE MS63 IS BRASS
- 360 ROTARY PIPE
- 40 BAR PRESSURE RESISTANT CERAMIC CARTRIDGE USED
- WATER FLOW IS BETWEEN 13 AND 18 PER MINUTE
- G 3/8 M-10 40 BAR PRESSURE RESISTANT STEEL BRAIDED FLEX USED

 Altın

 4 | 5.750,00₺

Code: 70 2010 0032

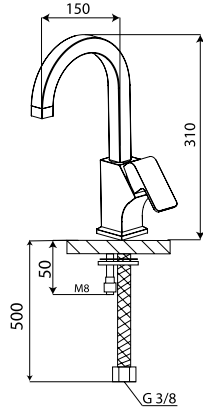
**Mix Lavabo Bataryası**

- ÜRÜNÜMÜZ MS58/MS63 ÖRANINDA ALÇAK BASINÇ PİRİNÇ KÜLÇEDEN ÜRETİLMİŞTİR.
- YÜZEY KAPLAMASI 0,12 İLE 0,16 MİKRON KROM KAPLAMADIR.
- YÜZEY KAPLAMASI ÖZEL ALTIN BOYADIR.
- YÜZEY KAPLAMASI PULVER 916 BOYADIR.
- ÇIKIŞ UCU UZUNLUĞU 120 mm'DİR.
- ÜRÜN YÜKSEKLİĞİ 360 mm'DİR.
- 40 BAR BASINCA DAYANIKLI SERAMİK KARTUŞ KULLANILMAKTADIR.
- PERLATÖRÜN SU AKIŞ DEBİSİ DAKİKADA19 İLE 23 lt ARASINDADIR.
- 3/8 M-10 40 BAR BASINCA DAYANIKLI ÇELİK ÖRGÜLÜ FLEX KULLANILMIŞTIR.

**Mix High Basin Faucet**

- OUR PRODUCT IS MADE OF MS58/MS63 BRASS LOW PRESSURE INGOTS
- SURFACE COATING IS 0,16mm CHROME COATING
- SURFACE COATING IS SPECIAL GOLD PAINT.
- SURFACE COATING IS PAINTED 916.
- OUTPUT LENGTH 120 mm
- PRODUCT HEIGHT 360 mm
- 40 BAR PRESSURE RESISTANT CERAMIC CARTRIDGE USED
- WATER FLOW IS BETWEEN 19 AND 23 PER MINUTE
- G 3/8 M-10 40 BAR PRESSURE RESISTANT STEEL BRAIDED FLEX USED

 Altın

 4 | 5.950,00₺

Code: 70 2010 0033

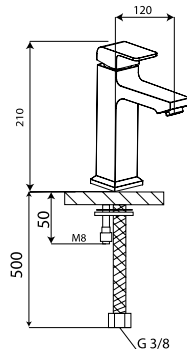

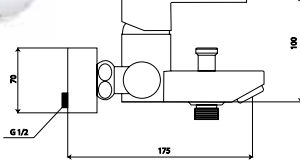

### Mix Banyo Bataryası

- ÜRÜNÜMÜZ MS58/MS63 ORANINDA ALÇAK BASINÇ PİRİNÇ KÜLÇEDEN ÜRETİLMİŞTİR.
- YÜZEY KAPLAMASI 0,12 İLE 0,16 MİKRON KROM KAPLAMADIR.
- ÇIKIŞ UCU UZUNLUĞU 150 mm'DİR.
- 40 BAR BASINCA DAYANIKLI SERAMİK KARTUŞ KULLANILMAKTADIR.
- PERLATÖRÜN SU AKIŞ DEBİSİ DAKİKADA 19 İLE 23 lt ARASINDADIR.
- YÖNLENDİRİCİ TAKIMI MS58 PİRİNÇTEN ÜRETİLMİŞTİR.
- TESİSAT BAĞLANTILARI G ½' DİR.
- EL DUŞU BAĞLANTISI G ½' DİR.

### Mix Bathroom Faucet

- OUR PRODUCT IS MADE OF MS58/MS63 BRASS LOW PRESSURE INGOTS
- SURFACE COATING IS 0,16mm CHROME COATING
- OUTPUT LENGTH 150mm
- 40 BAR PRESSURE RESISTANT CERAMIC CARTRIDGE USED
- WATER FLOW IS BETWEEN 19 AND 23 PER MINUTE
- THE ROYTER TOOLS WAS MADE BRASS'S
- INSTALLATION CONNECTIONS ARE G ½
- HAND SHOWER CONNECTIONS ARE G ½

12 | 2.990,00 ₺

Code: 82 2018 0060

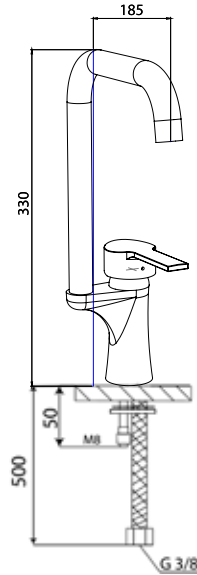

### Mix Kuğu Mutfak Bataryası

- ÜRÜNÜMÜZ MS58 PİRİNÇ MALZEMEDEN ÜRETİLMİŞTİR.
- YÜZEY KAPLAMASI 0,12 İLE 0,16 MİKRON KROM KAPLAMADIR.
- ÇIKIŞ UCU UZUNLUĞU 185 mm'DİR.
- ÇIKIŞ UCU YÜKSEKLİĞİ 345 mm'DİR.
- SU AKIŞ BORUSU ÇAPI 22mm, SU AKIŞ BORUSU MS63 PİRİNÇTİR.
- 360 DERECE DÖNER BORULUDUR.
- 40 BAR BASINCA DAYANIKLI SERAMİK KARTUŞ KULLANILMAKTADIR.
- PERLATÖRÜN SU AKIŞ DEBİSİ DAKİKADA 12 İLE 18 lt ARASINDADIR.
- 3/8 M-10 40 BAR BASINCA DAYANIKLI ÇELİK ÖRGÜLÜ FLEX KULLANILMIŞTIR.

### Mix Kitchen Faucet

- OUR PRODUCT IS MADE OF MS58 BRASS
- SURFACE COATING IS 0,16mm CHROME COATING
- OUTPUT LENGTH 185mm
- OUTPUT END PIPE HEIGHT IS 345mm
- THE DIAMETER FO THE PIPE IS 22, THE WATER FLOW PIPE MS63 IS BRASS
- 360 ROTARY PIPE
- 40 BAR PRESSURE RESISTANT CERAMIC CARTRIDGE USED
- WATER FLOW IS BETWEEN 13 AND 18 PER MINUTE
- G 3/8 M-10 40 BAR PRESSURE RESISTANT STEEL BRAIDED FLEX USED

12 | 1.786,00 ₺

Code: 82 2018 0061

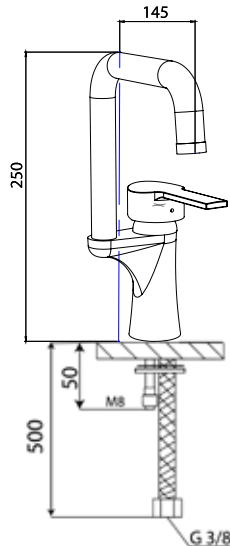

### Mix Kuğu Lavabo Bataryası

- ÜRÜNÜMÜZ MS58 PİRİNÇ MALZEMEDEN ÜRETİLMİŞTİR.
- YÜZEY KAPLAMASI 0,16 MİKRON KROM KAPLAMADIR.
- ÇIKIŞ UCU UZUNLUĞU 140 mm'DİR.
- ÇIKIŞ UCU YÜKSEKLİĞİ 270 mm'DİR.
- SU AKIŞ BORUSU ÇAPI 22mm, SU AKIŞ BORUSU MS63 PİRİNÇ.
- 360 DERECE DÖNER BORULUDUR.
- 40 BAR BASINCA DAYANIKLI SERAMİK KARTUŞ KULLANILMAKTADIR.
- PERLATÖRÜN SU AKIŞ DEBİSİ DAKİKADA 12 İLE 18 lt ARASINDADIR.
- 3/8 M-10 40 BAR BASINCA DAYANIKLI ÇELİK ÖRGÜLÜ FLEX KULLANILMIŞTIR.

### Mix Basin Faucet

- OUR PRODUCT IS MADE OF MS58 BRASS
- SURFACE COATING IS 0,16mm CHROME COATING
- OUTPUT LENGTH 140mm
- OUTPUT END PIPE HEIGHT IS 270mm
- THE DIAMETER FO THE PIPE IS 22, THE WATER FLOW PIPE MS63 IS BRASS
- 360 ROTARY PIPE
- 40 BAR PRESSURE RESISTANT CERAMIC CARTRIDGE USED
- WATER FLOW IS BETWEEN 13 AND 18 PER MINUTE
- G 3/8 M-10 40 BAR PRESSURE RESISTANT STEEL BRAIDED FLEX USED

12 | 1.786,00 ₺

Code: 82 2018 0062

### Mix Kuğu Mutfak Bataryası

- ÜRÜNÜMÜZ MS58 PİRİNÇ MALZEMEDEN ÜRETİLMİŞTİR.
- YÜZEY KAPLAMASI 0,12 İLE 0,16 MİKRON KROM KAPLAMADIR.
- ÇIKIŞ UCU UZUNLUĞU 185 mm'DİR.
- ÇIKIŞ UCU YÜKSEKLİĞİ 345 mm'DİR.
- SU AKIŞ BORUSU ÇAPI 22mm, SU AKIŞ BORUSU MS63 PİRİNÇTİR.
- 360 DERECE DÖNER BORULUDUR.
- 40 BAR BASINCA DAYANIKLI SERAMİK KARTUŞ KULLANILMAKTADIR.
- PERLATÖRÜN SU AKIŞ DEBİSİ DAKİKADA 12 İLE 18 lt ARASINDADIR.
- 3/8 M-10 40 BAR BASINCA DAYANIKLI ÇELİK ÖRGÜLÜ FLEX KULLANILMIŞTIR.

### Mix Kitchen Faucet

- OUR PRODUCT IS MADE OF MS58 BRASS
- SURFACE COATING IS 0,16mm CHROME COATING
- OUTPUT LENGTH 185mm
- OUTPUT END PIPE HEIGHT IS 345mm
- THE DIAMETER FO THE PIPE IS 22, THE WATER FLOW PIPE MS63 IS BRASS
- 360 ROTARY PIPE
- 40 BAR PRESSURE RESISTANT CERAMIC CARTRIDGE USED
- WATER FLOW IS BETWEEN 13 AND 18 PER MINUTE
- G 3/8 M-10 40 BAR PRESSURE RESISTANT STEEL BRAIDED FLEX USED

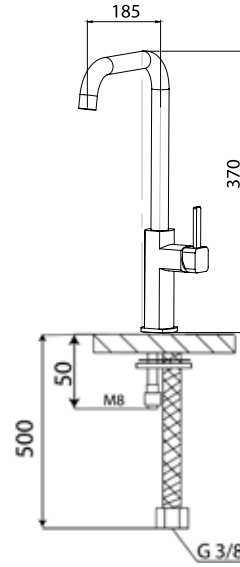

12 | 1.990,00 ₺

Code: 82 2018 0063

### Mix Kuğu Lavabo Bataryası

- ÜRÜNÜMÜZ MS58 PİRİNÇ MALZEMEDEN ÜRETİLMİŞTİR.
- YÜZEY KAPLAMASI 0,16 MİKRON KROM KAPLAMADIR.
- ÇIKIŞ UCU UZUNLUĞU 140 mm'DİR.
- ÇIKIŞ UCU YÜKSEKLİĞİ 270 mm'DİR.
- SU AKIŞ BORUSU ÇAPI 22mm, SU AKIŞ BORUSU MS63 PİRİNÇ.
- 360 DERECE DÖNER BORULUDUR.
- 40 BAR BASINCA DAYANIKLI SERAMİK KARTUŞ KULLANILMAKTADIR.
- PERLATÖRÜN SU AKIŞ DEBİSİ DAKİKADA 12 İLE 18 lt ARASINDADIR.
- 3/8 M-10 40 BAR BASINCA DAYANIKLI ÇELİK ÖRGÜLÜ FLEX KULLANILMIŞTIR.

### Mix Basin Faucet

- OUR PRODUCT IS MADE OF MS58 BRASS
- SURFACE COATING IS 0,16mm CHROME COATING
- OUTPUT LENGTH 140mm
- OUTPUT END PIPE HEIGHT IS 270mm
- THE DIAMETER FO THE PIPE IS 22, THE WATER FLOW PIPE MS63 IS BRASS
- 360 ROTARY PIPE
- 40 BAR PRESSURE RESISTANT CERAMIC CARTRIDGE USED
- WATER FLOW IS BETWEEN 13 AND 18 PER MINUTE
- G 3/8 M-10 40 BAR PRESSURE RESISTANT STEEL BRAIDED FLEX USED

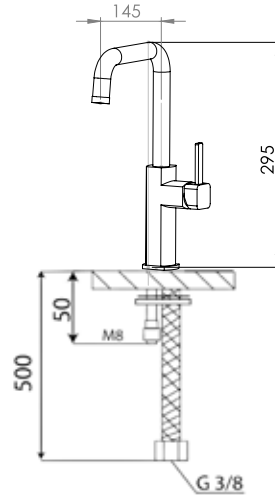

12 | 1.990,00 ₺

Code: 82 2018 0064

### Mix Sabit Lavabo Bataryası

- ÜRÜNÜMÜZ MS58/MS63 ORANINDA ALÇAK BASINÇ PİRİNÇ KÜLÇEDEN ÜRETİLMİŞTİR.
- YÜZEY KAPLAMASI 0,12 İLE 0,16 MİKRON KROM KAPLAMADIR.
- ÇIKIŞ UCU UZUNLUĞU 115 mm'DİR.
- ÜRÜN YÜKSEKLİĞİ 120 mm'DİR.
- 40 BAR BASINCA DAYANIKLI SERAMİK KARTUŞ KULLANILMAKTADIR.
- PERLATÖRÜN SU AKIŞ DEBİSİ DAKİKADA 19 İLE 23 lt ARASINDADIR.
- 3/8 M-10 40 BAR BASINCA DAYANIKLI ÇELİK ÖRGÜLÜ FLEX KULLANILMIŞTIR.

### Mix Basin Faucet

- OUR PRODUCT IS MADE OF MS58/MS63 BRASS LOW PRESSURE INGOTS
- SURFACE COATING IS 0,16mm CHROME COATING
- OUTPUT LENGTH 115 mm
- PRODUCT HEIGHT 120 mm
- 40 BAR PRESSURE RESISTANT CERAMIC CARTRIDGE USED
- WATER FLOW IS BETWEEN 19 AND 23 PER MINUTE
- G 3/8 M-10 40 BAR PRESSURE RESISTANT STEEL BRAIDED FLEX USED

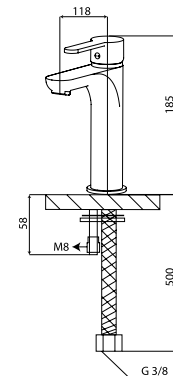

12 | 2.580,00 ₺

Code: 82 2018 0065



## Mix Banyo Bataryası

- ÜRÜNÜMÜZ MS58/MS63 ORANINDA ALÇAK BASINÇ PİRİNÇ KÜLÇEDEN ÜRETİLMİŞTİR.
- YÜZEY KAPLAMASI 0,12 İLE 0,16 MİKRON KROM KAPLAMADIR.
- ÇIKIŞ UCU UZUNLUĞU 175 mm'DİR.
- 40 BAR BASINCA DAYANIKLI SERAMİK KARTUŞ KULLANILMAKTADIR.
- PERLATÖRÜN SU AKIŞ DEBİSİ DAKİKADA 19 İLE 23 lt ARASINDADIR.
- YÖNLENDİRİCİ TAKIMI MS58 PİRİNÇTEN ÜRETİLMİŞTİR.
- TESİSAT BAĞLANTILARI G ½' DİR.
- EL DUŞU BAĞLANTISI G ½' DİR.

## Mix Bathroom Faucet

- OUR PRODUCT IS MADE OF MS58/MS63 BRASS LOW PRESSURE INGOTS
- SURFACE COATING IS 0,16mm CHROME COATING
- OUTPUT LENGTH 175mm
- 40 BAR PRESSURE RESISTANT CERAMIC CARTRIDGE USED
- WATER FLOW IS BETWEEN 19 AND 23 PER MINUTE
- THE ROYTER TOOLS WAS MADE BRASS'S
- INSTALLATION CONNECTIONS ARE G ½
- HAND SHOWER CONNECTIONS ARE G ½

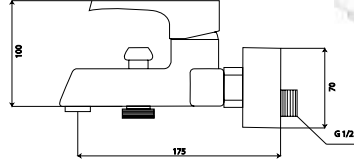

12 | 3.050,00 ₺

Code: 32 2010 3000



## Mix Kuğu Mutfak Bataryası

- ÜRÜNÜMÜZ MS58 PİRİNÇ MALZEMEDEN ÜRETİLMİŞTİR.
- YÜZEY KAPLAMASI 0,12 İLE 0,16 MİKRON KROM KAPLAMADIR.
- ÇIKIŞ UCU UZUNLUĞU 225 mm'DİR.
- ÇIKIŞ UCU YÜKSEKLİĞİ 310 mm'DİR.
- ÖZEL SU AKIŞ BORUSU, BORU MS58/MS63 ORANINDA ALÇAK BASINÇ PİRİNÇ KÜLÇEDEN ÜRETİLMİŞTİR.
- 360 DERECE DÖNER BORULUDUR.
- 40 BAR BASINCA DAYANIKLI SERAMİK KARTUŞ KULLANILMAKTADIR.
- PERLATÖRÜN SU AKIŞ DEBİSİ DAKİKADA 12 İLE 18 lt ARASINDADIR.
- 3/8 M-10 40 BAR BASINCA DAYANIKLI ÇELİK ÖRGÜLÜ FLEX KULLANILMIŞTIR.

## Mix Kitchen Faucet

- OUR PRODUCT IS MADE OF MS58 BRASS
- SURFACE COATING IS 0,16mm CHROME COATING
- OUTPUT LENGTH 225mm
- OUTPUT END PIPE HEIGHT IS 310mm
- SPECIAL WATER FLOW PIPE, OUR PRODUCT IS MADE OF MS58/MS63 BRASS LOW PRESSURE INGOTS
- 360 ROTARY PIPE
- 40 BAR PRESSURE RESISTANT CERAMIC CARTRIDGE USED
- WATER FLOW IS BETWEEN 13 AND 18 PER MINUTE
- G 3/8 M-10 40 BAR PRESSURE RESISTANT STEEL BRAIDED FLEX USED

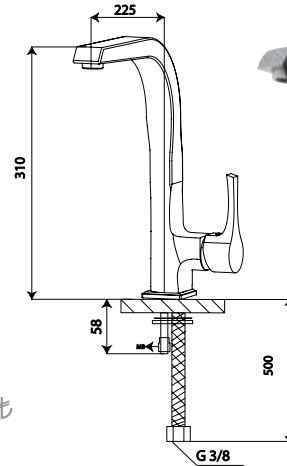

12 | 4.250,00 ₺

Code: 32 2010 3002



## Mix Lavabo Bataryası

- ÜRÜNÜMÜZ MS58/MS63 ORANINDA ALÇAK BASINÇ PİRİNÇ KÜLÇEDEN ÜRETİLMİŞTİR.
- YÜZEY KAPLAMASI 0,12 İLE 0,16 MİKRON KROM KAPLAMADIR.
- ÇIKIŞ UCU UZUNLUĞU 120 mm'DİR.
- ÜRÜN YÜKSEKLİĞİ 170 mm'DİR.
- 40 BAR BASINCA DAYANIKLI SERAMİK KARTUŞ KULLANILMAKTADIR.
- PERLATÖRÜN SU AKIŞ DEBİSİ DAKİKADA 19 İLE 23 lt ARASINDADIR.
- 3/8 M-10 40 BAR BASINCA DAYANIKLI ÇELİK ÖRGÜLÜ FLEX KULLANILMIŞTIR.

## Mix Basin Faucet

- OUR PRODUCT IS MADE OF MS58/MS63 BRASS LOW PRESSURE INGOTS
- SURFACE COATING IS 0,16mm CHROME COATING
- OUTPUT LENGTH 120 mm
- PRODUCT HEIGHT 170 mm
- 40 BAR PRESSURE RESISTANT CERAMIC CARTRIDGE USED
- WATER FLOW IS BETWEEN 19 AND 23 PER MINUTE
- G 3/8 M-10 40 BAR PRESSURE RESISTANT STEEL BRAIDED FLEX USED

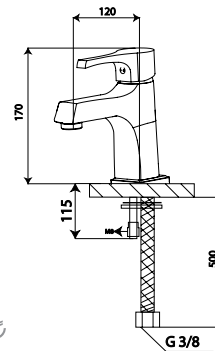

12 | 2.380,00 ₺

Code: 32 2010 3004



## MAT SİYAH SERİSİ

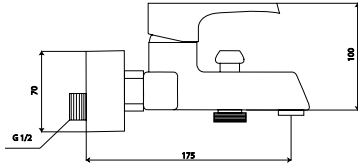

### Mix Banyo Bataryası

- ÜRÜNÜMÜZ MS58/MS63 ORANINDA ALÇAK BASINÇ PİRİNÇ KÜLÇEDEN ÜRETİLMİŞTİR.
- YÜZEY KAPLAMASI PULVER 916 BOYADIR.
- ÇIKIŞ UCU UZUNLUĞU 175 mm'DİR.
- 40 BAR BASINCA DAYANIKLI SERAMİK KARTUŞ KULLANILMAKTADIR.
- PERLATÖRÜN SU AKIŞ DEBİSİ DAKİKADA 19 İLE 23 lt ARASINDADIR.
- YÖNLENDİRİCİ TAKIMI MS58 PİRİNÇTEN ÜRETİLMİŞTİR.
- TESİSAT BAĞLANTILARI G ½' DİR.
- EL DUŞU BAĞLANTISI G ½' DİR.

### Mix Bathroom Faucet

- OUR PRODUCT IS MADE OF MS58/MS63 BRASS LOW PRESSURE INGOTS.
- SURFACE COATING IS PAINTED 916.
- OUTPUT LENGTH 175mm
- 40 BAR PRESSURE RESISTANT CERAMIC CARTRIDGE USED
- WATER FLOW IS BETWEEN 19 AND 23 PER MINUTE
- THE ROYTER TOOLS WAS MADE BRASS'S
- INSTALLATION CONNECTIONS ARE G ½
- HAND SHOWER CONNECTIONS ARE G ½

12 | 3.600,00 ₺

Code: 32 2010 3014

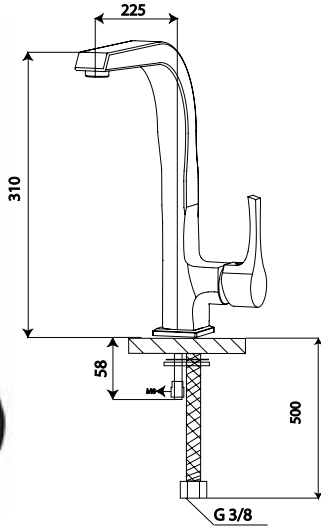

### Mix Mutfak Bataryası

- ÜRÜNÜMÜZ MS58 PİRİNÇ MALZEMEDEN ÜRETİLMİŞTİR.
- YÜZEY KAPLAMASI PULVER 916 BOYADIR.
- ÇIKIŞ UCU UZUNLUĞU 225mm'DİR.
- ÇIKIŞ UCU YÜKSEKLİĞİ 310 mm'DİR.
- ÖZEL SU AKIŞ BORUSU, BORU MS58/MS63 ORANINDA ALÇAK BASINÇ PİRİNÇ KÜLÇEDEN ÜRETİLMİŞTİR.
- 360 DERECE DÖNER BORULUDUR.
- 40 BAR BASINCA DAYANIKLI SERAMİK KARTUŞ KULLANILMAKTADIR.
- PERLATÖRÜN SU AKIŞ DEBİSİ DAKİKADA 12 İLE 18 lt ARASINDADIR.
- 3/8 M-10 40 BAR BASINCA DAYANIKLI ÇELİK ÖRGÜLÜ FLEX KULLANILMIŞTIR.

### Mix Kitchen Faucet

- OUR PRODUCT IS MADE OF MS58 BRASS.
- SURFACE COATING IS PAINTED 916.
- OUTPUT LENGTH 225mm
- OUTPUT END PIPE HEIGHT IS 310mm
- SPECIAL WATER FLOW PIPE, OUR PRODUCT IS MADE OF MS58/MS63 BRASS LOW PRESSURE INGOTS
- 360 ROTARY PIPE
- 40 BAR PRESSURE RESISTANT CERAMIC CARTRIDGE USED
- WATER FLOW IS BETWEEN 13 AND 18 PER MINUTE
- G 3/8 M-10 40 BAR PRESSURE RESISTANT STEEL BRAIDED FLEX USED

12 | 4.800,00 ₺

Code: 32 2010 3015

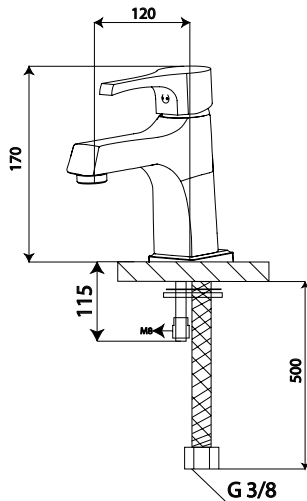

### Mix Lavabo Bataryası

- ÜRÜNÜMÜZ MS58/MS63 ORANINDA ALÇAK BASINÇ PİRİNÇ KÜLÇEDEN ÜRETİLMİŞTİR.
- YÜZEY KAPLAMASI PULVER 916 BOYADIR.
- ÇIKIŞ UCU UZUNLUĞU 120 mm'DİR.
- ÜRÜN YÜKSEKLİĞİ 170 mm'DİR.
- 40 BAR BASINCA DAYANIKLI SERAMİK KARTUŞ KULLANILMAKTADIR.
- PERLATÖRÜN SU AKIŞ DEBİSİ DAKİKADA 19 İLE 23 lt ARASINDADIR.
- 3/8 M-10 40 BAR BASINCA DAYANIKLI ÇELİK ÖRGÜLÜ FLEX KULLANILMIŞTIR.

### Mix Basin Faucet

- OUR PRODUCT IS MADE OF MS58/MS63 BRASS LOW PRESSURE INGOTS.
- SURFACE COATING IS PAINTED 916.
- OUTPUT LENGTH 120 mm
- PRODUCT HEIGHT 170 mm
- 40 BAR PRESSURE RESISTANT CERAMIC CARTRIDGE USED
- WATER FLOW IS BETWEEN 19 AND 23 PER MINUTE
- G 3/8 M-10 40 BAR PRESSURE RESISTANT STEEL BRAIDED FLEX USED

12 | 2.810,00 ₺

Code: 32 2010 3016

## ALTIN SERİSİ

Bu ürün 24 ayar altın kaplamadır

### Mix Banyo Bataryası

- ÜRÜNÜMÜZ MS58/MS63 ORANINDA ALÇAK BASINÇ PİRİNÇ KÜLÇEDEN ÜRETİLMİŞTİR.
- YÜZEY KAPLAMASI ÖZEL ALTIN BOYADIR.
- ÇIKIŞ UCU UZUNLUĞU 175 mm'DİR.
- 40 BAR BASINCA DAYANIKLI SERAMİK KARTUŞ KULLANILMAKTADIR.
- PERLATÖRÜN SU AKIŞ DEBİSİ DAKİKADA 19 İLE 23 lt ARASINDADIR.
- YÖNLENDİRİCİ TAKIMI MS58 PİRİNÇTEN ÜRETİLMİŞTİR.
- TESİSAT BAĞLANTILARI G ½' DİR.
- EL DUŞU BAĞLANTISI G ½' DİR.

### Mix Bathroom Faucet

- OUR PRODUCT IS MADE OF MS58/MS63 BRASS LOW PRESSURE INGOTS.
- SURFACE COATING IS SPECIAL GOLD PAINT.
- OUTPUT LENGTH 175mm
- 40 BAR PRESSURE RESISTANT CERAMIC CARTRIDGE USED
- WATER FLOW IS BETWEEN 19 AND 23 PER MINUTE
- THE ROYTER TOOLS WAS MADE BRASS'S
- INSTALLATION CONNECTIONS ARE G ½
- HAND SHOWER CONNECTIONS ARE G ½

12 | 4.450,00 ₺  
Code: 32 2010 3017

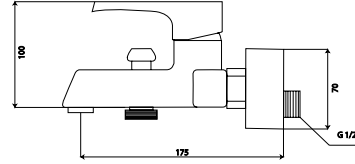

### Mix Mutfak Bataryası

- ÜRÜNÜMÜZ MS58 PİRİNÇ MALZEMEDEN ÜRETİLMİŞTİR.
- YÜZEY KAPLAMASI ÖZEL ALTIN BOYADIR.
- ÇIKIŞ UCU UZUNLUĞU 225mm'DİR.
- ÇIKIŞ UCU YÜKSEKLİĞİ 310 mm'DİR.
- ÖZEL SU AKIŞ BORUSU, BORU MS58/MS63 ORANINDA ALÇAK BASINÇ PİRİNÇ KÜLÇEDEN ÜRETİLMİŞTİR.
- 360 DERECE DÖNER BORULUDUR.
- 40 BAR BASINCA DAYANIKLI SERAMİK KARTUŞ KULLANILMAKTADIR.
- PERLATÖRÜN SU AKIŞ DEBİSİ DAKİKADA 12 İLE 18 lt ARASINDADIR.
- 3/8 M-10 40 BAR BASINCA DAYANIKLI ÇELİK ÖRGÜLÜ FLEX KULLANILMIŞTIR.

### Mix Kitchen Faucet

- OUR PRODUCT IS MADE OF MS58 BRASS.
- SURFACE COATING IS SPECIAL GOLD PAINT.
- OUTPUT LENGTH 225mm
- OUTPUT END PIPE HEIGHT IS 310mm
- SPECIAL WATER FLOW PIPE, OUR PRODUCT IS MADE OF MS58/MS63 BRASS LOW PRESSURE INGOTS
- 360 ROTARY PIPE
- 40 BAR PRESSURE RESISTANT CERAMIC CARTRIDGE USED
- WATER FLOW IS BETWEEN 13 AND 18 PER MINUTE
- G 3/8 M-10 40 BAR PRESSURE RESISTANT STEEL BRAIDED FLEX USED

12 | 5.600,00 ₺  
Code: 32 2010 3018

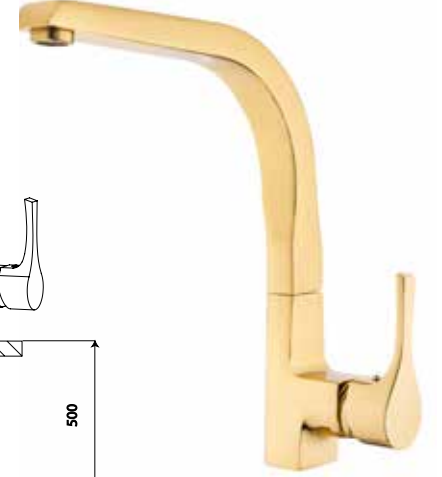
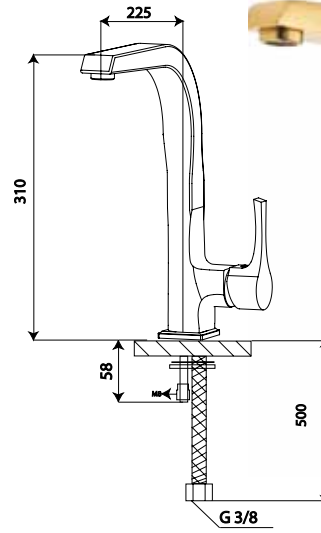

### Mix Lavabo Bataryası

- ÜRÜNÜMÜZ MS58/MS63 ORANINDA ALÇAK BASINÇ PİRİNÇ KÜLÇEDEN ÜRETİLMİŞTİR.
- YÜZEY KAPLAMASI ÖZEL ALTIN BOYADIR.
- ÇIKIŞ UCU UZUNLUĞU 120 mm'DİR.
- ÜRÜN YÜKSEKLİĞİ 170 mm'DİR.
- 40 BAR BASINCA DAYANIKLI SERAMİK KARTUŞ KULLANILMAKTADIR.
- PERLATÖRÜN SU AKIŞ DEBİSİ DAKİKADA 19 İLE 23 lt ARASINDADIR.
- 3/8 M-10 40 BAR BASINCA DAYANIKLI ÇELİK ÖRGÜLÜ FLEX KULLANILMIŞTIR.

### Mix Basin Faucet

- OUR PRODUCT IS MADE OF MS58/MS63 BRASS LOW PRESSURE INGOTS
- SURFACE COATING IS SPECIAL GOLD PAINT.
- OUTPUT LENGTH 120 mm
- PRODUCT HEIGHT 170 mm
- 40 BAR PRESSURE RESISTANT CERAMIC CARTRIDGE USED
- WATER FLOW IS BETWEEN 19 AND 23 PER MINUTE
- G 3/8 M-10 40 BAR PRESSURE RESISTANT STEEL BRAIDED FLEX USED

12 | 3.600,00 ₺  
Code: 32 2010 3019

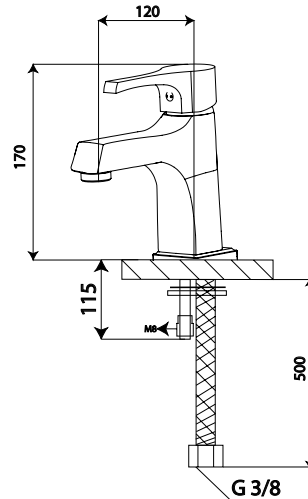

KROM

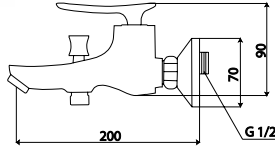

**Mix Banyo Bataryası**

- ÜRÜNÜMÜZ MS58/MS63 ORANINDA ALÇAK BASINÇ PİRİNÇ KÜLÇEDEN ÜRETİLMİŞTİR.
- YÜZEY KAPLAMASI PULVER 916 BOYADIR.
- ÇIKIŞ UCU UZUNLUĞU 200 mm'DİR.
- 40 BAR BASINCA DAYANIKLI SERAMİK KARTUŞ KULLANILMAKTADIR.
- PERLATÖRÜN SU AKIŞ DEBİSİ DAKİKADA 19 İLE 23 lt ARASINDADIR.
- YÖNLENDİRİCİ TAKIMI MS58 PİRİNÇTEN ÜRETİLMİŞTİR.
- TESİSAT BAĞLANTILARI G ½' DİR.
- EL DUŞU BAĞLANTISI G ½' DİR.

**Mix Bathroom Faucet**

- OUR PRODUCT IS MADE OF MS58/MS63 BRASS LOW PRESSURE INGOTS
- SURFACE COATING IS PAINTED 916.
- OUTPUT LENGTH 200mm
- 40 BAR PRESSURE RESISTANT CERAMIC CARTRIDGE USED
- WATER FLOW IS BETWEEN 19 AND 23 PER MINUTE
- THE ROYTER TOOLS WAS MADE BRASS'S
- INSTALLATION CONNECTIONS ARE G ½
- HAND SHOWER CONNECTIONS ARE G ½

4 | 3.600,00 ₺  
Code: 32 2010 0327

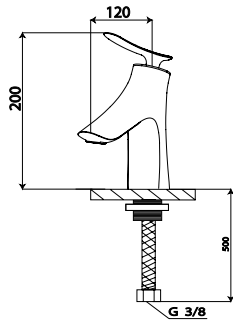

**Mix Lavabo Bataryası**

- ÜRÜNÜMÜZ MS58/MS63 ORANINDA ALÇAK BASINÇ PİRİNÇ KÜLÇEDEN ÜRETİLMİŞTİR.
- YÜZEY KAPLAMASI PULVER 916 BOYADIR.
- ÇIKIŞ UCU UZUNLUĞU 120 mm'DİR.
- ÜRÜN YÜKSEKLİĞİ 200 mm'DİR.
- 40 BAR BASINCA DAYANIKLI SERAMİK KARTUŞ KULLANILMAKTADIR.
- PERLATÖRÜN SU AKIŞ DEBİSİ DAKİKADA 19 İLE 23 lt ARASINDADIR.
- 3/8 M-10 40 BAR BASINCA DAYANIKLI ÇELİK ÖRGÜLÜ FLEX KULLANILMIŞTIR.

**Mix Basin Faucet**

- OUR PRODUCT IS MADE OF MS58/MS63 BRASS LOW PRESSURE INGOTS
- SURFACE COATING IS PAINTED 916.
- OUTPUT LENGTH 120 mm
- PRODUCT HEIGHT 200 mm
- 40 BAR PRESSURE RESISTANT CERAMIC CARTRIDGE USED
- WATER FLOW IS BETWEEN 19 AND 23 PER MINUTE
- G 3/8 M-10 40 BAR PRESSURE RESISTANT STEEL BRAIDED FLEX USED

4 | 3.450,00 ₺  
Code: 32 2010 0328

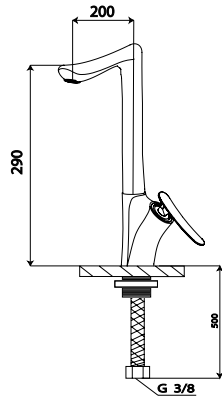

**Mix Kuğu Mutfak Bataryası**

- ÜRÜNÜMÜZ MS58 PİRİNÇ MALZEMEDEN ÜRETİLMİŞTİR.
- YÜZEY KAPLAMASI PULVER 916 BOYADIR.
- ÇIKIŞ UCU UZUNLUĞU 185 mm'DİR.
- ÇIKIŞ UCU YÜKSEKLİĞİ 280 mm'DİR.
- SU AKIŞ BORUSU ÇAPI 22mm, SU AKIŞ BORUSU MS63 PİRİNÇTİR.
- 360 DERECE DÖNER BORULUDUR.
- 40 BAR BASINCA DAYANIKLI SERAMİK KARTUŞ KULLANILMAKTADIR.
- PERLATÖRÜN SU AKIŞ DEBİSİ DAKİKADA 12 İLE 18 lt ARASINDADIR.
- 3/8 M-10 40 BAR BASINCA DAYANIKLI ÇELİK ÖRGÜLÜ FLEX KULLANILMIŞTIR.

**Mix Swan Kitchen Faucet**

- OUR PRODUCT IS MADE OF MS58 BRASS.
- SURFACE COATING IS PAINTED 916.
- OUTPUT LENGTH 225mm
- OUTPUT END PIPE HEIGHT IS 310mm
- SPECIAL WATER FLOW PIPE, OUR PRODUCT IS MADE OF MS58/MS63 BRASS LOW PRESSURE INGOTS
- 360 ROTARY PIPE
- 40 BAR PRESSURE RESISTANT CERAMIC CARTRIDGE USED
- WATER FLOW IS BETWEEN 13 AND 18 PER MINUTE
- G 3/8 M-10 40 BAR PRESSURE RESISTANT STEEL BRAIDED FLEX USED

4 | 5.020,00 ₺  
Code: 32 2010 0329

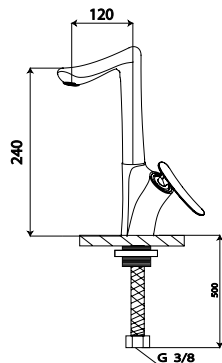

**Mix Kuğu Lavabo Bataryası**

- ÜRÜNÜMÜZ MS58 PİRİNÇ MALZEMEDEN ÜRETİLMİŞTİR.
- YÜZEY KAPLAMASI PULVER 916 BOYADIR.
- ÇIKIŞ UCU UZUNLUĞU 120mm'DİR.
- ÇIKIŞ UCU YÜKSEKLİĞİ 240mm'DİR.
- ÖZEL SU AKIŞ BORUSU, BORU MS58/MS63 ORANINDA ALÇAK BASINÇ PİRİNÇ KÜLÇEDEN ÜRETİLMİŞTİR.
- 360 DERECE DÖNER BORULUDUR.
- 40 BAR BASINCA DAYANIKLI SERAMİK KARTUŞ KULLANILMAKTADIR.
- PERLATÖRÜN SU AKIŞ DEBİSİ DAKİKADA 12 İLE 18 lt ARASINDADIR.
- 3/8 M-10 40 BAR BASINCA DAYANIKLI ÇELİK ÖRGÜLÜ FLEX KULLANILMIŞTIR.

**Mix Swan Basin Faucet**

- OUR PRODUCT IS MADE OF MS58 BRASS
- SURFACE COATING IS PAINTED 916.
- OUTPUT LENGTH 120mm
- OUTPUT END PIPE HEIGHT IS 240mm
- SPECIAL WATER FLOW PIPE, OUR PRODUCT IS MADE OF MS58/MS63 BRASS LOW PRESSURE INGOTS
- 360 ROTARY PIPE
- 40 BAR PRESSURE RESISTANT CERAMIC CARTRIDGE USED
- WATER FLOW IS BETWEEN 13 AND 18 PER MINUTE
- G 3/8 M-10 40 BAR PRESSURE RESISTANT STEEL BRAIDED FLEX USED

4 | 4.010,00 ₺  
Code: 32 2010 0330



**Mix Banyo Bataryası**

- ÜRÜNÜMÜZ MS58/MS63 ORANINDA ALÇAK BASINÇ PİRİNÇ KÜLÇEDEN ÜRETİLMİŞTİR.
- YÜZEY KAPLAMASI 0,12 İLE 0,16 MİKRON KROM KAPLAMADIR.
- ÇIKIŞ UCU UZUNLUĞU 200 mm'DİR.
- 40 BAR BASINCA DAYANIKLI SERAMİK KARTUŞ KULLANILMAKTADIR.
- PERLATÖRÜN SU AKIŞ DEBİSİ DAKİKADA 19 İLE 23 lt ARASINDADIR.
- YÖNLENDİRİCİ TAKIMI MS58 PİRİNÇTEN ÜRETİLMİŞTİR.
- TESİSAT BAĞLANTILARI G ½' DİR.
- EL DUŞU BAĞLANTISI G ½' DİR.

**Mix Bathroom Faucet**

- OUR PRODUCT IS MADE OF MS58/MS63 BRASS LOW PRESSURE INGOTS
- SURFACE COATING IS 0,16mm CHROME COATING
- OUTPUT LENGTH 200mm
- 40 BAR PRESSURE RESISTANT CERAMIC CARTRIDGE USED
- WATER FLOW IS BETWEEN 19 AND 23 PER MINUTE
- THE ROYTER TOOLS WAS MADE BRASS'S
- INSTALLATION CONNECTIONS ARE G ½
- HAND SHOWER CONNECTIONS ARE G ½

12 | 4.260,00 ₺  
Code: 32 2010 0355

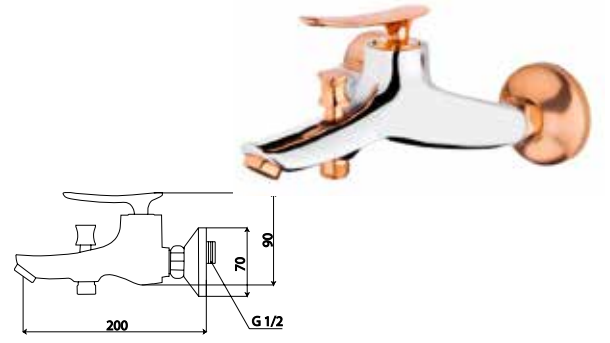

KROM &amp; ROSS

**Mix Lavabo Bataryası**

- ÜRÜNÜMÜZ MS58/MS63 ORANINDA ALÇAK BASINÇ PİRİNÇ KÜLÇEDEN ÜRETİLMİŞTİR.
- YÜZEY KAPLAMASI 0,12 İLE 0,16 MİKRON KROM KAPLAMADIR.
- ÇIKIŞ UCU UZUNLUĞU 120 mm'DİR.
- ÜRÜN YÜKSEKLİĞİ 200 mm'DİR.
- 40 BAR BASINCA DAYANIKLI SERAMİK KARTUŞ KULLANILMAKTADIR.
- PERLATÖRÜN SU AKIŞ DEBİSİ DAKİKADA 19 İLE 23 lt ARASINDADIR.
- 3/8 M-10 40 BAR BASINCA DAYANIKLI ÇELİK ÖRGÜLÜ FLEX KULLANILMIŞTIR.

**Mix Basin Faucet**

- OUR PRODUCT IS MADE OF MS58/MS63 BRASS LOW PRESSURE INGOTS
- SURFACE COATING IS 0,16mm CHROME COATING
- OUTPUT LENGTH 120 mm
- PRODUCT HEIGHT 200 mm
- 40 BAR PRESSURE RESISTANT CERAMIC CARTRIDGE USED
- WATER FLOW IS BETWEEN 19 AND 23 PER MINUTE
- G 3/8 M-10 40 BAR PRESSURE RESISTANT STEEL BRAIDED FLEX USED

12 | 3.900,00 ₺  
Code: 32 2010 0356

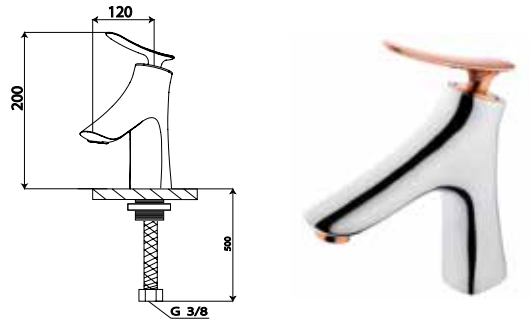
**Mix Kuğu Mutfak Bataryası**

- ÜRÜNÜMÜZ MS58 PİRİNÇ MALZEMEDEN ÜRETİLMİŞTİR.
- YÜZEY KAPLAMASI 0,12 İLE 0,16 MİKRON KROM KAPLAMADIR.
- ÇIKIŞ UCU UZUNLUĞU 185 mm'DİR.
- ÇIKIŞ UCU YÜKSEKLİĞİ 280 mm'DİR.
- SU AKIŞ BORUSU ÇAP 22mm, SU AKIŞ BORUSU MS63 PİRİNÇTİR.
- 360 DERECE DÖNER BORULUDUR.
- 40 BAR BASINCA DAYANIKLI SERAMİK KARTUŞ KULLANILMAKTADIR.
- PERLATÖRÜN SU AKIŞ DEBİSİ DAKİKADA 12 İLE 18 lt ARASINDADIR.
- 3/8 M-10 40 BAR BASINCA DAYANIKLI ÇELİK ÖRGÜLÜ FLEX KULLANILMIŞTIR.

**Mix Swan Kitchen Faucet**

- OUR PRODUCT IS MADE OF MS58 BRASS
- SURFACE COATING IS 0,16mm CHROME COATING
- OUTPUT LENGTH 185mm
- OUTPUT END PIPE HEIGHT IS 280mm
- SPECIAL WATER FLOW PIPE, OUR PRODUCT IS MADE OF MS58/MS63 BRASS LOW PRESSURE INGOTS
- 360 ROTARY PIPE
- 40 BAR PRESSURE RESISTANT CERAMIC CARTRIDGE USED
- WATER FLOW IS BETWEEN 12 AND 18 PER MINUTE
- G 3/8 M-10 40 BAR PRESSURE RESISTANT STEEL BRAIDED FLEX USED

12 | 5.750,00 ₺  
Code: 32 2010 0357

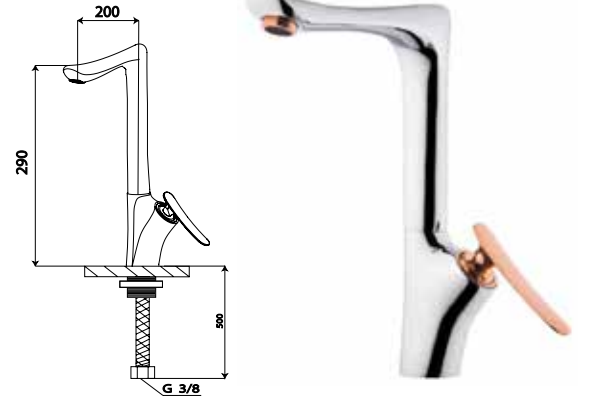
**Mix Kuğu Lavabo Bataryası**

- ÜRÜNÜMÜZ MS58 PİRİNÇ MALZEMEDEN ÜRETİLMİŞTİR.
- YÜZEY KAPLAMASI 0,12 İLE 0,16 MİKRON KROM KAPLAMADIR.
- ÇIKIŞ UCU UZUNLUĞU 120mm'DİR.
- ÇIKIŞ UCU YÜKSEKLİĞİ 240mm'DİR.
- ÖZEL SU AKIŞ BORUSU, BORU MS58/MS63 ORANINDA ALÇAK BASINÇ PİRİNÇ KÜLÇEDEN ÜRETİLMİŞTİR.
- 360 DERECE DÖNER BORULUDUR.
- 40 BAR BASINCA DAYANIKLI SERAMİK KARTUŞ KULLANILMAKTADIR.
- PERLATÖRÜN SU AKIŞ DEBİSİ DAKİKADA 12 İLE 18 lt ARASINDADIR.
- 3/8 M-10 40 BAR BASINCA DAYANIKLI ÇELİK ÖRGÜLÜ FLEX KULLANILMIŞTIR.

**Mix Swan Basin Faucet**

- OUR PRODUCT IS MADE OF MS58 BRASS
- SURFACE COATING IS 0,16mm CHROME COATING
- OUTPUT LENGTH 120mm
- OUTPUT END PIPE HEIGHT IS 240mm
- SPECIAL WATER FLOW PIPE, OUR PRODUCT IS MADE OF MS58/MS63 BRASS LOW PRESSURE INGOTS
- 360 ROTARY PIPE
- 40 BAR PRESSURE RESISTANT CERAMIC CARTRIDGE USED
- WATER FLOW IS BETWEEN 13 AND 18 PER MINUTE
- G 3/8 M-10 40 BAR PRESSURE RESISTANT STEEL BRAIDED FLEX USED

12 | 4.600,00 ₺  
Code: 32 2010 0358

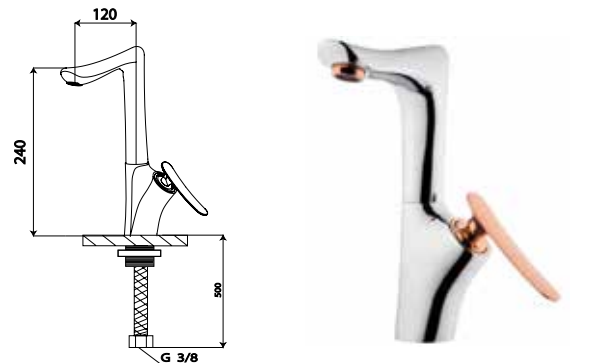

## İNCİ SİYAH & GOLD

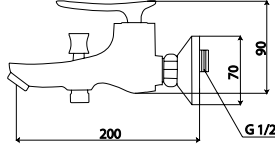

### Mix Banyo Bataryası

- ÜRÜNÜMÜZ MS58/MS63 ORANINDA ALÇAK BASINÇ PİRİNÇ KÜLÇEDEN ÜRETİLMİŞTİR.
- YÜZEY KAPLAMASI PULVER 916 BOYADIR.
- ÇIKIŞ UCU UZUNLUĞU 200 mm'DİR.
- 40 BAR BASINCA DAYANIKLI SERAMİK KARTUŞ KULLANILMAKTADIR.
- PERLATÖRÜN SU AKIŞ DEBİSİ DAKİKADA 19 İLE 23 lt ARASINDADIR.
- YÖNLENDİRİCİ TAKIMI MS58 PİRİNÇTEN ÜRETİLMİŞTİR.
- TESİSAT BAĞLANTILARI G ½' DİR.
- EL DUŞU BAĞLANTISI G ½' DİR.

### Mix Bathroom Faucet

- OUR PRODUCT IS MADE OF MS58/MS63 BRASS LOW PRESSURE INGOTS
- SURFACE COATING IS PAINTED 916.
- OUTPUT LENGTH 200mm
- 40 BAR PRESSURE RESISTANT CERAMIC CARTRIDGE USED
- WATER FLOW IS BETWEEN 19 AND 23 PER MINUTE
- THE ROYTER TOOLS WAS MADE BRASS'S
- INSTALLATION CONNECTIONS ARE G ½
- HAND SHOWER CONNECTIONS ARE G ½

4 | 5.400,00 ₺  
Code: 32 2010 0339

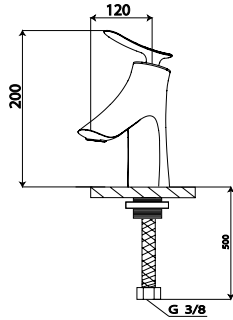

### Mix Lavabo Bataryası

- ÜRÜNÜMÜZ MS58/MS63 ORANINDA ALÇAK BASINÇ PİRİNÇ KÜLÇEDEN ÜRETİLMİŞTİR.
- YÜZEY KAPLAMASI PULVER 916 BOYADIR.
- ÇIKIŞ UCU UZUNLUĞU 120 mm'DİR.
- ÜRÜN YÜKSEKLİĞİ 200 mm'DİR.
- 40 BAR BASINCA DAYANIKLI SERAMİK KARTUŞ KULLANILMAKTADIR.
- PERLATÖRÜN SU AKIŞ DEBİSİ DAKİKADA 19 İLE 23 lt ARASINDADIR.
- 3/8 M-10 40 BAR BASINCA DAYANIKLI ÇELİK ÖRGÜLÜ FLEX KULLANILMIŞTIR.

### Mix Basın Faucet

- OUR PRODUCT IS MADE OF MS58/MS63 BRASS LOW PRESSURE INGOTS
- SURFACE COATING IS PAINTED 916.
- OUTPUT LENGTH 120 mm
- PRODUCT HEIGHT 200 mm
- 40 BAR PRESSURE RESISTANT CERAMIC CARTRIDGE USED
- WATER FLOW IS BETWEEN 19 AND 23 PER MINUTE
- G 3/8 M-10 40 BAR PRESSURE RESISTANT STEEL BRAIDED FLEX USED

4 | 5.240,00 ₺  
Code: 32 2010 0340

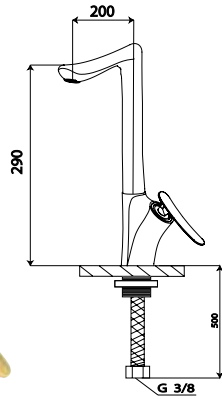

### Mix Kuğu Mutfak Bataryası

- ÜRÜNÜMÜZ MS58 PİRİNÇ MALZEMEDEN ÜRETİLMİŞTİR.
- YÜZEY KAPLAMASI PULVER 916 BOYADIR.
- ÇIKIŞ UCU UZUNLUĞU 185 mm'DİR.
- ÇIKIŞ UCU YÜKSEKLİĞİ 280 mm'DİR.
- SU AKIŞ BORUSU ÇAPI 22mm, SU AKIŞ BORUSU MS63 PİRİNÇTİR.
- 360 DERECE DÖNER BORULUDUR.
- 40 BAR BASINCA DAYANIKLI SERAMİK KARTUŞ KULLANILMAKTADIR.
- PERLATÖRÜN SU AKIŞ DEBİSİ DAKİKADA 12 İLE 18 lt ARASINDADIR.
- 3/8 M-10 40 BAR BASINCA DAYANIKLI ÇELİK ÖRGÜLÜ FLEX KULLANILMIŞTIR.

### Mix Swan Kitchen Faucet

- OUR PRODUCT IS MADE OF MS58 BRASS.
- SURFACE COATING IS PAINTED 916.
- OUTPUT LENGTH 225mm
- OUTPUT END PIPE HEIGHT IS 310mm
- SPECIAL WATER FLOW PIPE, OUR PRODUCT IS MADE OF MS58/MS63 BRASS LOW PRESSURE INGOTS
- 360 ROTARY PIPE
- 40 BAR PRESSURE RESISTANT CERAMIC CARTRIDGE USED
- WATER FLOW IS BETWEEN 13 AND 18 PER MINUTE
- G 3/8 M-10 40 BAR PRESSURE RESISTANT STEEL BRAIDED FLEX USED

4 | 6.950,00 ₺  
Code: 32 2010 0342

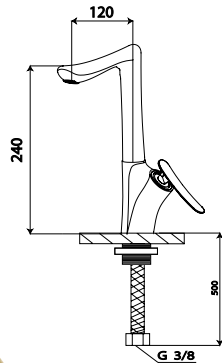

### Mix Kuğu Lavabo Bataryası

- ÜRÜNÜMÜZ MS58 PİRİNÇ MALZEMEDEN ÜRETİLMİŞTİR.
- YÜZEY KAPLAMASI PULVER 916 BOYADIR.
- ÇIKIŞ UCU UZUNLUĞU 120mm'DİR.
- ÇIKIŞ UCU YÜKSEKLİĞİ 240mm'DİR.
- ÖZEL SU AKIŞ BORUSU, BORU MS58/MS63 ORANINDA ALÇAK BASINÇ PİRİNÇ KÜLÇEDEN ÜRETİLMİŞTİR.
- 360 DERECE DÖNER BORULUDUR.
- 40 BAR BASINCA DAYANIKLI SERAMİK KARTUŞ KULLANILMAKTADIR.
- PERLATÖRÜN SU AKIŞ DEBİSİ DAKİKADA 12 İLE 18 lt ARASINDADIR.
- 3/8 M-10 40 BAR BASINCA DAYANIKLI ÇELİK ÖRGÜLÜ FLEX KULLANILMIŞTIR.

### Mix Swan Basın Faucet

- OUR PRODUCT IS MADE OF MS58 BRASS
- SURFACE COATING IS PAINTED 916.
- OUTPUT LENGTH 120mm
- OUTPUT END PIPE HEIGHT IS 240mm
- SPECIAL WATER FLOW PIPE, OUR PRODUCT IS MADE OF MS58/MS63 BRASS LOW PRESSURE INGOTS
- 360 ROTARY PIPE
- 40 BAR PRESSURE RESISTANT CERAMIC CARTRIDGE USED
- WATER FLOW IS BETWEEN 13 AND 18 PER MINUTE
- G 3/8 M-10 40 BAR PRESSURE RESISTANT STEEL BRAIDED FLEX USED

4 | 6.360,00 ₺  
Code: 32 2010 0341

## Mix Banyo Bataryası

- ÜRÜNÜMÜZ MS58/MS63 ORANINDA ALÇAK BASINÇ PİRİNÇ KÜLÇEDEN ÜRETİLMİŞTİR.
- YÜZEY KAPLAMASI PULVER 916 BOYADIR.
- ÇIKIŞ UCU UZUNLUĞU 200 mm'DİR.
- 40 BAR BASINCA DAYANIKLI SERAMİK KARTUŞ KULLANILMAKTADIR.
- PERLATÖRÜN SU AKIŞ DEBİSİ DAKİKADA19 İLE 23 lt ARASINDADIR.
- YÖNLENDİRİCİ TAKIMI MS58 PİRİNÇTEN ÜRETİLMİŞTİR.
- TESİSAT BAĞLANTILARI G ½' DİR.
- EL DUŞU BAĞLANTISI G ½' DİR.

## Mix Bathroom Faucet

- OUR PRODUCT IS MADE OF MS58/MS63 BRASS LOW PRESSURE INGOTS
- SURFACE COATING IS PAINTED 916.
- OUTPUT LENGTH 200mm
- 40 BAR PRESSURE RESISTANT CERAMIC CARTRIDGE USED
- WATER FLOW IS BETWEEN 19 AND 23 PER MINUTE
- THE ROYTER TOOLS WAS MADE BRASS'S
- INSTALLATION CONNECTIONS ARE G ½
- HAND SHOWER CONNECTIONS ARE G ½

4 | 5.400,00₺

Code: 32 2010 0343

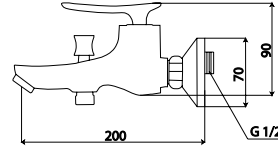

**GOLD**  
Bu ürün 24 ayar altın kaplamadır



## Mix Lavabo Bataryası

- ÜRÜNÜMÜZ MS58/MS63 ORANINDA ALÇAK BASINÇ PİRİNÇ KÜLÇEDEN ÜRETİLMİŞTİR.
- YÜZEY KAPLAMASI PULVER 916 BOYADIR.
- ÇIKIŞ UCU UZUNLUĞU 120 mm'DİR.
- ÜRÜN YÜKSEKLİĞİ 200 mm'DİR.
- 40 BAR BASINCA DAYANIKLI SERAMİK KARTUŞ KULLANILMAKTADIR.
- PERLATÖRÜN SU AKIŞ DEBİSİ DAKİKADA19 İLE 23 lt ARASINDADIR.
- 3/8 M-10 40 BAR BASINCA DAYANIKLI ÇELİK ÖRGÜLÜ FLEX KULLANILMIŞTIR.

## Mix Basin Faucet

- OUR PRODUCT IS MADE OF MS58/MS63 BRASS LOW PRESSURE INGOTS
- SURFACE COATING IS PAINTED 916.
- OUTPUT LENGTH 120 mm
- PRODUCT HEIGHT 200 mm
- 40 BAR PRESSURE RESISTANT CERAMIC CARTRIDGE USED
- WATER FLOW IS BETWEEN 19 AND 23 PER MINUTE
- G 3/8 M-10 40 BAR PRESSURE RESISTANT STEEL BRAIDED FLEX USED

4 | 5.240,00₺

Code: 32 2010 0344

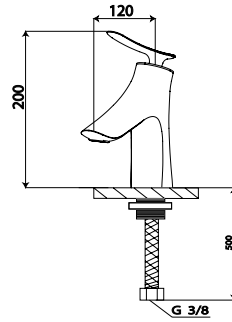

## Mix Kuğu Mutfak Bataryası

- ÜRÜNÜMÜZ MS58 PİRİNÇ MALZEMEDEN ÜRETİLMİŞTİR.
- YÜZEY KAPLAMASI PULVER 916 BOYADIR.
- ÇIKIŞ UCU UZUNLUĞU 185 mm'DİR.
- ÇIKIŞ UCU YÜKSEKLİĞİ 280 mm'DİR.
- SU AKIŞ BORUSU ÇAPı 22mm, SU AKIŞ BORUSU MS63 PİRİNÇTİR.
- 360 DERECE DÖNER BORULUDUR.
- 40 BAR BASINCA DAYANIKLI SERAMİK KARTUŞ KULLANILMAKTADIR.
- PERLATÖRÜN SU AKIŞ DEBİSİ DAKİKADA12 İLE 18 lt ARASINDADIR.
- 3/8 M-10 40 BAR BASINCA DAYANIKLI ÇELİK ÖRGÜLÜ FLEX KULLANILMIŞTIR.

## Mix Swan Kitchen Faucet

- OUR PRODUCT IS MADE OF MS58 BRASS.
- SURFACE COATING IS PAINTED 916.
- OUTPUT LENGTH 225mm
- OUTPUT END PIPE HEIGHT IS 310mm
- SPECIAL WATER FLOW PIPE, OUR PRODUCT IS MADE OF MS58/MS63 BRASS LOW PRESSURE INGOTS
- 360 ROTARY PIPE
- 40 BAR PRESSURE RESISTANT CERAMIC CARTRIDGE USED
- WATER FLOW IS BETWEEN 13 AND 18 PER MINUTE
- G 3/8 M-10 40 BAR PRESSURE RESISTANT STEEL BRAIDED FLEX USED

4 | 6.950,00₺

Code: 32 2010 0346

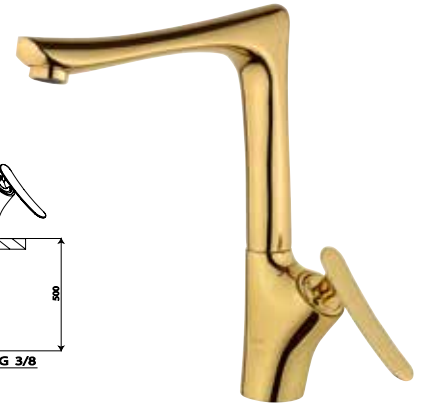
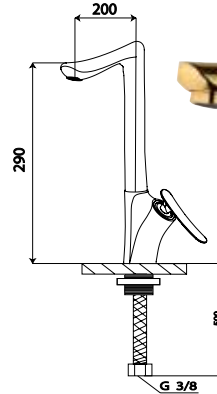

## Mix Kuğu Lavabo Bataryası

- ÜRÜNÜMÜZ MS58 PİRİNÇ MALZEMEDEN ÜRETİLMİŞTİR.
- YÜZEY KAPLAMASI PULVER 916 BOYADIR.
- ÇIKIŞ UCU UZUNLUĞU 120mm'DİR.
- ÇIKIŞ UCU YÜKSEKLİĞİ 240mm'DİR.
- ÖZEL SU AKIŞ BORUSU, BORU MS58/MS63 ORANINDA ALÇAK BASINÇ PİRİNÇ KÜLÇEDEN ÜRETİLMİŞTİR.
- 360 DERECE DÖNER BORULUDUR.
- 40 BAR BASINCA DAYANIKLI SERAMİK KARTUŞ KULLANILMAKTADIR.
- PERLATÖRÜN SU AKIŞ DEBİSİ DAKİKADA12 İLE 18 lt ARASINDADIR.
- 3/8 M-10 40 BAR BASINCA DAYANIKLI ÇELİK ÖRGÜLÜ FLEX KULLANILMIŞTIR.

## Mix Swan Basin Faucet

- OUR PRODUCT IS MADE OF MS58 BRASS
- SURFACE COATING IS PAINTED 916.
- OUTPUT LENGTH 120mm
- OUTPUT END PIPE HEIGHT IS 240mm
- SPECIAL WATER FLOW PIPE, OUR PRODUCT IS MADE OF MS58/MS63 BRASS LOW PRESSURE INGOTS
- 360 ROTARY PIPE
- 40 BAR PRESSURE RESISTANT CERAMIC CARTRIDGE USED
- WATER FLOW IS BETWEEN 13 AND 18 PER MINUTE
- G 3/8 M-10 40 BAR PRESSURE RESISTANT STEEL BRAIDED FLEX USED

4 | 6.360,00₺

Code: 32 2010 0345

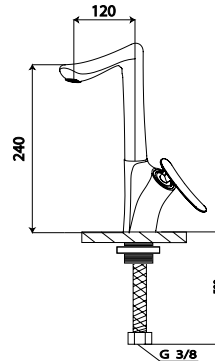

## MAT SİYAH & ROSS

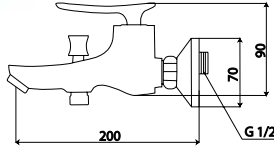

### Mix Banyo Bataryası

- ÜRÜNÜMÜZ MS58/MS63 ORANINDA ALÇAK BASINÇ PİRİNÇ KÜLÇEDEN ÜRETİLMİŞTİR.
- YÜZEY KAPLAMASI PULVER 916 BOYADIR.
- ÇIKIŞ UCU UZUNLUĞU 200 mm'DİR.
- 40 BAR BASINCA DAYANIKLI SERAMİK KARTUŞ KULLANILMAKTADIR.
- PERLATÖRÜN SU AKIŞ DEBİSİ DAKİKADA 19 İLE 23 lt ARASINDADIR.
- YÖNLENDİRİCİ TAKIMI MS58 PİRİNÇTEN ÜRETİLMİŞTİR.
- TESİSAT BAĞLANTILARI G 1/2' DİR.
- EL DUŞU BAĞLANTISI G 1/2' DİR.

### Mix Bathroom Faucet

- OUR PRODUCT IS MADE OF MS58/MS63 BRASS LOW PRESSURE INGOTS
- SURFACE COATING IS PAINTED 916.
- OUTPUT LENGTH 200mm
- 40 BAR PRESSURE RESISTANT CERAMIC CARTRIDGE USED
- WATER FLOW IS BETWEEN 19 AND 23 PER MINUTE
- THE ROYTER TOOLS WAS MADE BRASS'S
- INSTALLATION CONNECTIONS ARE G 1/2
- HAND SHOWER CONNECTIONS ARE G 1/2

4 | 4.750,00 ₺  
Code: 32 2010 0359

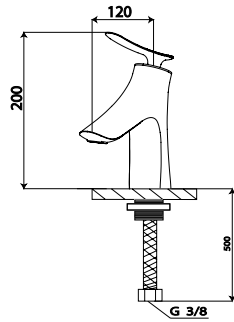

### Mix Lavabo Bataryası

- ÜRÜNÜMÜZ MS58/MS63 ORANINDA ALÇAK BASINÇ PİRİNÇ KÜLÇEDEN ÜRETİLMİŞTİR.
- YÜZEY KAPLAMASI PULVER 916 BOYADIR.
- ÇIKIŞ UCU UZUNLUĞU 120 mm'DİR.
- ÜRÜN YÜKSEKLİĞİ 200 mm'DİR.
- 40 BAR BASINCA DAYANIKLI SERAMİK KARTUŞ KULLANILMAKTADIR.
- PERLATÖRÜN SU AKIŞ DEBİSİ DAKİKADA 19 İLE 23 lt ARASINDADIR.
- 3/8 M-10 40 BAR BASINCA DAYANIKLI ÇELİK ÖRGÜLÜ FLEX KULLANILMIŞTIR.

### Mix Basın Faucet

- OUR PRODUCT IS MADE OF MS58/MS63 BRASS LOW PRESSURE INGOTS
- SURFACE COATING IS PAINTED 916.
- OUTPUT LENGTH 120 mm
- PRODUCT HEIGHT 200 mm
- 40 BAR PRESSURE RESISTANT CERAMIC CARTRIDGE USED
- WATER FLOW IS BETWEEN 19 AND 23 PER MINUTE
- G 3/8 M-10 40 BAR PRESSURE RESISTANT STEEL BRAIDED FLEX USED

4 | 4.450,00 ₺  
Code: 32 2010 0360

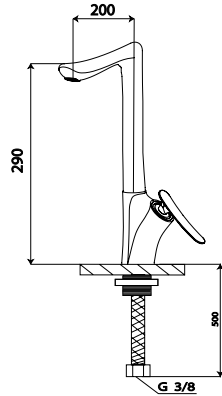

### Mix Kuğu Mutfak Bataryası

- ÜRÜNÜMÜZ MS58 PİRİNÇ MALZEMEDEN ÜRETİLMİŞTİR.
- YÜZEY KAPLAMASI PULVER 916 BOYADIR.
- ÇIKIŞ UCU UZUNLUĞU 185 mm'DİR.
- ÇIKIŞ UCU YÜKSEKLİĞİ 280 mm'DİR.
- SU AKIŞ BORUSU ÇAP 22mm, SU AKIŞ BORUSU MS63 PİRİNÇTİR.
- 360 DERECE DÖNER BORULUDUR.
- 40 BAR BASINCA DAYANIKLI SERAMİK KARTUŞ KULLANILMAKTADIR.
- PERLATÖRÜN SU AKIŞ DEBİSİ DAKİKADA 12 İLE 18 lt ARASINDADIR.
- 3/8 M-10 40 BAR BASINCA DAYANIKLI ÇELİK ÖRGÜLÜ FLEX KULLANILMIŞTIR.

### Mix Swan Kitchen Faucet

- OUR PRODUCT IS MADE OF MS58 BRASS.
- SURFACE COATING IS PAINTED 916.
- OUTPUT LENGTH 225mm
- OUTPUT END PIPE HEIGHT IS 310mm
- SPECIAL WATER FLOW PIPE, OUR PRODUCT IS MADE OF MS58/MS63 BRASS LOW PRESSURE INGOTS
- 360 ROTARY PIPE
- 40 BAR PRESSURE RESISTANT CERAMIC CARTRIDGE USED
- WATER FLOW IS BETWEEN 13 AND 18 PER MINUTE

4 | 6.200,00 ₺  
Code: 32 2010 0361

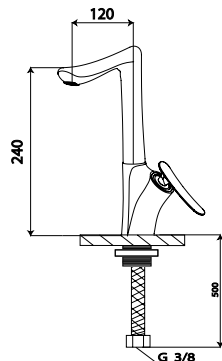

### Mix Kuğu Lavabo Bataryası

- ÜRÜNÜMÜZ MS58 PİRİNÇ MALZEMEDEN ÜRETİLMİŞTİR.
- YÜZEY KAPLAMASI PULVER 916 BOYADIR.
- ÇIKIŞ UCU UZUNLUĞU 120mm'DİR.
- ÇIKIŞ UCU YÜKSEKLİĞİ 240mm'DİR.
- ÖZEL SU AKIŞ BORUSU, BORU MS58/MS63 ORANINDA ALÇAK BASINÇ PİRİNÇ KÜLÇEDEN ÜRETİLMİŞTİR.
- 360 DERECE DÖNER BORULUDUR.
- 40 BAR BASINCA DAYANIKLI SERAMİK KARTUŞ KULLANILMAKTADIR.
- PERLATÖRÜN SU AKIŞ DEBİSİ DAKİKADA 12 İLE 18 lt ARASINDADIR.
- 3/8 M-10 40 BAR BASINCA DAYANIKLI ÇELİK ÖRGÜLÜ FLEX KULLANILMIŞTIR.

### Mix Swan Basın Faucet

- OUR PRODUCT IS MADE OF MS58 BRASS
- SURFACE COATING IS PAINTED 916.
- OUTPUT LENGTH 120mm
- OUTPUT END PIPE HEIGHT IS 240mm
- SPECIAL WATER FLOW PIPE, OUR PRODUCT IS MADE OF MS58/MS63 BRASS LOW PRESSURE INGOTS
- 360 ROTARY PIPE
- 40 BAR PRESSURE RESISTANT CERAMIC CARTRIDGE USED
- WATER FLOW IS BETWEEN 13 AND 18 PER MINUTE
- G 3/8 M-10 40 BAR PRESSURE RESISTANT STEEL BRAIDED FLEX USED

4 | 5.100,00 ₺  
Code: 32 2010 0362

## Mix Banyo Bataryası

- ÜRÜNÜMÜZ MS58/MS63 ORANINDA ALÇAK BASINÇ PİRİNÇ KÜLÇEDEN ÜRETİLMİŞTİR.
- YÜZEY KAPLAMASI PULVER 916 BOYADIR.
- ÇIKIŞ UCU UZUNLUĞU 200 mm'DİR.
- 40 BAR BASINCA DAYANIKLI SERAMİK KARTUŞ KULLANILMAKTADIR.
- PERLATÖRÜN SU AKIŞ DEBİSİ DAKİKADA19 İLE 23 lt ARASINDADIR.
- YÖNLENDİRİCİ TAKIMI MS58 PİRİNÇTEN ÜRETİLMİŞTİR.
- TESİSAT BAĞLANTILARI G ½' DİR.
- EL DUŞU BAĞLANTISI G ½' DİR.

## Mix Bathroom Faucet

- OUR PRODUCT IS MADE OF MS58/MS63 BRASS LOW PRESSURE INGOTS
- SURFACE COATING IS PAINTED 916.
- OUTPUT LENGTH 200mm
- 40 BAR PRESSURE RESISTANT CERAMIC CARTRIDGE USED
- WATER FLOW IS BETWEEN 19 AND 23 PER MINUTE
- THE ROYTER TOOLS WAS MADE BRASS'S
- INSTALLATION CONNECTIONS ARE G ½
- HAND SHOWER CONNECTIONS ARE G ½

4 | 4.750,00₺  
Code: 32 2010 0363

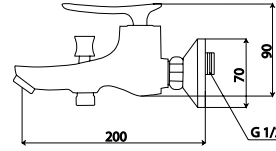

## BEYAZ & ROSS



## Mix Lavabo Bataryası

- ÜRÜNÜMÜZ MS58/MS63 ORANINDA ALÇAK BASINÇ PİRİNÇ KÜLÇEDEN ÜRETİLMİŞTİR.
- YÜZEY KAPLAMASI PULVER 916 BOYADIR.
- ÇIKIŞ UCU UZUNLUĞU 120 mm'DİR.
- ÜRÜN YÜKSEKLİĞİ 200 mm'DİR.
- 40 BAR BASINCA DAYANIKLI SERAMİK KARTUŞ KULLANILMAKTADIR.
- PERLATÖRÜN SU AKIŞ DEBİSİ DAKİKADA19 İLE 23 lt ARASINDADIR.
- 3/8 M-10 40 BAR BASINCA DAYANIKLI ÇELİK ÖRGÜLÜ FLEX KULLANILMIŞTIR.

## Mix Basin Faucet

- OUR PRODUCT IS MADE OF MS58/MS63 BRASS LOW PRESSURE INGOTS
- SURFACE COATING IS PAINTED 916.
- OUTPUT LENGTH 120 mm
- PRODUCT HEIGHT 200 mm
- 40 BAR PRESSURE RESISTANT CERAMIC CARTRIDGE USED
- WATER FLOW IS BETWEEN 19 AND 23 PER MINUTE
- G 3/8 M-10 40 BAR PRESSURE RESISTANT STEEL BRAIDED FLEX USED

4 | 4.450,00₺  
Code: 32 2010 0364

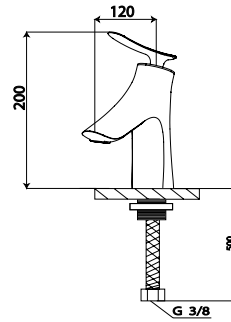

## Mix Kuğu Mutfak Bataryası

- ÜRÜNÜMÜZ MS58 PİRİNÇ MALZEMEDEN ÜRETİLMİŞTİR.
- YÜZEY KAPLAMASI PULVER 916 BOYADIR.
- ÇIKIŞ UCU UZUNLUĞU 185 mm'DİR.
- ÇIKIŞ UCU YÜKSEKLİĞİ 280 mm'DİR.
- SU AKIŞ BORUSU ÇAPİ 22mm, SU AKIŞ BORUSU MS63 PİRİNÇTİR.
- 360 DERECE DÖNER BORULUDUR.
- 40 BAR BASINCA DAYANIKLI SERAMİK KARTUŞ KULLANILMAKTADIR.
- PERLATÖRÜN SU AKIŞ DEBİSİ DAKİKADA12 İLE 18 lt ARASINDADIR.
- 3/8 M-10 40 BAR BASINCA DAYANIKLI ÇELİK ÖRGÜLÜ FLEX KULLANILMIŞTIR.

## Mix Swan Kitchen Faucet

- OUR PRODUCT IS MADE OF MS58 BRASS.
- SURFACE COATING IS PAINTED 916.
- OUTPUT LENGTH 225mm
- OUTPUT END PIPE HEIGHT IS 310mm
- SPECIAL WATER FLOW PIPE, OUR PRODUCT IS MADE OF MS58/MS63 BRASS LOW PRESSURE INGOTS
- 360 ROTARY PIPE
- 40 BAR PRESSURE RESISTANT CERAMIC CARTRIDGE USED
- WATER FLOW IS BETWEEN 13 AND 18 PER MINUTE
- G 3/8 M-10 40 BAR PRESSURE RESISTANT STEEL BRAIDED FLEX USED

4 | 6.200,00₺  
Code: 32 2010 0365

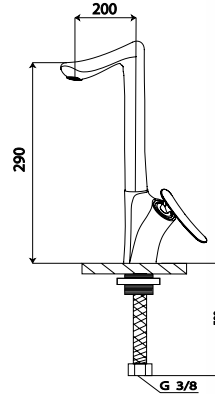

## Mix Kuğu Lavabo Bataryası

- ÜRÜNÜMÜZ MS58 PİRİNÇ MALZEMEDEN ÜRETİLMİŞTİR.
- YÜZEY KAPLAMASI PULVER 916 BOYADIR.
- ÇIKIŞ UCU UZUNLUĞU 120mm'DİR.
- ÇIKIŞ UCU YÜKSEKLİĞİ 240mm'DİR.
- ÖZEL SU AKIŞ BORUSU, BORU MS58/MS63 ORANINDA ALÇAK BASINÇ PİRİNÇ KÜLÇEDEN ÜRETİLMİŞTİR.
- 360 DERECE DÖNER BORULUDUR.
- 40 BAR BASINCA DAYANIKLI SERAMİK KARTUŞ KULLANILMAKTADIR.
- PERLATÖRÜN SU AKIŞ DEBİSİ DAKİKADA12 İLE 18 lt ARASINDADIR.
- 3/8 M-10 40 BAR BASINCA DAYANIKLI ÇELİK ÖRGÜLÜ FLEX KULLANILMIŞTIR.

## Mix Swan Basin Faucet

- OUR PRODUCT IS MADE OF MS58 BRASS
- SURFACE COATING IS PAINTED 916.
- OUTPUT LENGTH 120mm
- OUTPUT END PIPE HEIGHT IS 240mm
- SPECIAL WATER FLOW PIPE, OUR PRODUCT IS MADE OF MS58/MS63 BRASS LOW PRESSURE INGOTS
- 360 ROTARY PIPE
- 40 BAR PRESSURE RESISTANT CERAMIC CARTRIDGE USED
- WATER FLOW IS BETWEEN 13 AND 18 PER MINUTE
- G 3/8 M-10 40 BAR PRESSURE RESISTANT STEEL BRAIDED FLEX USED

4 | 5.100,00₺  
Code: 32 2010 0366

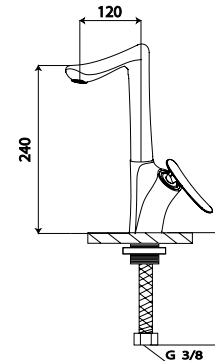



## CARISMA SERİSİ



GÜVENİLİR ÜRÜN

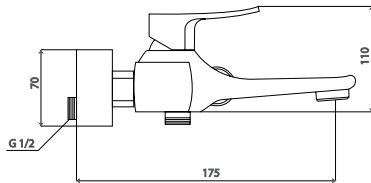

### Mix Banyo Bataryası

- ÇIKIŞ UCU UZUNLUĞU 135 mm'DİR.
- 40 BAR BASINCA DAYANIKLI SERAMİK KARTUŞ KULLANILMAKTADIR.
- TESİSAT BAĞLANTILARI G ½' DİR.
- EL DUŞU BAĞLANTISI G ½' DİR.

### Mix Bathroom Faucet

- OUTPUT LENGTH 135mm
- 40 BAR PRESSURE RESISTANT CERAMIC CARTRIDGE USED
- INSTALLATION CONNECTIONS ARE G ½
- HAND SHOWER CONNECTIONS ARE G ½

12 | 4.850,00 ₺  
Code: 34 2010 0520



GÜVENİLİR ÜRÜN

### Mix Kuğu Mutfak Bataryası

- ÇIKIŞ UCU UZUNLUĞU 200 mm'DİR.
- ÇIKIŞ UCU YÜKSEKLİĞİ 350 mm'DİR.
- 360 DERECE DÖNER BORULUDUR.
- 40 BAR BASINCA DAYANIKLI SERAMİK KARTUŞ KULLANILMAKTADIR.
- 3/8 M-10 40 BAR BASINCA DAYANIKLI ÇELİK ÖRGÜLÜ FLEX KULLANILMIŞTIR.

### Mix Kitchen Faucet

- OUTPUT LENGTH 200mm
- OUTPUT END PIPE HEIGHT IS 350mm
- 360 ROTARY PIPE
- 40 BAR PRESSURE RESISTANT CERAMIC CARTRIDGE USED
- G 3/8 M-10 40 BAR PRESSURE RESISTANT STEEL BRAIDED FLEX USED

12 | 4.850,00 ₺  
Code: 34 2010 0522

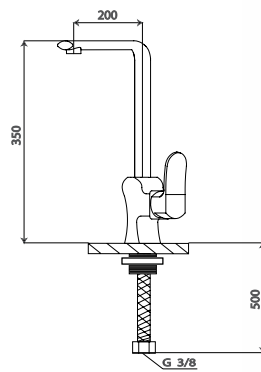

### Mix Lavabo Bataryası

- ÇIKIŞ UCU UZUNLUĞU 115 mm'DİR.
- ÜRÜN YÜKSEKLİĞİ 180 mm'DİR.
- 40 BAR BASINCA DAYANIKLI SERAMİK KARTUŞ KULLANILMAKTADIR.
- 3/8 M-10 40 BAR BASINCA DAYANIKLI ÇELİK ÖRGÜLÜ FLEX KULLANILMIŞTIR.

### Mix Basin Faucet

- OUTPUT LENGTH 115 mm
- PRODUCT HEIGHT 180 mm
- 40 BAR PRESSURE RESISTANT CERAMIC CARTRIDGE USED
- G 3/8 M-10 40 BAR PRESSURE RESISTANT STEEL BRAIDED FLEX USED

12 | 3.800,00 ₺  
Code: 34 2010 0521

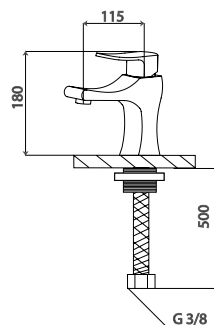





**Mix Banyo Bataryası**

- ÇIKIŞ UCU UZUNLUĞU 145 mm'DİR.
- 40 BAR BASINCA DAYANIKLI SERAMİK KARTUŞ KULLANILMAKTADIR.
- TESİSAT BAĞLANTILARI G ½' DİR.
- EL DUŞU BAĞLANTISI G ½' DİR.

**Mix Bathroom Faucet**

- OUTPUT LENGTH 145mm
- 40 BAR PRESSURE RESISTANT CERAMIC CARTRIDGE USED
- INSTALLATION CONNECTIONS ARE G ½
- HAND SHOWER CONNECTIONS ARE G ½

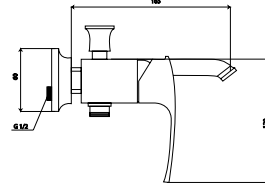

12 | 4.850,00 ₺

Code: 34 2010 0570

**Mix Kuşu Mutfak Bataryası**

- ÇIKIŞ UCU UZUNLUĞU 190 mm'DİR.
- ÇIKIŞ UCU YÜKSEKLİĞİ 310 mm'DİR.
- 360 DERECE DÖNER BORULUDUR.
- 40 BAR BASINCA DAYANIKLI SERAMİK KARTUŞ KULLANILMAKTADIR.
- 3/8 M-10 40 BAR BASINCA DAYANIKLI ÇELİK ÖRGÜLÜ FLEX KULLANILMIŞTIR.

**Mix Kitchen Faucet**

- OUTPUT LENGTH 190mm
- OUTPUT END PIPE HEIGHT IS 310mm
- 360 ROTARY PIPE
- 40 BAR PRESSURE RESISTANT CERAMIC CARTRIDGE USED
- G 3/8 M-10 40 BAR PRESSURE RESISTANT STEEL BRAIDED FLEX USED

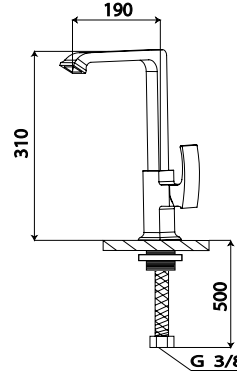

12 | 4.900,00 ₺

Code: 34 2010 0571

**Mix Lavabo Bataryası**

- ÇIKIŞ UCU UZUNLUĞU 125 mm'DİR.
- ÜRÜN YÜKSEKLİĞİ 165 mm'DİR.
- 40 BAR BASINCA DAYANIKLI SERAMİK KARTUŞ KULLANILMAKTADIR.
- 3/8 M-10 40 BAR BASINCA DAYANIKLI ÇELİK ÖRGÜLÜ FLEX KULLANILMIŞTIR.

**Mix Basin Faucet**

- OUTPUT LENGTH 125 mm
- PRODUCT HEIGHT 165 mm
- 40 BAR PRESSURE RESISTANT CERAMIC CARTRIDGE USED
- G 3/8 M-10 40 BAR PRESSURE RESISTANT STEEL BRAIDED FLEX USED

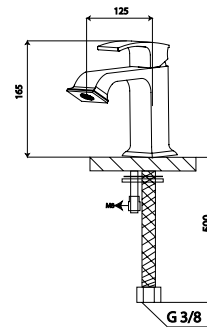

12 | 3.800,00 ₺

Code: 34 2010 0572



**Mix Banyo Bataryası**

- ÇIKIŞ UCU UZUNLUĞU 175 mm'DİR.
- 40 BAR BASINCA DAYANIKLI SERAMİK KARTUŞ KULLANILMAKTADIR.
- TESİSAT BAĞLANTILARI G ½' DİR.
- EL DUŞU BAĞLANTISI G ½' DİR.

**Mix Bathroom Faucet**

- OUTPUT LENGTH 175mm
- 40 BAR PRESSURE RESISTANT CERAMIC CARTRIDGE USED
- INSTALLATION CONNECTIONS ARE G ½
- HAND SHOWER CONNECTIONS ARE G ½

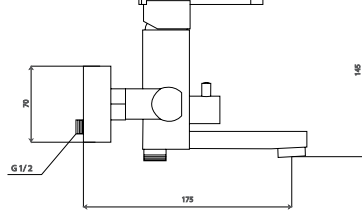

12 | 6.300,00 ₺  
Code: 36 2010 0101

**Mix Lavabo Bataryası**

- ÇIKIŞ UCU UZUNLUĞU 110 mm'DİR.
- ÜRÜN YÜKSEKLİĞİ 185 mm'DİR.
- 40 BAR BASINCA DAYANIKLI SERAMİK KARTUŞ KULLANILMAKTADIR.
- 3/8 M-10 40 BAR BASINCA DAYANIKLI ÇELİK ÖRGÜLÜ FLEX KULLANILMIŞTIR.

**Mix Basin Faucet**

- OUTPUT LENGTH 110 mm
- PRODUCT HEIGHT 185 mm
- 40 BAR PRESSURE RESISTANT CERAMIC CARTRIDGE USED
- G 3/8 M-10 40 BAR PRESSURE RESISTANT STEEL BRAIDED FLEX USED

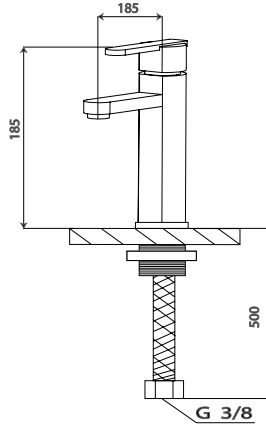

12 | 5.600,00 ₺  
Code: 36 2010 0102

**Mix Kuğu Mutfak Bataryası**

- ÇIKIŞ UCU UZUNLUĞU 205 mm'DİR.
- ÇIKIŞ UCU YÜKSEKLİĞİ 340 mm'DİR.
- 360 DERECE DÖNER BORULUDUR.
- 40 BAR BASINCA DAYANIKLI SERAMİK KARTUŞ KULLANILMAKTADIR.
- 3/8 M-10 40 BAR BASINCA DAYANIKLI ÇELİK ÖRGÜLÜ FLEX KULLANILMIŞTIR.

**Mix Kitchen Faucet**

- OUTPUT LENGTH 205mm
- OUTPUT END PIPE HEIGHT IS 340mm
- 360 ROTARY PIPE
- 40 BAR PRESSURE RESISTANT CERAMIC CARTRIDGE USED
- G 3/8 M-10 40 BAR PRESSURE RESISTANT STEEL BRAIDED FLEX USED

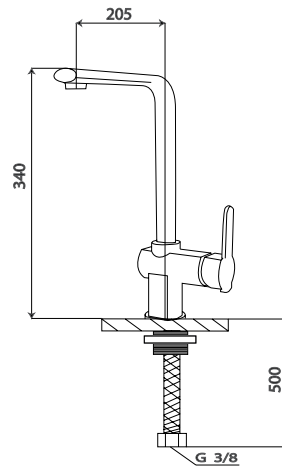

12 | 5.990,00 ₺  
Code: 36 2010 0103



**Mix Banyo Bataryası**

- ÇIKIŞ UCU UZUNLUĞU 210 mm'DİR.
- SU AKIŞI ÇIKIŞ UCUNDAN YAPILMAKTADIR.
- 40 BAR BASINCA DAYANIKLI SERAMİK KARTUŞ KULLANILMAKTADIR.
- TESİSAT BAĞLANTILARI G ½' DİR.
- EL DUŞU BAĞLANTISI G ½' DİR.

**Mix Bathroom Faucet**

- OUTPUT LENGTH 210mm
- WATER FLOW IS MADE FROM THE OUTPUT END
- 40 BAR PRESSURE RESISTANT CERAMIC CARTRIDGE USED
- INSTALLATION CONNECTIONS ARE G ½
- HAND SHOWER CONNECTIONS ARE G ½

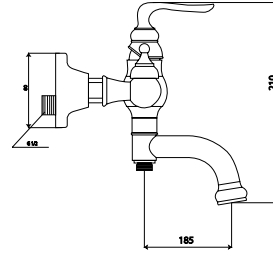

4 | 7.280,00 ₺  
Code: 32 2010 2000

**Mix Kuğu Mutfak Bataryası**

- ÇIKIŞ UCU UZUNLUĞU 210 mm'DİR.
- ÇIKIŞ UCU YÜKSEKLİĞİ 365 mm'DİR.
- 360 DERECE DÖNER BORULUDUR.
- 40 BAR BASINCA DAYANIKLI SERAMİK KARTUŞ KULLANILMAKTADIR.
- 3/8 M-10 40 BAR BASINCA DAYANIKLI ÇELİK ÖRGÜLÜ FLEX KULLANILMIŞTIR.

**Mix Kitchen Faucet**

- OUTPUT LENGTH 210mm
- OUTPUT END PIPE HEIGHT IS 365mm
- 360 ROTARY PIPE
- 40 BAR PRESSURE RESISTANT CERAMIC CARTRIDGE USED
- G 3/8 M-10 40 BAR PRESSURE RESISTANT STEEL BRAIDED FLEX USED

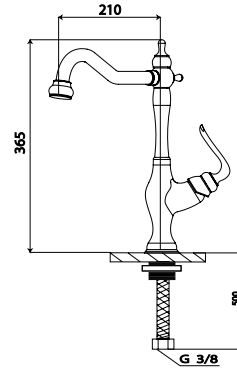

4 | 7.280,00 ₺  
Code: 32 2010 2001

**Mix Lavabo Bataryası**

- ÇIKIŞ UCU UZUNLUĞU 165 mm'DİR.
- ÜRÜN YÜKSEKLİĞİ 230 mm'DİR.
- 40 BAR BASINCA DAYANIKLI SERAMİK KARTUŞ KULLANILMAKTADIR.
- 3/8 M-10 40 BAR BASINCA DAYANIKLI ÇELİK ÖRGÜLÜ FLEX KULLANILMIŞTIR.

**Mix Basin Faucet**

- OUTPUT LENGTH 165 mm
- PRODUCT HEIGHT 230 mm
- 40 BAR PRESSURE RESISTANT CERAMIC CARTRIDGE USED
- G 3/8 M-10 40 BAR PRESSURE RESISTANT STEEL BRAIDED FLEX USED

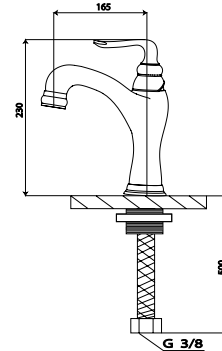

4 | 6.850,00 ₺  
Code: 32 2010 2003

**Mix Çanak Lavabo Bataryası**

- ÇIKIŞ UCU UZUNLUĞU 165 mm'DİR.
- ÜRÜN YÜKSEKLİĞİ 320 mm'DİR.
- 40 BAR BASINCA DAYANIKLI SERAMİK KARTUŞ KULLANILMAKTADIR.
- 3/8 M-10 40 BAR BASINCA DAYANIKLI ÇELİK ÖRGÜLÜ FLEX KULLANILMIŞTIR.

**Mix Bowl Basin Mixer**

- OUTPUT LENGTH 165 mm
- PRODUCT HEIGHT 320 mm
- 40 BAR PRESSURE RESISTANT CERAMIC CARTRIDGE USED
- G 3/8 M-10 40 BAR PRESSURE RESISTANT STEEL BRAIDED FLEX USED

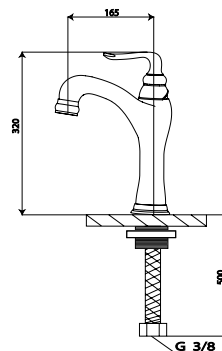

4 | 7.200,00 ₺  
Code: 32 2010 2002

Siyah - Sarı Renkli



## Mix Banyo Bataryası

- ÇIKIŞ UCU UZUNLUĞU 185 mm'DİR.
- SU AKIŞI ÇIKIŞ UCUNDAN YAPILMAKTADIR
- YÜZEY KAPLAMASI PULVER 916 BOYADIR.
- 40 BAR BASINCA DAYANIKLI SERAMİK KARTUŞ KULLANILMAKTADIR.
- TESİSAT BAĞLANTILARI G ½' DİR.
- EL DUŞU BAĞLANTISI G ½' DİR.

## Mix Bathroom Faucet

- OUTPUT LENGTH 185mm
- WATER FLOW IS MADE FROM THE OUTPUT END
- SURFACE COATING IS PAINTED 916.
- 40 BAR PRESSURE RESISTANT CERAMIC CARTRIDGE USED
- INSTALLATION CONNECTIONS ARE G ½
- HAND SHOWER CONNECTIONS ARE G ½

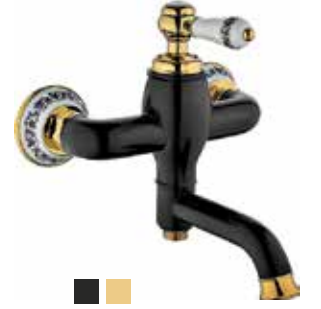
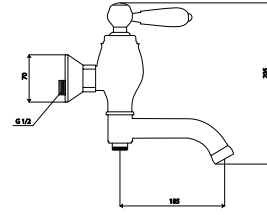

4 | 6.670,00 ₺  
Code: 32 2010 0370

## Mix Lavabo Bataryası

- ÇIKIŞ UCU UZUNLUĞU 170 mm'DİR.
- YÜZEY KAPLAMASI PULVER 916 BOYADIR.
- ÜRÜN YÜKSEKLİĞİ 210 mm'DİR.
- 40 BAR BASINCA DAYANIKLI SERAMİK KARTUŞ KULLANILMAKTADIR.
- 3/8 M-10 40 BAR BASINCA DAYANIKLI ÇELİK ÖRGÜLÜ FLEX KULLANILMIŞTIR.

## Mix Basin Faucet

- OUTPUT LENGTH 170 mm
- SURFACE COATING IS PAINTED 916.
- PRODUCT HEIGHT 210 mm
- 40 BAR PRESSURE RESISTANT CERAMIC CARTRIDGE USED
- G 3/8 M-10 40 BAR PRESSURE RESISTANT STEEL BRAIDED FLEX USED

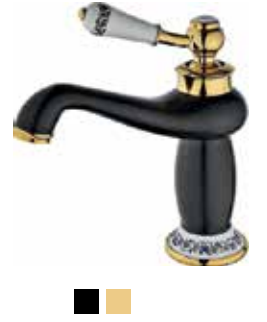
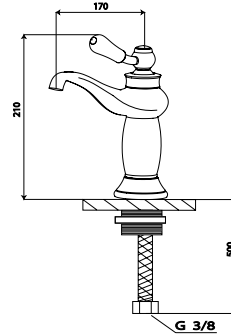

4 | 5.350,00 ₺  
Code: 32 2010 0372

## Mix Kuğu Mutfak Bataryası

- ÇIKIŞ UCU UZUNLUĞU 180 mm'DİR.
- YÜZEY KAPLAMASI PULVER 916 BOYADIR.
- ÇIKIŞ UCU YÜKSEKLİĞİ 400 mm'DİR.
- 360 DERECE DÖNER BORULUDUR.
- 40 BAR BASINCA DAYANIKLI SERAMİK KARTUŞ KULLANILMAKTADIR.
- 3/8 M-10 40 BAR BASINCA DAYANIKLI ÇELİK ÖRGÜLÜ FLEX KULLANILMIŞTIR.

## Mix Kitchen Faucet

- OUTPUT LENGTH 180mm
- SURFACE COATING IS PAINTED 916.
- OUTPUT END PIPE HEIGHT IS 400mm
- 360 ROTARY PIPE
- 40 BAR PRESSURE RESISTANT CERAMIC CARTRIDGE USED
- G 3/8 M-10 40 BAR PRESSURE RESISTANT STEEL BRAIDED FLEX USED

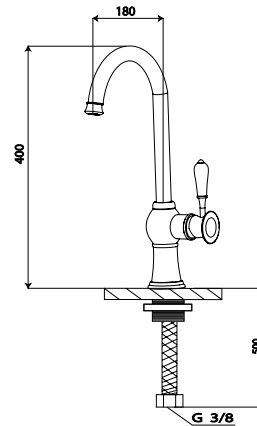

4 | 6.650,00 ₺  
Code: 32 2010 0371

Beyaz - Sarı Renkli

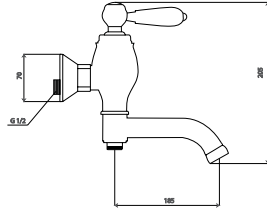

**Mix Banyo Bataryası**

- ÇIKIŞ UCU UZUNLUĞU 185 mm'DİR.
- SU AKIŞI ÇIKIŞ UCUNDAN YAPILMAKTADIR.
- YÜZEY KAPLAMASI PULVER 916 BOYADIR.
- 40 BAR BASINCA DAYANIKLI SERAMİK KARTUŞ KULLANILMAKTADIR.
- TESİSAT BAĞLANTILARI G ½' DİR.
- EL DUŞU BAĞLANTISI G ½' DİR.

**Mix Bathroom Faucet**

- OUTPUT LENGTH 185mm
- WATER FLOW IS MADE FROM THE OUTPUT END
- SURFACE COATING IS PAINTED 916.
- 40 BAR PRESSURE RESISTANT CERAMIC CARTRIDGE USED
- INSTALLATION CONNECTIONS ARE G ½
- HAND SHOWER CONNECTIONS ARE G ½

4 | 6.670,00 ₺

Code: 32 2010 0373

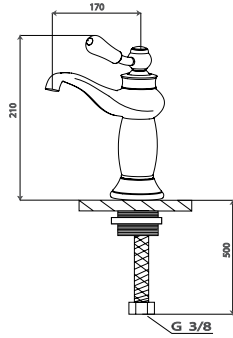

**Mix Lavabo Bataryası**

- ÇIKIŞ UCU UZUNLUĞU 170 mm'DİR.
- YÜZEY KAPLAMASI PULVER 916 BOYADIR.
- ÜRÜN YÜKSEKLİĞİ 210 mm'DİR.
- 40 BAR BASINCA DAYANIKLI SERAMİK KARTUŞ KULLANILMAKTADIR.
- 3/8 M-10 40 BAR BASINCA DAYANIKLI ÇELİK ÖRGÜLÜ FLEX KULLANILMIŞTIR.

**Mix Basin Faucet**

- OUTPUT LENGTH 170 mm
- SURFACE COATING IS PAINTED 916.
- PRODUCT HEIGHT 210 mm
- 40 BAR PRESSURE RESISTANT CERAMIC CARTRIDGE USED
- 3/8 M-10 40 BAR PRESSURE RESISTANT STEEL BRAIDED FLEX USED

4 | 5.350,00 ₺

Code: 32 2010 0375

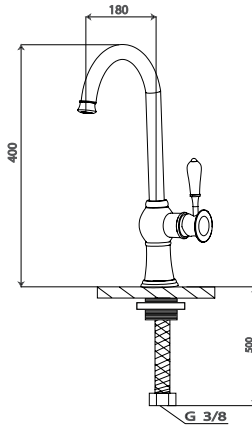

**Mix Kuğu Mutfak Bataryası**

- ÇIKIŞ UCU UZUNLUĞU 180 mm'DİR.
- YÜZEY KAPLAMASI PULVER 916 BOYADIR.
- ÇIKIŞ UCU YÜKSEKLİĞİ 400 mm'DİR.
- 360 DERECE DÖNER BORULUDUR.
- 40 BAR BASINCA DAYANIKLI SERAMİK KARTUŞ KULLANILMAKTADIR.
- 3/8 M-10 40 BAR BASINCA DAYANIKLI ÇELİK ÖRGÜLÜ FLEX KULLANILMIŞTIR.

**Mix Kitchen Faucet**

- OUTPUT LENGTH 180mm
- SURFACE COATING IS PAINTED 916.
- OUTPUT END PIPE HEIGHT IS 400mm
- 360 ROTARY PIPE
- 40 BAR PRESSURE RESISTANT CERAMIC CARTRIDGE USED
- G 3/8 M-10 40 BAR PRESSURE RESISTANT STEEL BRAIDED FLEX USED

4 | 6.650,00 ₺

Code: 32 2010 0374



**Mafsallı Duş Seti  
Shower Set**

4 | 4.450,00 ₺

Code: 49 2010 1455



## Sarı Renkli

### Mix Banyo Bataryası

- ÇIKIŞ UCU UZUNLUĞU 180 mm'DİR.
- SU AKIŞI ÇIKIŞ UCUNDAN YAPILMAKTADIR
- YÜZEY KAPLAMASI ÖZEL ALTIN BOYADIR.
- 40 BAR BASINCA DAYANIKLI SERAMİK KARTUŞ KULLANILMAKTADIR.
- TESİSAT BAĞLANTILARI G ½' DİR.
- EL DUŞU BAĞLANTISI G ½' DİR.

### Mix Bathroom Faucet

- OUTPUT LENGTH 180mm
- WATER FLOW IS MADE FROM THE OUTPUT END
- SURFACE COATING IS SPECIAL GOLD PAINT.
- 40 BAR PRESSURE RESISTANT CERAMIC CARTRIDGE USED
- INSTALLATION CONNECTIONS ARE G ½
- HAND SHOWER CONNECTIONS ARE G ½

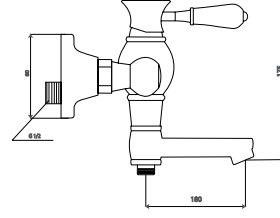

4 | 6.670,00 ₺  
Code: 32 2010 0376

### Mix Lavabo Bataryası

- ÇIKIŞ UCU UZUNLUĞU 160 mm'DİR.
- YÜZEY KAPLAMASI ÖZEL ALTIN BOYADIR.
- ÜRÜN YÜKSEKLİĞİ 185 mm'DİR.
- 40 BAR BASINCA DAYANIKLI SERAMİK KARTUŞ KULLANILMAKTADIR.
- 3/8 M-10 40 BAR BASINCA DAYANIKLI ÇELİK ÖRGÜLÜ FLEX KULLANILMIŞTIR.

### Mix Basin Faucet

- OUTPUT LENGTH 160 mm
- SURFACE COATING IS SPECIAL GOLD PAINT.
- PRODUCT HEIGHT 185 mm
- 40 BAR PRESSURE RESISTANT CERAMIC CARTRIDGE USED
- G 3/8 M-10 40 BAR PRESSURE RESISTANT STEEL BRAIDED FLEX USED

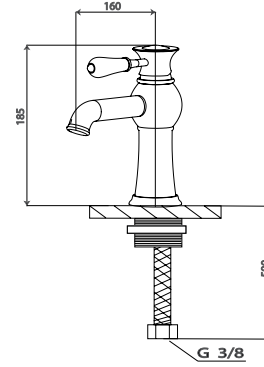

4 | 5.350,00 ₺  
Code: 32 2010 0378

### Mix Kuğu Mutfak Bataryası

- ÇIKIŞ UCU UZUNLUĞU 180 mm'DİR.
- YÜZEY KAPLAMASI ÖZEL ALTIN BOYADIR.
- ÇIKIŞ UCU YÜKSEKLİĞİ 370 mm'DİR.
- 360 DERECE DÖNER BORULUDUR.
- 40 BAR BASINCA DAYANIKLI SERAMİK KARTUŞ KULLANILMAKTADIR.
- 3/8 M-10 40 BAR BASINCA DAYANIKLI ÇELİK ÖRGÜLÜ FLEX KULLANILMIŞTIR.

### Mix Kitchen Faucet

- OUTPUT LENGTH 180mm
- SURFACE COATING IS SPECIAL GOLD PAINT.
- OUTPUT END PIPE HEIGHT IS 370mm
- 360 ROTARY PIPE
- 40 BAR PRESSURE RESISTANT CERAMIC CARTRIDGE USED
- G 3/8 M-10 40 BAR PRESSURE RESISTANT STEEL BRAIDED FLEX USED

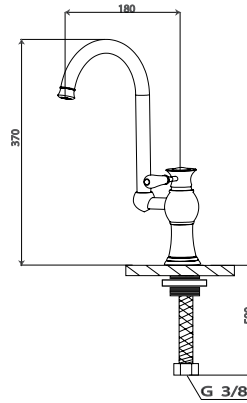

4 | 6.650,00 ₺  
Code: 32 2010 0377

ROKA



6 | 4.900,00₺  
Code: 41 2010 0648

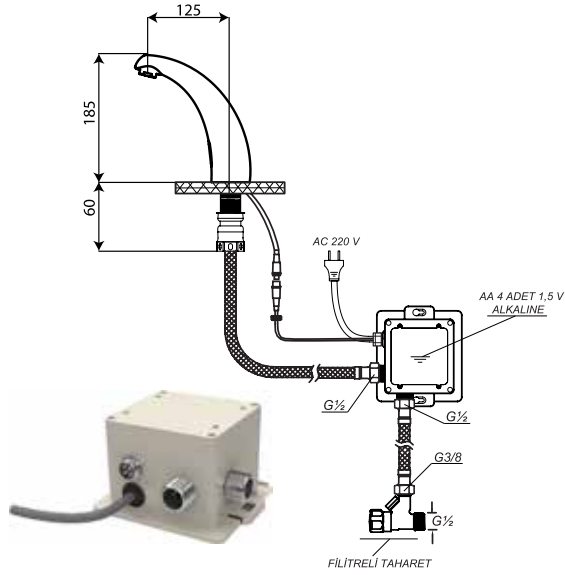

**Tek Girişli Fotoselli Lavabo Bataryası**

- ÜRÜNÜMÜZ MS/58/MS63 ORANINDA ALÇAK BASINÇ KÜLÇEDEN ÜRETİLMİŞTİR.
- YÜZEY KAPLAMASI 0,12 İLE 0,16 MİKRON KROM KAPLAMADIR.
- TEK SU GİRİŞLİDİR
- SU ÇIKIŞ UZUNLUĞU 125mm'DİR.
- SU ÇIKIŞ YÜKSEKLİĞİ 185mm'DİR.
- G 3/8 1/2 40 BAR BASINCA DAYANIKLI ÇELİK ÖRGÜLÜ FLEX KULLANILMIŞTIR.
- G 1/2 M-10 40 BAR BASINCA DAYANIKLI ÇELİK ÖRGÜLÜ FLEX KULLANILMIŞTIR.
- 220 VOLT GÜÇ KAYNAĞI İŞE ÇALIŞIR.
- AYRICA ELEKTİRİK KESİLMELERİNDE 4 ADET 1,5 V AA KALEM PİL İLE ÇALIŞABİLİR.
- ÜRÜN İÇERİSİNDE 1 ADET FİLTRELİ TAHARET MUSLUK MEVCUTTUR.

**Single Photocell Basin Faucet**

- OUR PRODUCT IS MADE OF MS58 BRASS
- SURFACE COATING IS 0,16mm CHROME COATING
- SURFACE COATING IS SPECIAL GOLD PAINT.
- SINGLE WATER INLET
- OUTPUT LENGTH 125mm
- OUTPUT END PIPE HEIGHT IS 185mm
- G 3/8 1/2 40 BAR PRESSURE RESISTANT STEEL BRAIDED FLEX USED
- G 1/2 M-10 40 BAR PRESSURE RESISTANT STEEL BRAIDED FLEX USED
- WORKS WITH 220 V POWER SUPPLY



6 | 5.900,00₺  
Code: 41 2010 0649

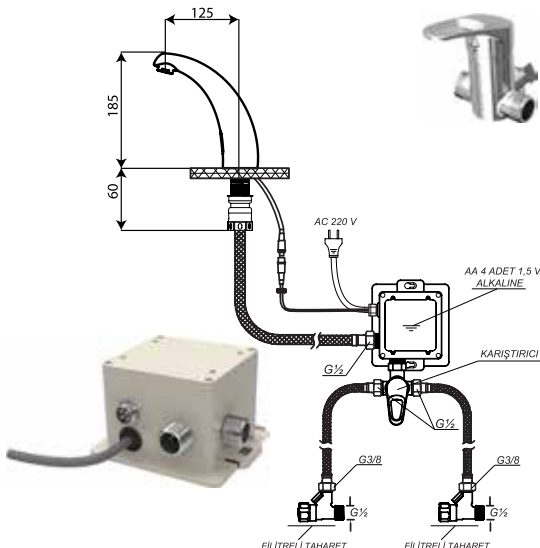

**Çift Girişli Fotoselli Lavabo Bataryası**

- ÜRÜNÜMÜZ MS/58/MS63 ORANINDA ALÇAK BASINÇ KÜLÇEDEN ÜRETİLMİŞTİR.
- YÜZEY KAPLAMASI 0,12 İLE 0,16 MİKRON KROM KAPLAMADIR.
- ÇİFT SU GİRİŞLİR.ÜRÜNDE KARIŞTIRICI MEVCUTTUR.
- SU ÇIKIŞ UZUNLUĞU 125mm'DİR.
- SU ÇIKIŞ YÜKSEKLİĞİ 185mm'DİR.
- G 3/8 1/2 40 BAR BASINCA DAYANIKLI ÇELİK ÖRGÜLÜ FLEX KULLANILMIŞTIR.
- G 1/2 M-10 40 BAR BASINCA DAYANIKLI ÇELİK ÖRGÜLÜ FLEX KULLANILMIŞTIR.
- 220 VOLT GÜÇ KAYNAĞI İŞE ÇALIŞIR.
- AYRICA ELEKTİRİK KESİLMELERİNDE 4 ADET 1,5 V AA KALEM PİL İLE ÇALIŞABİLİR.
- ÜRÜN İÇERİSİNDE 2 ADET FİLTRELİ TAHARET MUSLUK MEVCUTTUR.

**Double Photocell Basin Faucet**

- OUR PRODUCT IS MADE OF MS58 BRASS
- SURFACE COATING IS 0,16mm CHROME COATING
- DOUBLE WATER INLET
- OUTPUT LENGTH 125mm
- OUTPUT END PIPE HEIGHT IS 185mm
- G 3/8 1/2 40 BAR PRESSURE RESISTANT STEEL BRAIDED FLEX USED
- G 1/2 M-10 40 BAR PRESSURE RESISTANT STEEL BRAIDED FLEX USED
- WORKS WITH 220 V POWER SUPPLY



4 | 5.400,00 ₺  
Code: 41 2010 0661

### Tek Girişli Fotoselli Lavabo Bataryası

- ÜRÜNÜMÜZ MS/58/MS63 ORANINDA ALÇAK BASINÇ KÜLÇEDEN ÜRETİLMİŞTİR.
- YÜZEY KAPLAMASI 0,12 İLE 0,16 MİKRON KROM KAPLAMADIR.
- TEK SU GİRİŞLİDİR
- SU ÇIKIŞ UZUNLUĞU 115mm'DİR.
- SU ÇIKIŞ YÜKSEKLİĞİ 155mm'DİR.
- G 3/8 1/2 40 BAR BASINCA DAYANIKLI ÇELİK ÖRGÜLÜ FLEX KULLANILMIŞTIR.
- G 1/2 M-10 40 BAR BASINCA DAYANIKLI ÇELİK ÖRGÜLÜ FLEX KULLANILMIŞTIR.
- 220 VOLT GÜÇ KAYNAĞI İŞE ÇALIŞIR.
- AYRICA ELEKTİRİK KESİLMELERİNDE 4 ADET 1,5 V AA KALEM PİL İLE ÇALIŞABİLİR.
- ÜRÜN İÇERİSİNDE 1 ADET FİLTRELİ TAHARET MUSLUK MEVCUTTUR.

### Single Photocell Basin Faucet

- OUR PRODUCT IS MADE OF MS58 BRASS
- SURFACE COATING IS 0,16mm CHROME COATING
- SINGLE WATER INLET
- OUTPUT LENGTH 115mm
- OUTPUT END PIPE HEIGHT IS 155mm
- G 3/8 1/2 40 BAR PRESSURE RESISTANT STEEL BRAIDED FLEX USED
- G 1/2 M-10 40 BAR PRESSURE RESISTANT STEEL BRAIDED FLEX USED
- WORKS WITH 220 V POWER SUPPLY

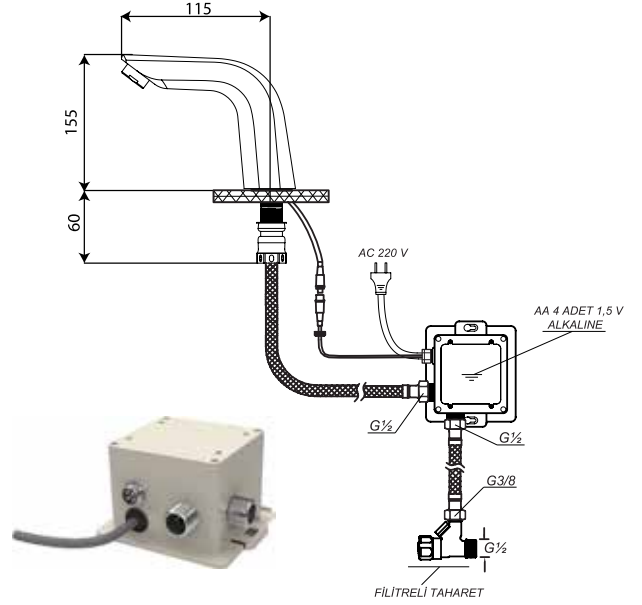

4 | 6.400,00 ₺  
Code: 41 2010 0662

### Çift Girişli Fotoselli Lavabo Bataryası

- ÜRÜNÜMÜZ MS/58/MS63 ORANINDA ALÇAK BASINÇ KÜLÇEDEN ÜRETİLMİŞTİR.
- YÜZEY KAPLAMASI 0,12 İLE 0,16 MİKRON KROM KAPLAMADIR.
- ÇİFT SU GİRİŞLİR.ÜRÜNDE KARIŞTIRICI MEVCUTTUR.
- SU ÇIKIŞ UZUNLUĞU 115mm'DİR.
- SU ÇIKIŞ YÜKSEKLİĞİ 155mm'DİR.
- G 3/8 1/2 40 BAR BASINCA DAYANIKLI ÇELİK ÖRGÜLÜ FLEX KULLANILMIŞTIR.
- G 1/2 M-10 40 BAR BASINCA DAYANIKLI ÇELİK ÖRGÜLÜ FLEX KULLANILMIŞTIR.
- 220 VOLT GÜÇ KAYNAĞI İŞE ÇALIŞIR.
- AYRICA ELEKTİRİK KESİLMELERİNDE 4 ADET 1,5 V AA KALEM PİL İLE ÇALIŞABİLİR.
- ÜRÜN İÇERİSİNDE 2 ADET FİLTRELİ TAHARET MUSLUK MEVCUTTUR.

### Double Photocell Basin Faucet

- OUR PRODUCT IS MADE OF MS58 BRASS
- SURFACE COATING IS 0,16mm CHROME COATING
- DOUBLE WATER INLET
- OUTPUT LENGTH 115mm
- OUTPUT END PIPE HEIGHT IS 155mm
- G 3/8 1/2 40 BAR PRESSURE RESISTANT STEEL BRAIDED FLEX USED
- G 1/2 M-10 40 BAR PRESSURE RESISTANT STEEL BRAIDED FLEX USED
- WORKS WITH 220 V POWER SUPPLY

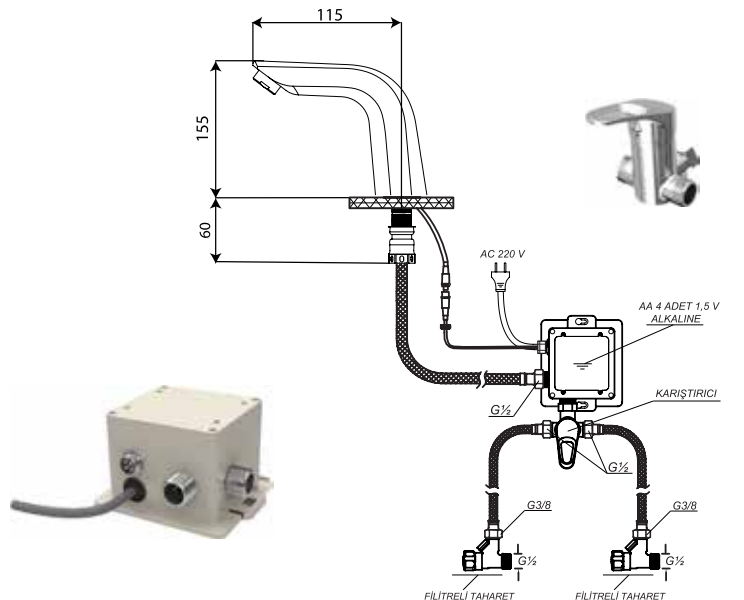

ROKA



- **Kırmızı**  
Code: 41 2010 2601
- **Beyaz**  
Code: 41 2010 2602
- **Siyah**  
Code: 41 2010 2603

6 5.400,00 ₺

- **Altın**  
Code: 41 2010 2604
- **Eskitme**  
Code: 41 2010 2605
- **İnci Siyah**  
Code: 41 2010 2606
- **Saten**  
Code: 41 2010 2607

6 5.950,00 ₺

**Tek Girişli Fotoselli Lavabo Bataryası**

- ÜRÜNÜMÜZ MS/58/MS63 ORANINDA ALÇAK BASINÇ KÜLÇEDEN ÜRETİLMİŞTİR.
- YÜZEY KAPLAMASI ÖZEL ALTIN BOYADIR.
- YÜZEY KAPLAMASI PULVER 916 BOYADIR.
- TEK SU GİRİŞLİDİR
- SU ÇIKIŞ UZUNLUĞU 125mm'DİR.
- SU ÇIKIŞ YÜKSEKLİĞİ 185mm'DİR.
- G 3/8 1/2 40 BAR BASINCA DAYANIKLI ÇELİK ÖRGÜLÜ FLEX KULLANILMIŞTIR.
- G 1/2 M-10 40 BAR BASINCA DAYANIKLI ÇELİK ÖRGÜLÜ FLEX KULLANILMIŞTIR.
- 220 VOLT GÜÇ KAYNAĞI İŞE ÇALIŞIR.
- AYRICA ELEKTİRİK KESİLMELERİNDE 4 ADET 1,5 V AA KALEM PİL İLE ÇALIŞABİLİR.
- ÜRÜN İÇERİSİNDE 1 ADET FİLTRELİ TAHARET MUSLUK MEVCUTTUR.

**Single Photocell Basin Faucet**

- OUR PRODUCT IS MADE OF MS58 BRASS
- SURFACE COATING IS SPECIAL GOLD PAINT.
- SURFACE COATING IS PAINTED 916.
- SINGLE WATER INLET
- OUTPUT LENGTH 125mm
- OUTPUT END PIPE HEIGHT IS 185mm
- G 3/8 1/2 40 BAR PRESSURE RESISTANT STEEL BRAIDED FLEX USED
- G 1/2 M-10 40 BAR PRESSURE RESISTANT STEEL BRAIDED FLEX USED
- WORKS WITH 220 V POWER SUPPLY

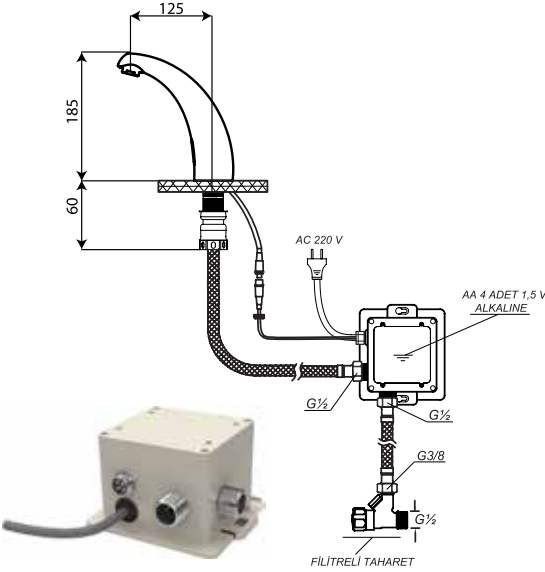

- **Kırmızı**  
Code: 41 2010 2608
- **Beyaz**  
Code: 41 2010 2609
- **Siyah**  
Code: 41 2010 2610

6 6.400,00 ₺

- **Altın**  
Code: 41 2010 2611
- **Eskitme**  
Code: 41 2010 2612
- **İnci Siyah**  
Code: 41 2010 2613
- **Saten**  
Code: 41 2010 2614

6 6.950,00 ₺

**Çift Girişli Fotoselli Lavabo Bataryası**

- ÜRÜNÜMÜZ MS/58/MS63 ORANINDA ALÇAK BASINÇ KÜLÇEDEN ÜRETİLMİŞTİR.
- YÜZEY KAPLAMASI ÖZEL ALTIN BOYADIR.
- YÜZEY KAPLAMASI PULVER 916 BOYADIR.
- ÇİFT SU GİRİŞLİR.ÜRÜNDE KARIŞTIRICI MEVCUTTUR.
- SU ÇIKIŞ UZUNLUĞU 125mm'DİR.
- SU ÇIKIŞ YÜKSEKLİĞİ 185mm'DİR.
- G 3/8 1/2 40 BAR BASINCA DAYANIKLI ÇELİK ÖRGÜLÜ FLEX KULLANILMIŞTIR.
- G 1/2 M-10 40 BAR BASINCA DAYANIKLI ÇELİK ÖRGÜLÜ FLEX KULLANILMIŞTIR.
- 220 VOLT GÜÇ KAYNAĞI İŞE ÇALIŞIR.
- AYRICA ELEKTİRİK KESİLMELERİNDE 4 ADET 1,5 V AA KALEM PİL İLE ÇALIŞABİLİR.
- ÜRÜN İÇERİSİNDE 2 ADET FİLTRELİ TAHARET MUSLUK MEVCUTTUR.

**Double Photocell Basin Faucet**

- OUR PRODUCT IS MADE OF MS58 BRASS
- SURFACE COATING IS SPECIAL GOLD PAINT.
- SURFACE COATING IS PAINTED 916.
- DOUBLE WATER INLET
- OUTPUT LENGTH 125mm
- OUTPUT END PIPE HEIGHT IS 185mm
- G 3/8 1/2 40 BAR PRESSURE RESISTANT STEEL BRAIDED FLEX USED
- G 1/2 M-10 40 BAR PRESSURE RESISTANT STEEL BRAIDED FLEX USED
- WORKS WITH 220 V POWER SUPPLY

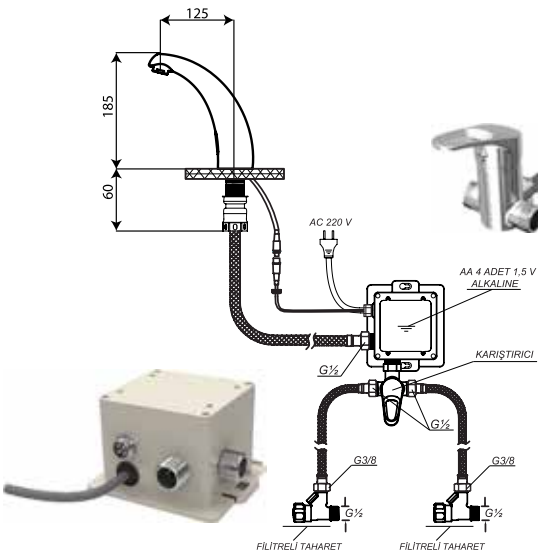

- **Kırmızı**  
Code: 41 2010 2615
- **Beyaz**  
Code: 41 2010 2616
- **Siyah**  
Code: 41 2010 2617

6 | 5.900,00 ₺

- **Altın**  
Code: 41 2010 2618
- **Eskitme**  
Code: 41 2010 2619
- **İnci Siyah**  
Code: 41 2010 2620
- **Saten**  
Code: 41 2010 2621

6 | 6.500,00 ₺

### Tek Girişli Fotoselli Lavabo Bataryası

- ÜRÜNÜMÜZ MS/58/MS63 ORANINDA ALÇAK BASINÇ KÜLÇEDEN ÜRETİLMİŞTİR.
- YÜZEY KAPLAMASI ÖZEL ALTIN BOYADIR.
- YÜZEY KAPLAMASI PULVER 916 BOYADIR.
- SU ÇIKIŞ UZUNLUĞU 115mm'DİR.
- SU ÇIKIŞ YÜKSEKLİĞİ 155mm'DİR.
- G 3/8 1/2 40 BAR BASINCA DAYANIKLI ÇELİK ÖRGÜLÜ FLEX KULLANILMIŞTIR.
- G 1/2 M-10 40 BAR BASINCA DAYANIKLI ÇELİK ÖRGÜLÜ FLEX KULLANILMIŞTIR.
- 220 VOLT GÜÇ KAYNAĞI İŞE ÇALIŞIR.
- AYRICA ELEKTİRİK KESİLMELERİNDE 4 ADET 1,5 V AA KALEM PİL İLE ÇALIŞABİLİR.
- ÜRÜN İÇERİSİNDE 1 ADET FİLTRELİ TAHARET MUSLUK MEVCUTTUR.

### Single Photocell Basin Faucet

- OUR PRODUCT IS MADE OF MS58 BRASS
- SURFACE COATING IS SPECIAL GOLD PAINT.
- SURFACE COATING IS PAINTED 916.
- SINGLE WATER INLET
- OUTPUT LENGTH 115mm
- OUTPUT END PIPE HEIGHT IS 155mm
- G 3/8 1/2 40 BAR PRESSURE RESISTANT STEEL BRAIDED FLEX USED
- G 1/2 M-10 40 BAR PRESSURE RESISTANT STEEL BRAIDED FLEX USED
- WORKS WITH 220 V POWER SUPPLY

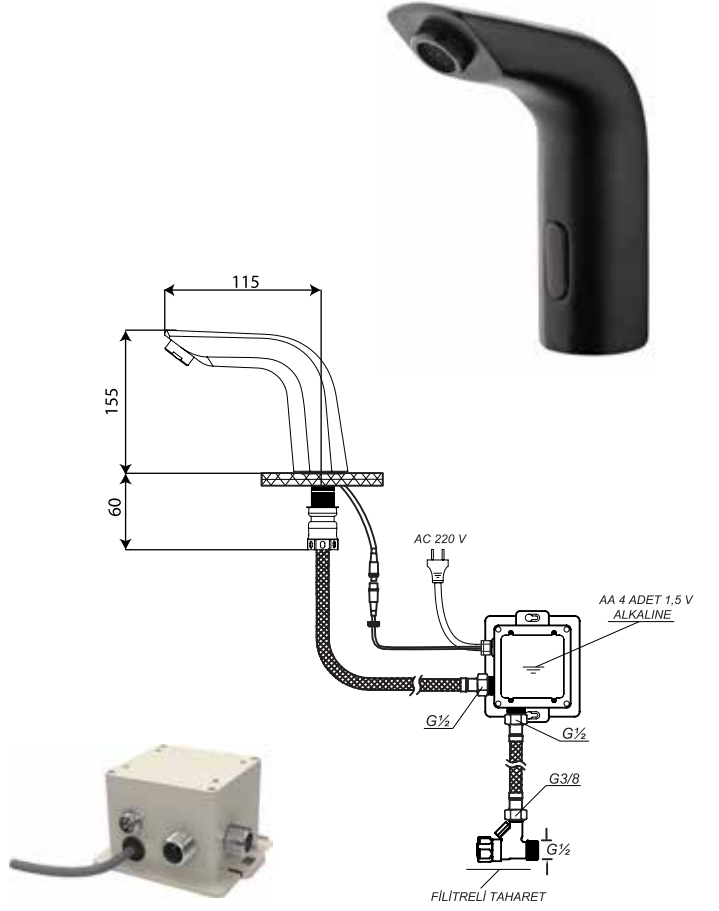

- **Kırmızı**  
Code: 41 2010 2622
- **Beyaz**  
Code: 41 2010 2623
- **Siyah**  
Code: 41 2010 2624

6 | 6.900,00 ₺

- **Altın**  
Code: 41 2010 2625
- **Eskitme**  
Code: 41 2010 2626
- **İnci Siyah**  
Code: 41 2010 2627
- **Saten**  
Code: 41 2010 2628

6 | 7.500,00 ₺

### Çift Girişli Fotoselli Lavabo Bataryası

- ÜRÜNÜMÜZ MS/58/MS63 ORANINDA ALÇAK BASINÇ KÜLÇEDEN ÜRETİLMİŞTİR.
- YÜZEY KAPLAMASI ÖZEL ALTIN BOYADIR.
- YÜZEY KAPLAMASI PULVER 916 BOYADIR.
- ÇİFT SU GİRİŞLİ.ÜRÜNDE KARIŞTIRICI MEVCUTTUR.
- SU ÇIKIŞ UZUNLUĞU 115mm'DİR.
- SU ÇIKIŞ YÜKSEKLİĞİ 155mm'DİR.
- G 3/8 1/2 40 BAR BASINCA DAYANIKLI ÇELİK ÖRGÜLÜ FLEX KULLANILMIŞTIR.
- G 1/2 M-10 40 BAR BASINCA DAYANIKLI ÇELİK ÖRGÜLÜ FLEX KULLANILMIŞTIR.
- 220 VOLT GÜÇ KAYNAĞI İŞE ÇALIŞIR.
- AYRICA ELEKTİRİK KESİLMELERİNDE 4 ADET 1,5 V AA KALEM PİL İLE ÇALIŞABİLİR.
- ÜRÜN İÇERİSİNDE 2 ADET FİLTRELİ TAHARET MUSLUK MEVCUTTUR.

### Double Photocell Basin Faucet

- OUR PRODUCT IS MADE OF MS58 BRASS
- SURFACE COATING IS SPECIAL GOLD PAINT.
- SURFACE COATING IS PAINTED 916.
- DOUBLE WATER INLET
- OUTPUT LENGTH 115mm
- OUTPUT END PIPE HEIGHT IS 155mm
- G 3/8 1/2 40 BAR PRESSURE RESISTANT STEEL BRAIDED FLEX USED
- G 1/2 M-10 40 BAR PRESSURE RESISTANT STEEL BRAIDED FLEX USED
- WORKS WITH 220 V POWER SUPPLY

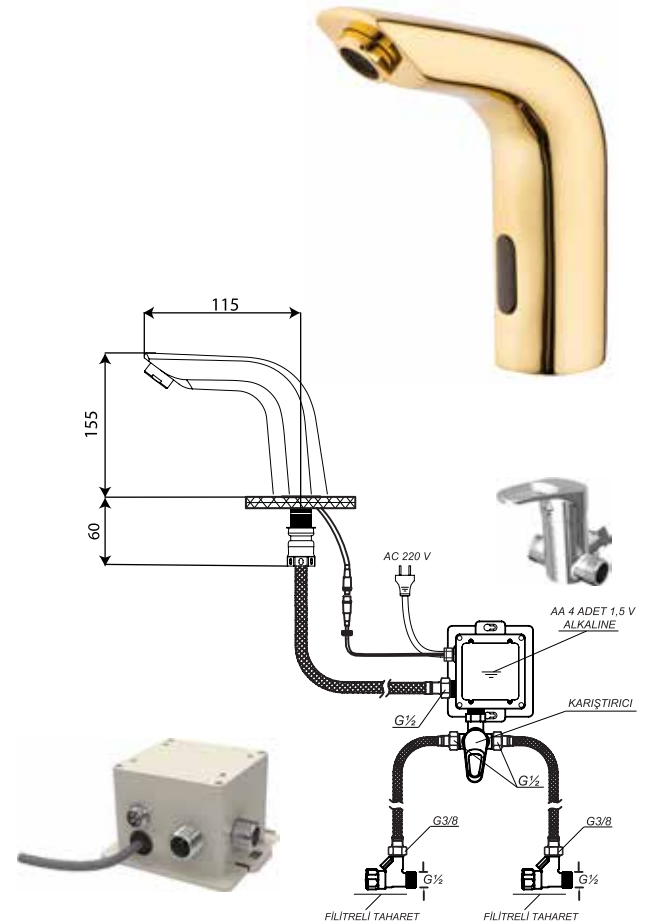

ROKA

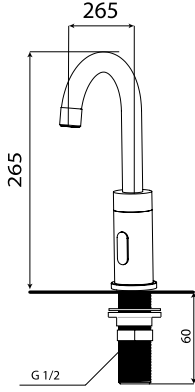

**Tek Girişli Fotoselli Lavabo Bataryası**

- ÜRÜNÜMÜZ MS/58/MS63 ORANINDA ALÇAK BASINÇ KÜLÇEDEN ÜRETİLMİŞTİR.
- YÜZEY KAPLAMASI 0,12 İLE 0,16 MİKRON KROM KAPLAMADIR.
- TEK SU GİRİŞLİDİR
- SU ÇIKIŞ UZUNLUĞU 125mm'DİR.
- SU ÇIKIŞ YÜKSEKLİĞİ 185mm'DİR.
- G 3/8 1/2 40 BAR BASINCA DAYANIKLI ÇELİK ÖRGÜLÜ FLEX KULLANILMIŞTIR.
- G 1/2 M-10 40 BAR BASINCA DAYANIKLI ÇELİK ÖRGÜLÜ FLEX KULLANILMIŞTIR.
- 220 VOLT GÜÇ KAYNAĞI İŞE ÇALIŞIR.
- AYRICA ELEKTİRİK KESİLMELERİNDE 4 ADET 1,5 V AA KALEM PİL İLE ÇALIŞABİLİR.
- ÜRÜN İÇERİSİNDE 1 ADET FİLTRELİ TAHARET MUSLUK MEVCUTTUR.

**Single Photocell Basin Faucet**

- OUR PRODUCT IS MADE OF MS58 BRASS
- SURFACE COATING IS 0,16mm CHROME COATING
- SURFACE COATING IS SPECIAL GOLD PAINT.
- SINGLE WATER INLET
- OUTPUT LENGTH 125mm
- OUTPUT END PIPE HEIGHT IS 185mm
- G 3/8 1/2 40 BAR PRESSURE RESISTANT STEEL BRAIDED FLEX USED
- G 1/2 M-10 40 BAR PRESSURE RESISTANT STEEL BRAIDED FLEX USED
- WORKS WITH 220 V POWER SUPPLY

6 | 4.900,00₺  
Code: 41 2010 0650

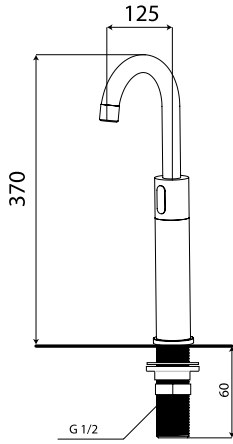

**Tek Girişli Fotoselli Çanak Lavabo Bataryası**

- ÜRÜNÜMÜZ MS/58/MS63 ORANINDA ALÇAK BASINÇ KÜLÇEDEN ÜRETİLMİŞTİR.
- YÜZEY KAPLAMASI 0,12 İLE 0,16 MİKRON KROM KAPLAMADIR.
- TEK SU GİRİŞLİDİR
- SU ÇIKIŞ UZUNLUĞU 125mm'DİR.
- SU ÇIKIŞ YÜKSEKLİĞİ 185mm'DİR.
- G 3/8 1/2 40 BAR BASINCA DAYANIKLI ÇELİK ÖRGÜLÜ FLEX KULLANILMIŞTIR.
- G 1/2 M-10 40 BAR BASINCA DAYANIKLI ÇELİK ÖRGÜLÜ FLEX KULLANILMIŞTIR.
- 220 VOLT GÜÇ KAYNAĞI İŞE ÇALIŞIR.
- AYRICA ELEKTİRİK KESİLMELERİNDE 4 ADET 1,5 V AA KALEM PİL İLE ÇALIŞABİLİR.
- ÜRÜN İÇERİSİNDE 1 ADET FİLTRELİ TAHARET MUSLUK MEVCUTTUR.

**Single Photocell High Basin Faucet**

- OUR PRODUCT IS MADE OF MS58 BRASS
- SURFACE COATING IS 0,16mm CHROME COATING
- SURFACE COATING IS SPECIAL GOLD PAINT.
- SINGLE WATER INLET
- OUTPUT LENGTH 125mm
- OUTPUT END PIPE HEIGHT IS 185mm
- G 3/8 1/2 40 BAR PRESSURE RESISTANT STEEL BRAIDED FLEX USED
- G 1/2 M-10 40 BAR PRESSURE RESISTANT STEEL BRAIDED FLEX USED
- WORKS WITH 220 V POWER SUPPLY

6 | 5.600,00₺  
Code: 41 2010 0652

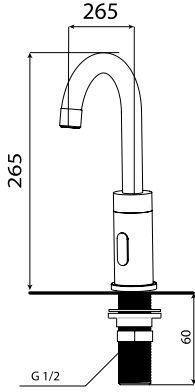

**Çift Girişli Fotoselli Lavabo Bataryası**

- ÜRÜNÜMÜZ MS/58/MS63 ORANINDA ALÇAK BASINÇ KÜLÇEDEN ÜRETİLMİŞTİR.
- YÜZEY KAPLAMASI 0,12 İLE 0,16 MİKRON KROM KAPLAMADIR.
- ÇİFT SU GİRİŞLİR.ÜRÜNDE KARİŞTİRİCİ MEVCUTTUR.
- SU ÇIKIŞ UZUNLUĞU 125mm'DİR.
- SU ÇIKIŞ YÜKSEKLİĞİ 185mm'DİR.
- G 3/8 1/2 40 BAR BASINCA DAYANIKLI ÇELİK ÖRGÜLÜ FLEX KULLANILMIŞTIR.
- G 1/2 M-10 40 BAR BASINCA DAYANIKLI ÇELİK ÖRGÜLÜ FLEX KULLANILMIŞTIR.
- 220 VOLT GÜÇ KAYNAĞI İŞE ÇALIŞIR.
- AYRICA ELEKTİRİK KESİLMELERİNDE 4 ADET 1,5 V AA KALEM PİL İLE ÇALIŞABİLİR.
- ÜRÜN İÇERİSİNDE 2 ADET FİLTRELİ TAHARET MUSLUK MEVCUTTUR.

**Double Photocell Basin Faucet**

- OUR PRODUCT IS MADE OF MS58 BRASS
- SURFACE COATING IS 0,16mm CHROME COATING
- DOUBLE WATER INLET
- OUTPUT LENGTH 125mm
- OUTPUT END PIPE HEIGHT IS 185mm
- G 3/8 1/2 40 BAR PRESSURE RESISTANT STEEL BRAIDED FLEX USED
- G 1/2 M-10 40 BAR PRESSURE RESISTANT STEEL BRAIDED FLEX USED
- WORKS WITH 220 V POWER SUPPLY

6 | 5.900,00₺  
Code: 41 2010 0651

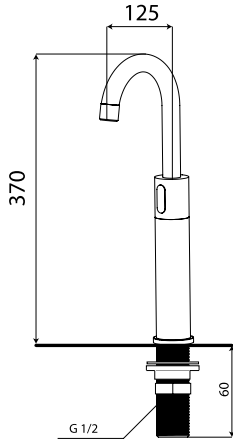

**Çift Girişli Fotoselli Çanak Lavabo Bataryası**

- ÜRÜNÜMÜZ MS/58/MS63 ORANINDA ALÇAK BASINÇ KÜLÇEDEN ÜRETİLMİŞTİR.
- YÜZEY KAPLAMASI 0,12 İLE 0,16 MİKRON KROM KAPLAMADIR.
- ÇİFT SU GİRİŞLİR.ÜRÜNDE KARİŞTİRİCİ MEVCUTTUR.
- SU ÇIKIŞ UZUNLUĞU 125mm'DİR.
- SU ÇIKIŞ YÜKSEKLİĞİ 185mm'DİR.
- G 3/8 1/2 40 BAR BASINCA DAYANIKLI ÇELİK ÖRGÜLÜ FLEX KULLANILMIŞTIR.
- G 1/2 M-10 40 BAR BASINCA DAYANIKLI ÇELİK ÖRGÜLÜ FLEX KULLANILMIŞTIR.
- 220 VOLT GÜÇ KAYNAĞI İŞE ÇALIŞIR.
- AYRICA ELEKTİRİK KESİLMELERİNDE 4 ADET 1,5 V AA KALEM PİL İLE ÇALIŞABİLİR.
- ÜRÜN İÇERİSİNDE 2 ADET FİLTRELİ TAHARET MUSLUK MEVCUTTUR.

**Double Photocell High Basin Faucet**

- OUR PRODUCT IS MADE OF MS58 BRASS
- SURFACE COATING IS 0,16mm CHROME COATING
- DOUBLE WATER INLET
- OUTPUT LENGTH 125mm
- OUTPUT END PIPE HEIGHT IS 185mm
- G 3/8 1/2 40 BAR PRESSURE RESISTANT STEEL BRAIDED FLEX USED
- G 1/2 M-10 40 BAR PRESSURE RESISTANT STEEL BRAIDED FLEX USED
- WORKS WITH 220 V POWER SUPPLY

6 | 6.500,00₺  
Code: 41 2010 0653

## Fotoselli Sıva Üstü Pisuvan

- TEK SU GİRİŞLİDİR
- ÜRÜN UZUNLUĞU 100mm'DİR.
- ÜRÜN YÜKSEKLİĞİ 335mm'DİR.
- GÖVDE İÇERİSİNDE FİLTRE MEVCUTTUR.
- 4 ADET 1,5 V AA KALEM PİL İLE ÇALIŞIR.

## Photocell Over Plaster Urinal

- SINGLE WATER INLET
- PRODUCT LENGTH 100mm.
- PRODUCT HEIGHT 335mm.
- THE PRODUCT HAS FILTER IN IT.
- POWERED BY 4 PIECES 1.5 VOLT BATTERIES.

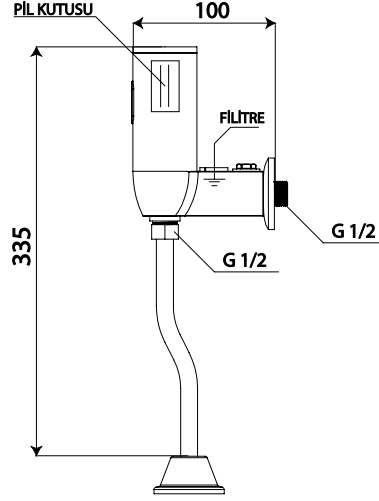

4 | 4.900,00 ₺  
Code: 41 2010 0641

## Fotoselli Sıva Altı Pisuvan

- TEK SU GİRİŞLİDİR
- ÜRÜN GENİŞLİĞİ 133mm'DİR.
- ÜRÜN YÜKSEKLİĞİ 133mm'DİR.
- GÖVDE İÇERİSİNDE FİLTRE MEVCUTTUR.
- 4 ADET 1,5 V AA KALEM PİL İLE ÇALIŞIR.

## Photocell Recessed Urinal

- SINGLE WATER INLET
- PRODUCT WIDTH 133mm.
- PRODUCT HEIGHT 133mm.
- THE PRODUCT HAS FILTER IN IT.
- POWERED BY 4 PIECES 1.5 VOLT BATTERIES.

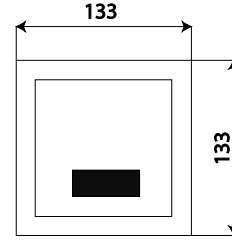

4 | 4.900,00 ₺  
Code: 41 2010 0642

## Fotoselli Çift Girişli Soguk-Sıcak Karıştırıcı

- ÜRÜNÜMÜZ MS58 PİRİNÇ MALZEMEDEN ÜRETİLMİŞTİR.
- YÜZEY KAPLAMASI 0,12 İLE 0,16 MİKRON KROM KAPLAMADIR.
- TEK SU GİRİŞLİDİR.
- ÜRÜN GENİŞLİĞİ 60mm'DİR.
- ÜRÜN YÜKSEKLİĞİ 105mm'DİR.
- TESİSAT BAĞLANTILARI G 1/2'DİR
- ÜRÜN SU ÇIKIŞI G 1/2'DİR
- 40 BAR BASINCA DAYANIKLI SERAMİK KARTUŞ KULLANILMIŞTIR.

## Photocell Double Entry Cold-Hot Mixer

- OUR PRODUCT IS MADE OF MS58 BRASS
- SURFACE COATING IS 0,16mm CHROME COATING
- PRODUCT WIDTH 60mm
- PRODUCT HEIGHT 105mm
- INSTALLATION CONNECTIONS ARE G 1/2
- PRODUCT WATER OUTPUT G1/2
- 40 BAR PRESSURE RESISTANT CERAMIC CARTRIDGE USED
- THE PRODUCT HAS FILTER IN IT.
- POWERED BY 4 PIECES 1.5 VOLT BATTERIES.

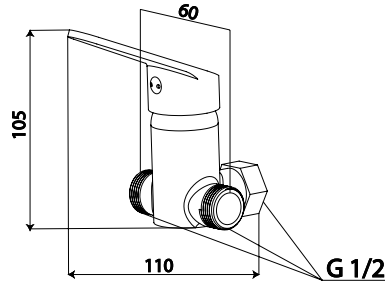

50 | 1.100,00 ₺  
Code: 41 2010 0643

## Fotoselli Motor

- TEK SU GİRİŞLİDİR.
- 220 V İLE ÇALIŞIR.
- 4 ADET 1,5 V AA KALEM PİL İLE ÇALIŞIR.
- MOTOR SU GİRİŞİ 1/2'DİR.
- MOTOR SU ÇIKIŞI 1/2'DİR.
- SENSÖR GÖZÜ ÜRÜNÜN İÇERİSİNDEDİR.

## Photocell Engine

- SINGLE WATER INLET
- WORKS WITH 220 V POWER
- POWERED BY 4 PIECES 1.5 VOLT BATTERIES.
- ENGINE WATER INLET 1/2
- ENGINE WATER OUTPUT 1/2
- INSIDE THE SENSOR EYE

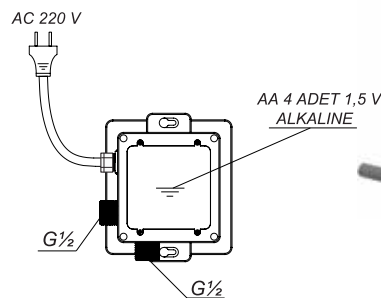

1 | 3.400,00 ₺  
Code: 41 2010 0612

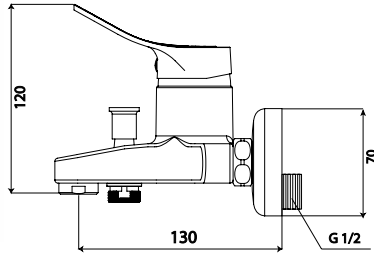

#### Mix Banyo Bataryası

- ÜRÜNÜMÜZ MS58/MS63 ORANINDA ALÇAK BASINÇ PİRİNÇ KÜLÇEDEN ÜRETİLMİŞTİR.
- YÜZEY KAPLAMASI 0,12 İLE 0,16 MİKRON KROM KAPLAMADIR.
- ÇIKIŞ UCU UZUNLUĞU 130 mm'DİR.
- 40 BAR BASINCA DAYANIKLI SERAMİK KARTUŞ KULLANILMAKTADIR.
- PERLATÖRÜN SU AKIŞ DEBİSİ DAKİKADA 19 İLE 23 lt ARASINDADIR.
- YÖNLENDİRİCİ TAKIMI MS58 PİRİNÇTEN ÜRETİLMİŞTİR.
- TESİSAT BAĞLANTILARI G ½' DİR.
- EL DUŞU BAĞLANTISI G ½' DİR.

#### Mix Bathroom Faucet

- OUR PRODUCT IS MADE OF MS58/MS63 BRASS LOW PRESSURE INGOTS
- SURFACE COATING IS 0,16mm CHROME COATING
- OUTPUT LENGTH 130mm
- 40 BAR PRESSURE RESISTANT CERAMIC CARTRIDGE USED
- WATER FLOW IS BETWEEN 19 AND 23 PER MINUTE
- THE ROYTER TOOLS WAS MADE BRASS'S
- INSTALLATION CONNECTIONS ARE G ½
- HAND SHOWER CONNECTIONS ARE G ½

12 | 1.750,00 ₺

Code: 38 2010 0301

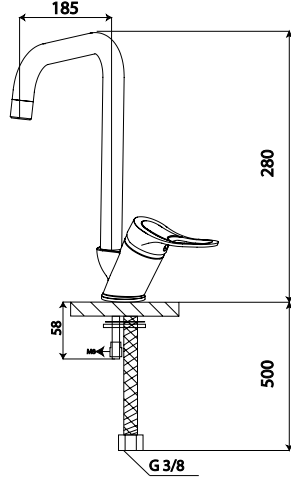

#### Mix Kuğu Mutfak Bataryası

- ÜRÜNÜMÜZ MS58 PİRİNÇ MALZEMEDEN ÜRETİLMİŞTİR.
- YÜZEY KAPLAMASI 0,12 İLE 0,16 MİKRON KROM KAPLAMADIR.
- ÇIKIŞ UCU UZUNLUĞU 185 mm'DİR.
- ÇIKIŞ UCU YÜKSEKLİĞİ 280 mm'DİR.
- SU AKIŞ BORUSU ÇAPI 22mm, SU AKIŞ BORUSU MS63 PİRİNÇTİR.
- 360 DERECE DÖNER BORULUDUR.
- 40 BAR BASINCA DAYANIKLI SERAMİK KARTUŞ KULLANILMAKTADIR.
- PERLATÖRÜN SU AKIŞ DEBİSİ DAKİKADA 12 İLE 18 lt ARASINDADIR.
- 3/8 M-10 40 BAR BASINCA DAYANIKLI ÇELİK ÖRGÜLÜ FLEX KULLANILMIŞTIR.

#### Mix Kitchen Faucet

- OUR PRODUCT IS MADE OF MS58 BRASS
- SURFACE COATING IS 0,16mm CHROME COATING
- OUTPUT LENGTH 185mm
- OUTPUT END PIPE HEIGHT IS 280mm
- THE DIAMETER FO THE PIPE IS 22, THE WATER FLOW PIPE MS63 IS BRASS
- 360 ROTARY PIPE
- 40 BAR PRESSURE RESISTANT CERAMIC CARTRIDGE USED
- WATER FLOW IS BETWEEN 13 AND 18 PER MINUTE
- G 3/8 M-10 40 BAR PRESSURE RESISTANT STEEL BRAIDED FLEX USED

12 | 990,00 ₺

Code: 38 2010 0305

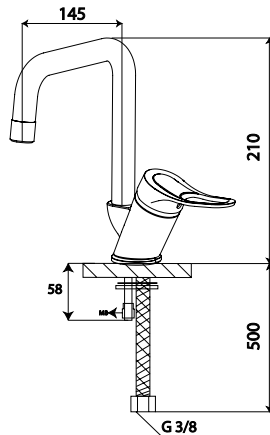

#### Mix Kuğu Lavabo Bataryası

- ÜRÜNÜMÜZ MS58 PİRİNÇ MALZEMEDEN ÜRETİLMİŞTİR.
- YÜZEY KAPLAMASI 0,16 MİKRON KROM KAPLAMADIR.
- ÇIKIŞ UCU UZUNLUĞU 145mm'DİR.
- ÇIKIŞ UCU YÜKSEKLİĞİ 210 mm'DİR.
- SU AKIŞ BORUSU ÇAPI 22mm, SU AKIŞ BORUSU MS63 PİRİNÇ.
- 360 DERECE DÖNER BORULUDUR.
- 40 BAR BASINCA DAYANIKLI SERAMİK KARTUŞ KULLANILMAKTADIR.
- PERLATÖRÜN SU AKIŞ DEBİSİ DAKİKADA 12 İLE 18 lt ARASINDADIR.
- 3/8 M-10 40 BAR BASINCA DAYANIKLI ÇELİK ÖRGÜLÜ FLEX KULLANILMIŞTIR.

#### Mix Basin Faucet

- OUR PRODUCT IS MADE OF MS58 BRASS
- SURFACE COATING IS 0,16mm CHROME COATING
- OUTPUT LENGTH 145mm
- OUTPUT END PIPE HEIGHT IS 210mm
- THE DIAMETER FO THE PIPE IS 22, THE WATER FLOW PIPE MS63 IS BRASS
- 360 ROTARY PIPE
- 40 BAR PRESSURE RESISTANT CERAMIC CARTRIDGE USED
- WATER FLOW IS BETWEEN 13 AND 18 PER MINUTE
- G 3/8 M-10 40 BAR PRESSURE RESISTANT STEEL BRAIDED FLEX USED

12 | 990,00 ₺

Code: 38 2010 0306



## Mix Spiralli Mutfak Bataryası

- ÜRÜNÜMÜZ MS58/MS63 ORANINDA ALÇAK BASINÇ PİRİNÇ KÜLÇEDEN ÜRETİLMİŞTİR.
- YÜZEY KAPLAMASI 0,16 MİKRON KROM KAPLAMADIR.
- ÇIKIŞ UCU UZUNLUĞU 260 mm'DİR.
- 40 BAR BASINCA DAYANIKLI SERAMİK KARTUŞ KULLANILMAKTADIR.
- PERLATÖRÜN SU AKIŞ DEBİSİ DAKİKADA 12 İLE 18 lt ARASINDADIR.
- TESİSAT BAĞLANTILARI G ½' DİR.

## Mix Spiral Kitchen Faucet

- OUR PRODUCT IS MADE OF MS58/MS63 BRASS LOW PRESSURE INGOTS
- SURFACE COATING IS 0,16mm CHROME COATING
- OUTPUT LENGTH 260mm
- 40 BAR PRESSURE RESISTANT CERAMIC CARTRIDGE USED
- WATER FLOW IS BETWEEN 12 AND 18 PER MINUTE
- INSTALLATION CONNECTIONS ARE G ½

12 | 3.730,00 ₺

Code: 38 2010 0312

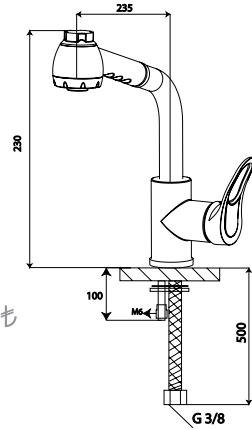

## Mix Duş Bataryası

- ÜRÜNÜMÜZ MS58/MS63 ORANINDA ALÇAK BASINÇ PİRİNÇ KÜLÇEDEN ÜRETİLMİŞTİR.
- YÜZEY KAPLAMASI 0,12 İLE 0,16 MİKRON KROM KAPLAMADIR.
- ÇIKIŞ UCU UZUNLUĞU 175 mm'DİR.
- 40 BAR BASINCA DAYANIKLI SERAMİK KARTUŞ KULLANILMAKTADIR.
- PERLATÖRÜN SU AKIŞ DEBİSİ DAKİKADA 19 İLE 23 lt ARASINDADIR.
- YÖNLENDİRİCİ TAKIMI MS58 PİRİNÇTEN ÜRETİLMİŞTİR.
- TESİSAT BAĞLANTILARI G ½' DİR.
- EL DUŞU BAĞLANTISI G ½' DİR.

## Mix Shower Faucet

- OUR PRODUCT IS MADE OF MS58/MS63 BRASS LOW PRESSURE INGOTS
- SURFACE COATING IS 0,16mm CHROME COATING
- OUTPUT LENGTH 175mm
- 40 BAR PRESSURE RESISTANT CERAMIC CARTRIDGE USED
- WATER FLOW IS BETWEEN 19 AND 23 PER MINUTE
- THE ROYTER TOOLS WAS MADE BRASS'S
- INSTALLATION CONNECTIONS ARE G ½
- HAND SHOWER CONNECTIONS ARE G ½

12 | 1.850,00 ₺

Code: 38 2010 0313

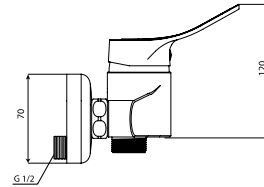

## Mix Duvardan Döner Mutfak Bataryası

- ÜRÜNÜMÜZ MS58/MS63 ORANINDA ALÇAK BASINÇ PİRİNÇ KÜLÇEDEN ÜRETİLMİŞTİR.
- YÜZEY KAPLAMASI 0,16 MİKRON KROM KAPLAMADIR.
- ÇIKIŞ UCU UZUNLUĞU 260 mm'DİR.
- 40 BAR BASINCA DAYANIKLI SERAMİK KARTUŞ KULLANILMAKTADIR.
- PERLATÖRÜN SU AKIŞ DEBİSİ DAKİKADA 12 İLE 18 lt ARASINDADIR.
- TESİSAT BAĞLANTILARI G ½' DİR.

## Mix Wall Mounted Rotating Kitchen Faucet

- OUR PRODUCT IS MADE OF MS58/MS63 BRASS LOW PRESSURE INGOTS
- SURFACE COATING IS 0,16mm CHROME COATING
- OUTPUT LENGTH 260mm
- 40 BAR PRESSURE RESISTANT CERAMIC CARTRIDGE USED
- WATER FLOW IS BETWEEN 12 AND 18 PER MINUTE
- INSTALLATION CONNECTIONS ARE G ½

12 | 2.383,00 ₺

Code: 38 2010 0307

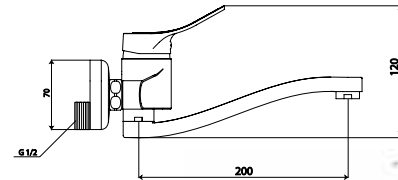

## Mix Berber Bataryası Mix Barber Faucet

12 | 1.750,00 ₺

Code: 38 2010 0311

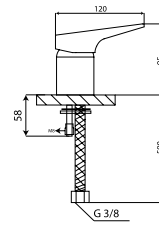
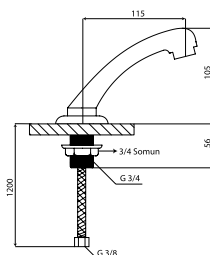

### Mix Banyo Bataryası

- ÜRÜNÜMÜZ MS58/MS63 ORANINDA ALÇAK BASINÇ PİRİNÇ KÜLÇEDEN ÜRETİLMİŞTİR.
- YÜZEY KAPLAMASI 0,12 İLE 0,16 MİKRON KROM KAPLAMADIR.
- ÇIKIŞ UCU UZUNLUĞU 150 mm'DİR.
- 40 BAR BASINCA DAYANIKLI SERAMİK KARTUŞ KULLANILMAKTADIR.
- PERLATÖRÜN SU AKIŞ DEBİSİ DAKİKADA 19 İLE 23 lt ARASINDADIR.
- YÖNLENDİRİCİ TAKIMI MS58 PİRİNÇTEN ÜRETİLMİŞTİR.
- TESİSAT BAĞLANTILARI G ½' DİR.
- EL DUŞU BAĞLANTISI G ½' DİR.

### Mix Bathroom Faucet

- OUR PRODUCT IS MADE OF MS58/MS63 BRASS LOW PRESSURE INGOTS
- SURFACE COATING IS 0,16mm CHROME COATING
- OUTPUT LENGTH 150mm
- 40 BAR PRESSURE RESISTANT CERAMIC CARTRIDGE USED
- WATER FLOW IS BETWEEN 19 AND 23 PER MINUTE
- THE ROYTER TOOLS WAS MADE BRASS'S
- INSTALLATION CONNECTIONS ARE G ½
- HAND SHOWER CONNECTIONS ARE G ½

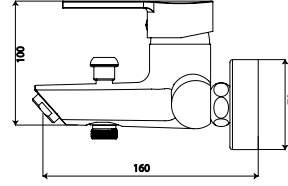

12 | 1.940,00 ₺

Code: 45 2010 2210

### Mix Kuğu Mutfak Bataryası

- ÜRÜNÜMÜZ MS58 PİRİNÇ MALZEMEDEN ÜRETİLMİŞTİR.
- YÜZEY KAPLAMASI 0,12 İLE 0,16 MİKRON KROM KAPLAMADIR.
- ÇIKIŞ UCU UZUNLUĞU 185 mm'DİR.
- ÇIKIŞ UCU YÜKSEKLİĞİ 345 mm'DİR.
- SU AKIŞ BORUSU ÇAPI 22mm, SU AKIŞ BORUSU MS63 PİRİNÇTİR.
- 360 DERECE DÖNER BORULUDUR.
- 40 BAR BASINCA DAYANIKLI SERAMİK KARTUŞ KULLANILMAKTADIR.
- PERLATÖRÜN SU AKIŞ DEBİSİ DAKİKADA 12 İLE 18 lt ARASINDADIR.
- 3/8 M-10 40 BAR BASINCA DAYANIKLI ÇELİK ÖRGÜLÜ FLEX KULLANILMIŞTIR.

### Mix Kitchen Faucet

- OUR PRODUCT IS MADE OF MS58 BRASS
- SURFACE COATING IS 0,16mm CHROME COATING
- OUTPUT LENGTH 185mm
- OUTPUT END PIPE HEIGHT IS 345mm
- THE DIAMETER FO THE PIPE IS 22, THE WATER FLOW PIPE MS63 IS BRASS
- 360 ROTARY PIPE
- 40 BAR PRESSURE RESISTANT CERAMIC CARTRIDGE USED
- WATER FLOW IS BETWEEN 13 AND 18 PER MINUTE
- G 3/8 M-10 40 BAR PRESSURE RESISTANT STEEL BRAIDED FLEX USED

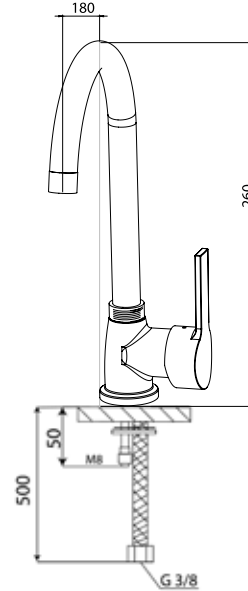

12 | 1.260,00 ₺

Code: 45 2010 2212

### Mix Kuğu Lavabo Bataryası

- ÜRÜNÜMÜZ MS58 PİRİNÇ MALZEMEDEN ÜRETİLMİŞTİR.
- YÜZEY KAPLAMASI 0,16 MİKRON KROM KAPLAMADIR.
- ÇIKIŞ UCU UZUNLUĞU 140 mm'DİR.
- ÇIKIŞ UCU YÜKSEKLİĞİ 270 mm'DİR.
- SU AKIŞ BORUSU ÇAPI 22mm, SU AKIŞ BORUSU MS63 PİRİNÇ.
- 360 DERECE DÖNER BORULUDUR.
- 40 BAR BASINCA DAYANIKLI SERAMİK KARTUŞ KULLANILMAKTADIR.
- PERLATÖRÜN SU AKIŞ DEBİSİ DAKİKADA 12 İLE 18 lt ARASINDADIR.
- 3/8 M-10 40 BAR BASINCA DAYANIKLI ÇELİK ÖRGÜLÜ FLEX KULLANILMIŞTIR.

### Mix Basın Faucet

- OUR PRODUCT IS MADE OF MS58 BRASS
- SURFACE COATING IS 0,16mm CHROME COATING
- OUTPUT LENGTH 140mm
- OUTPUT END PIPE HEIGHT IS 270mm
- THE DIAMETER FO THE PIPE IS 22, THE WATER FLOW PIPE MS63 IS BRASS
- 360 ROTARY PIPE
- 40 BAR PRESSURE RESISTANT CERAMIC CARTRIDGE USED
- WATER FLOW IS BETWEEN 13 AND 18 PER MINUTE
- G 3/8 M-10 40 BAR PRESSURE RESISTANT STEEL BRAIDED FLEX USED

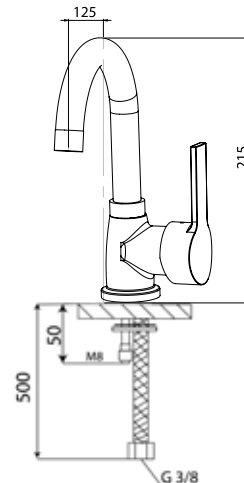

12 | 1.260,00 ₺

Code: 45 2010 2213

**Mix Banyo Bataryası**

- ÜRÜNÜMÜZ MS58/MS63 ORANINDA ALÇAK BASINÇ PİRİNÇ KÜLÇEDEN ÜRETİLMİŞTİR.
- YÜZEY KAPLAMASI 0,12 İLE 0,16 MİKRON KROM KAPLAMADIR.
- ÇIKIŞ UCU UZUNLUĞU 150 mm'DİR.
- 40 BAR BASINCA DAYANIKLI SERAMİK KARTUŞ KULLANILMAKTADIR.
- PERLATÖRÜN SU AKIŞ DEBİSİ DAKİKADA19 İLE 23 lt ARASINDADIR.
- YÖNLENDİRİCİ TAKIMI MS58 PİRİNÇTEN ÜRETİLMİŞTİR.
- TESİSAT BAĞLANTILARI G ½' DİR.
- EL DUŞU BAĞLANTISI G ½' DİR.

**Mix Bathroom Faucet**

- OUR PRODUCT IS MADE OF MS58/MS63 BRASS LOW PRESSURE INGOTS
- SURFACE COATING IS 0,16mm CHROME COATING
- OUTPUT LENGTH 150mm
- 40 BAR PRESSURE RESISTANT CERAMIC CARTRIDGE USED
- WATER FLOW IS BETWEEN 19 AND 23 PER MINUTE
- THE ROYTER TOOLS WAS MADE BRASS'S
- INSTALLATION CONNECTIONS ARE G ½
- HAND SHOWER CONNECTIONS ARE G ½

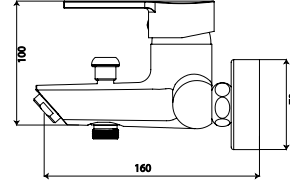
**Siyah**

12 | 2.250,00 ₺

Code: 45 2010 2214

**Mix Kuğu Mutfak Bataryası**

- ÜRÜNÜMÜZ MS58 PİRİNÇ MALZEMEDEN ÜRETİLMİŞTİR.
- YÜZEY KAPLAMASI 0,12 İLE 0,16 MİKRON KROM KAPLAMADIR.
- ÇIKIŞ UCU UZUNLUĞU 185 mm'DİR.
- ÇIKIŞ UCU YÜKSEKLİĞİ 345 mm'DİR.
- SU AKIŞ BORUSU ÇAPI 22mm, SU AKIŞ BORUSU MS63 PİRİNÇTİR.
- 360 DERECE DÖNER BORULUDUR.
- 40 BAR BASINCA DAYANIKLI SERAMİK KARTUŞ KULLANILMAKTADIR.
- PERLATÖRÜN SU AKIŞ DEBİSİ DAKİKADA12 İLE 18 lt ARASINDADIR.
- 3/8 M-10 40 BAR BASINCA DAYANIKLI ÇELİK ÖRGÜLÜ FLEX KULLANILMIŞTIR.

**Mix Kitchen Faucet**

- OUR PRODUCT IS MADE OF MS58 BRASS
- SURFACE COATING IS 0,16mm CHROME COATING
- OUTPUT LENGTH 185mm
- OUTPUT END PIPE HEIGHT IS 345mm
- THE DIAMETER FO THE PIPE IS 22, THE WATER FLOW PIPE MS63 IS BRASS
- 360 ROTARY PIPE
- 40 BAR PRESSURE RESISTANT CERAMIC CARTRIDGE USED
- WATER FLOW IS BETWEEN 13 AND 18 PER MINUTE
- G 3/8 M-10 40 BAR PRESSURE RESISTANT STEEL BRAIDED FLEX USED

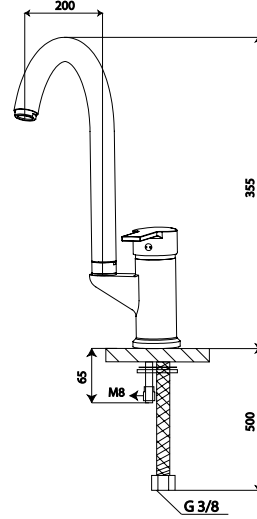
**Siyah**

12 | 1.625,00 ₺

Code: 45 2010 2216

**Mix Kuğu Lavabo Bataryası**

- ÜRÜNÜMÜZ MS58 PİRİNÇ MALZEMEDEN ÜRETİLMİŞTİR.
- YÜZEY KAPLAMASI 0,16 MİKRON KROM KAPLAMADIR.
- ÇIKIŞ UCU UZUNLUĞU 140 mm'DİR.
- ÇIKIŞ UCU YÜKSEKLİĞİ 270 mm'DİR.
- SU AKIŞ BORUSU ÇAPI 22mm, SU AKIŞ BORUSU MS63 PİRİNÇ.
- 360 DERECE DÖNER BORULUDUR.
- 40 BAR BASINCA DAYANIKLI SERAMİK KARTUŞ KULLANILMAKTADIR.
- PERLATÖRÜN SU AKIŞ DEBİSİ DAKİKADA12 İLE 18 lt ARASINDADIR.
- 3/8 M-10 40 BAR BASINCA DAYANIKLI ÇELİK ÖRGÜLÜ FLEX KULLANILMIŞTIR.

**Mix Basin Faucet**

- OUR PRODUCT IS MADE OF MS58 BRASS
- SURFACE COATING IS 0,16mm CHROME COATING
- OUTPUT LENGTH 140mm
- OUTPUT END PIPE HEIGHT IS 270mm
- THE DIAMETER FO THE PIPE IS 22, THE WATER FLOW PIPE MS63 IS BRASS
- 360 ROTARY PIPE
- 40 BAR PRESSURE RESISTANT CERAMIC CARTRIDGE USED
- WATER FLOW IS BETWEEN 13 AND 18 PER MINUTE
- G 3/8 M-10 40 BAR PRESSURE RESISTANT STEEL BRAIDED FLEX USED

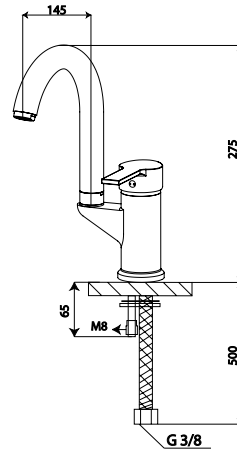
**Siyah**

12 | 1.625,00 ₺

Code: 45 2010 2217

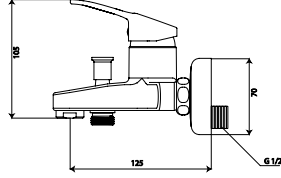

#### Mix Banyo Bataryası

- ÜRÜNÜMÜZ MS58 PİRİNÇ DÖKÜMDEN ÜRETİLMİŞTİR.
- YÜZEY KAPLAMASI 0,12 İLE 0,16 MİKRON KROM KAPLAMADIR.
- ÇIKIŞ UCU UZUNLUĞU 125 mm'DİR.
- 40 BAR BASINCA DAYANIKLI SERAMİK KARTUŞ KULLANILMAKTADIR.
- YÖNLENDİRİCİ TAKIMI MS58 PİRİNÇTEN ÜRETİLMİŞTİR.
- TESİSAT BAĞLANTILARI G ½' DİR.
- EL DUŞU BAĞLANTISI G ½' DİR.

#### Mix Bathroom Faucet

- OUR PRODUCT IS MADE OF FROM MS58 BRASS CASTING
- SURFACE COATING IS 0,16mm CHROME COATING
- OUTPUT LENGTH 125mm
- 40 BAR PRESSURE RESISTANT CERAMIC CARTRIDGE USED
- THE ROYTER TOOLS WAS MADE BRASS'S
- INSTALLATION CONNECTIONS ARE G ½
- HAND SHOWER CONNECTIONS ARE G ½

12 | 1.750,00 ₺

Code: 46 2010 1110

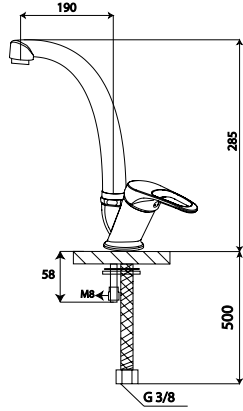

#### Mix Kuğu Mutfak Bataryası

- ÜRÜNÜMÜZ MS58 PİRİNÇ MALZEMEDEN ÜRETİLMİŞTİR.
- YÜZEY KAPLAMASI 0,12 İLE 0,16 MİKRON KROM KAPLAMADIR.
- ÇIKIŞ UCU UZUNLUĞU 190 mm'DİR.
- ÇIKIŞ UCU YÜKSEKLİĞİ 285 mm'DİR.
- SU AKIŞ BORUSU ÇAPI 22mm , SU AKIŞ BORUSU PASLANMAZDIR.
- 360 DERECE DÖNER BORULUDUR.
- 40 BAR BASINCA DAYANIKLI SERAMİK KARTUŞ KULLANILMAKTADIR.
- 3/8 M-10 40 BAR BASINCA DAYANIKLI ÇELİK ÖRGÜLÜ FLEX KULLANILMIŞTIR.

#### Mix Kitchen Faucet

- OUR PRODUCT IS MADE OF MS58 BRASS
- SURFACE COATING IS 0,16mm CHROME COATING
- OUTPUT LENGTH 190mm
- OUTPUT END PIPE HEIGHT IS 285mm
- THE DIAMETER FO THE PIPE IS 22, THE WATER FLOW PIPE STAINLESS
- 360 ROTARY PIPE
- 40 BAR PRESSURE RESISTANT CERAMIC CARTRIDGE USED
- G 3/8 M-10 40 BAR PRESSURE RESISTANT STEEL BRAIDED FLEX USED

12 | 900,00 ₺

Code: 46 2010 1111

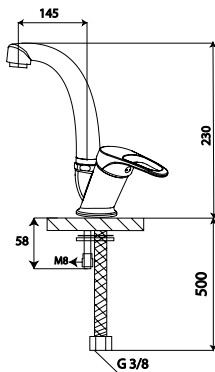

#### Mix Kuğu Lavabo Bataryası

- ÜRÜNÜMÜZ MS58 PİRİNÇ MALZEMEDEN ÜRETİLMİŞTİR.
- YÜZEY KAPLAMASI 0,12 İLE 0,16 MİKRON KROM KAPLAMADIR.
- ÇIKIŞ UCU UZUNLUĞU 145 mm'DİR.
- ÇIKIŞ UCU YÜKSEKLİĞİ 230mm'DİR.
- SU AKIŞ BORUSU ÇAPI 22mm , SU AKIŞ BORUSU PASLANMAZDIR.
- 360 DERECE DÖNER BORULUDUR.
- 40 BAR BASINCA DAYANIKLI SERAMİK KARTUŞ KULLANILMAKTADIR.
- 3/8 M-10 40 BAR BASINCA DAYANIKLI ÇELİK ÖRGÜLÜ FLEX KULLANILMIŞTIR.

#### Mix Basin Faucet

- OUR PRODUCT IS MADE OF MS58 BRASS
- SURFACE COATING IS 0,16mm CHROME COATING
- OUTPUT LENGTH 145mm
- OUTPUT END PIPE HEIGHT IS 2mm
- THE DIAMETER FO THE PIPE IS 22, THE WATER FLOW PIPE STAINLESS
- 360 ROTARY PIPE
- 40 BAR PRESSURE RESISTANT CERAMIC CARTRIDGE USED
- G 3/8 M-10 40 BAR PRESSURE RESISTANT STEEL BRAIDED FLEX USED

12 | 900,00 ₺

Code: 46 2010 1112

**Mix Banyo Bataryası**

- ÜRÜNÜMÜZ MS58 PİRİNÇ DÖKÜMDEN ÜRETİLMİŞTİR.
- YÜZEY KAPLAMASI 0,12 İLE 0,16 MİKRON KROM KAPLAMADIR.
- ÇIKIŞ UCU UZUNLUĞU 125 mm'DİR.
- 40 BAR BASINCA DAYANIKLI SERAMİK KARTUŞ KULLANILMAKTADIR.
- YÖNLENDİRİCİ TAKIMI MS58 PİRİNÇTEN ÜRETİLMİŞTİR.
- TESİSAT BAĞLANTILARI G ½' DİR.
- EL DUŞU BAĞLANTISI G ½' DİR.

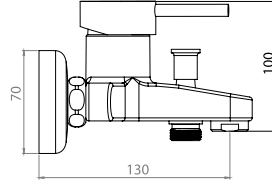
**Mix Bathroom Faucet**

- OUR PRODUCT IS MADE OF FROM MS58 BRASS CASTING
- SURFACE COATING IS 0,16mm CHROME COATING
- OUTPUT LENGTH 125mm
- 40 BAR PRESSURE RESISTANT CERAMIC CARTRIDGE USED
- THE ROYTER TOOLS WAS MADE BRASS'S
- INSTALLATION CONNECTIONS ARE G ½
- HAND SHOWER CONNECTIONS ARE G ½

 **Siyah**

 12 | **2.150,00 ₺**

Code: 46 2010 1140

**Mix Kuğu Mutfak Bataryası**

- ÜRÜNÜMÜZ MS58 PİRİNÇ MALZEMEDEN ÜRETİLMİŞTİR.
- YÜZEY KAPLAMASI 0,12 İLE 0,16 MİKRON KROM KAPLAMADIR.
- ÇIKIŞ UCU UZUNLUĞU 190 mm'DİR.
- ÇIKIŞ UCU YÜKSEKLİĞİ 285 mm'DİR.
- SU AKIŞ BORUSU ÇAPİ 22mm , SU AKIŞ BORUSU PASLANMAZDIR.
- 360 DERECE DÖNER BORULUDUR.
- 40 BAR BASINCA DAYANIKLI SERAMİK KARTUŞ KULLANILMAKTADIR.
- 3/8 M-10 40 BAR BASINCA DAYANIKLI ÇELİK ÖRGÜLÜ FLEX KULLANILMIŞTIR.

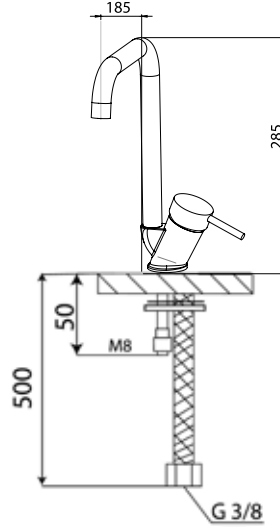
**Mix Kitchen Faucet**

- OUR PRODUCT IS MADE OF MS58 BRASS
- SURFACE COATING IS 0,16mm CHROME COATING
- OUTPUT LENGTH 190mm
- OUTPUT END PIPE HEIGHT IS 285mm
- THE DIAMETER FO THE PIPE IS 22, THE WATER FLOW PIPE STAINLESS
- 360 ROTARY PIPE
- 40 BAR PRESSURE RESISTANT CERAMIC CARTRIDGE USED
- G 3/8 M-10 40 BAR PRESSURE RESISTANT STEEL BRAIDED FLEX USED

 **Siyah**

 12 | **1.150,00 ₺**

Code: 46 2010 1141

**Mix Lavabo Bataryası**

- ÜRÜNÜMÜZ MS58/MS63 ORANINDA ALÇAK BASINÇ PİRİNÇ KÜLÇEDEN ÜRETİLMİŞTİR.
- YÜZEY KAPLAMASI 0,12 İLE 0,16 MİKRON KROM KAPLAMADIR.
- ÇIKIŞ UCU UZUNLUĞU 145 mm'DİR.
- ÜRÜN YÜKSEKLİĞİ 120 mm'DİR.
- 40 BAR BASINCA DAYANIKLI SERAMİK KARTUŞ KULLANILMAKTADIR.
- PERLATÖRÜN SU AKIŞ DEBİSİ DAKİKADA19 İLE 23 lt ARASINDADIR.
- 3/8 M-10 40 BAR BASINCA DAYANIKLI ÇELİK ÖRGÜLÜ FLEX KULLANILMIŞTIR.

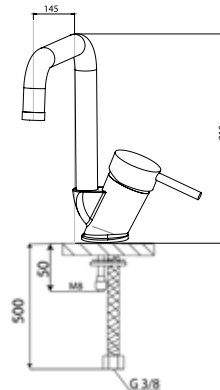
**Mix Basin Faucet**

- OUR PRODUCT IS MADE OF MS58/MS63 BRASS LOW PRESSURE INGOTS
- SURFACE COATING IS 0,16mm CHROME COATING
- OUTPUT LENGTH 145 mm
- PRODUCT HEIGHT 120 mm
- 40 BAR PRESSURE RESISTANT CERAMIC CARTRIDGE USED
- WATER FLOW IS BETWEEN 19 AND 23 PER MINUTE
- G 3/8 M-10 40 BAR PRESSURE RESISTANT STEEL BRAIDED FLEX USED

 **Siyah**

 12 | **1.150,00 ₺**

Code: 46 2010 1142

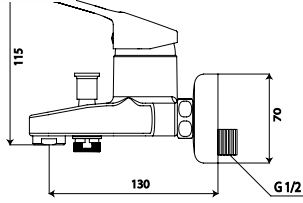

### Mix Banyo Bataryası

- ÜRÜNÜMÜZ MS58 PİRİNÇ DÖKÜMDEN ÜRETİLMİŞTİR.
- YÜZEY KAPLAMASI 0,12 İLE 0,16 MİKRON KROM KAPLAMADIR.
- ÇIKIŞ UCU UZUNLUĞU 130 mm'DİR.
- 40 BAR BASINCA DAYANIKLI SERAMİK KARTUŞ KULLANILMAKTADIR.
- YÖNLENDİRİCİ TAKIMI MS58 PİRİNÇTEN ÜRETİLMİŞTİR.
- TESİSAT BAĞLANTILARI G ½' DİR.
- EL DUŞU BAĞLANTISI G ½' DİR.

### Mix Bathroom Faucet

- OUR PRODUCT IS MADE OF FROM MS58 BRASS CASTING
- SURFACE COATING IS 0,16mm CHROME COATING
- OUTPUT LENGTH 130mm
- 40 BAR PRESSURE RESISTANT CERAMIC CARTRIDGE USED
- THE ROYTER TOOLS WAS MADE BRASS'S
- INSTALLATION CONNECTIONS ARE G ½
- HAND SHOWER CONNECTIONS ARE G ½

12 | 1.750,00 ₺  
Code: 46 2010 1113

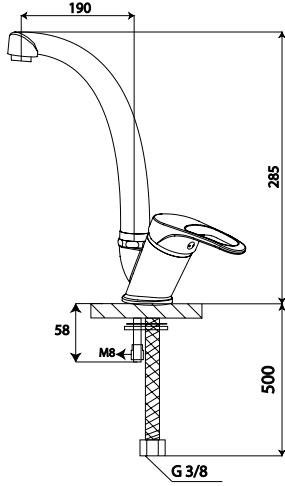

### Mix Kuğu Mutfak Bataryası

- ÜRÜNÜMÜZ MS58 PİRİNÇ MALZEMEDEN ÜRETİLMİŞTİR.
- YÜZEY KAPLAMASI 0,12 İLE 0,16 MİKRON KROM KAPLAMADIR.
- ÇIKIŞ UCU UZUNLUĞU 190 mm'DİR.
- ÇIKIŞ UCU YÜKSEKLİĞİ 285 mm'DİR.
- SU AKIŞ BORUSU ÇAPI 22mm , SU AKIŞ BORUSU PASLANMAZDIR.
- 360 DERECE DÖNER BORULUDUR.
- 40 BAR BASINCA DAYANIKLI SERAMİK KARTUŞ KULLANILMAKTADIR.
- 3/8 M-10 40 BAR BASINCA DAYANIKLI ÇELİK ÖRGÜLÜ FLEX KULLANILMIŞTIR.

### Mix Kitchen Faucet

- OUR PRODUCT IS MADE OF MS58 BRASS
- SURFACE COATING IS 0,16mm CHROME COATING
- OUTPUT LENGTH 190mm
- OUTPUT END PIPE HEIGHT IS 285mm
- THE DIAMETER FO THE PIPE IS 22, THE WATER FLOW PIPE STAINLESS
- 360 ROTARY PIPE
- 40 BAR PRESSURE RESISTANT CERAMIC CARTRIDGE USED
- G 3/8 M-10 40 BAR PRESSURE RESISTANT STEEL BRAIDED FLEX USED

12 | 900,00 ₺  
Code: 46 2010 1114

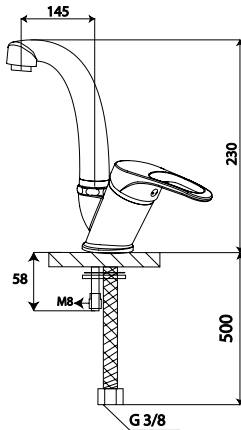

### Mix Kuğu Lavabo Bataryası

- ÜRÜNÜMÜZ MS58 PİRİNÇ MALZEMEDEN ÜRETİLMİŞTİR.
- YÜZEY KAPLAMASI 0,12 İLE 0,16 MİKRON KROM KAPLAMADIR.
- ÇIKIŞ UCU UZUNLUĞU 145 mm'DİR.
- ÇIKIŞ UCU YÜKSEKLİĞİ 230mm'DİR.
- SU AKIŞ BORUSU ÇAPI 22mm , SU AKIŞ BORUSU PASLANMAZDIR.
- 360 DERECE DÖNER BORULUDUR.
- 40 BAR BASINCA DAYANIKLI SERAMİK KARTUŞ KULLANILMAKTADIR.
- 3/8 M-10 40 BAR BASINCA DAYANIKLI ÇELİK ÖRGÜLÜ FLEX KULLANILMIŞTIR.

### Mix Basin Faucet

- OUR PRODUCT IS MADE OF MS58 BRASS
- SURFACE COATING IS 0,16mm CHROME COATING
- OUTPUT LENGTH 145mm
- OUTPUT END PIPE HEIGHT IS 2mm
- THE DIAMETER FO THE PIPE IS 22, THE WATER FLOW PIPE STAINLESS
- 360 ROTARY PIPE
- 40 BAR PRESSURE RESISTANT CERAMIC CARTRIDGE USED
- G 3/8 M-10 40 BAR PRESSURE RESISTANT STEEL BRAIDED FLEX USED

12 | 900,00 ₺  
Code: 46 2010 1115

### Mix Banyo Bataryası

- ÜRÜNÜMÜZ MS58 PİRİNÇ DÖKÜMDEN ÜRETİLMİŞTİR.
- YÜZEY KAPLAMASI 0,12 İLE 0,16 MİKRON KROM KAPLAMADIR.
- ÇIKIŞ UCU UZUNLUĞU 130 mm'DİR.
- 40 BAR BASINCA DAYANIKLI SERAMİK KARTUŞ KULLANILMAKTADIR.
- YÖNLENDİRİCİ TAKIMI MS58 PİRİNÇTEN ÜRETİLMİŞTİR.
- TESİSAT BAĞLANTILARI G ½' DİR.
- EL DUŞU BAĞLANTISI G ½' DİR.

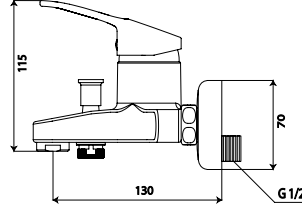

### Mix Bathroom Faucet

- OUR PRODUCT IS MADE OF FROM MS58 BRASS CASTING
- SURFACE COATING IS 0,16mm CHROME COATING
- OUTPUT LENGTH 130mm
- 40 BAR PRESSURE RESISTANT CERAMIC CARTRIDGE USED
- THE ROYTER TOOLS WAS MADE BRASS'S
- INSTALLATION CONNECTIONS ARE G ½
- HAND SHOWER CONNECTIONS ARE G ½

12 | 1.750,00 ₺  
Code: 46 2010 1120

### Mix Baston Boru Mutfak Bataryası

- ÜRÜNÜMÜZ MS58 PİRİNÇ MALZEMEDEN ÜRETİLMİŞTİR.
- YÜZEY KAPLAMASI 0,12 İLE 0,16 MİKRON KROM KAPLAMADIR.
- ÇIKIŞ UCU UZUNLUĞU 180 mm'DİR.
- ÇIKIŞ UCU YÜKSEKLİĞİ 310 mm'DİR.
- SU AKIŞ BORUSU ÇAPI 22mm . SU AKIŞ BORUSU PASLANMAZDIR.
- 360 DERECE DÖNER BORULUDUR.
- 40 BAR BASINCA DAYANIKLI SERAMİK KARTUŞ KULLANILMAKTADIR.
- 3/8 M-10 40 BAR BASINCA DAYANIKLI ÇELİK ÖRGÜLÜ FLEX KULLANILMIŞTIR.

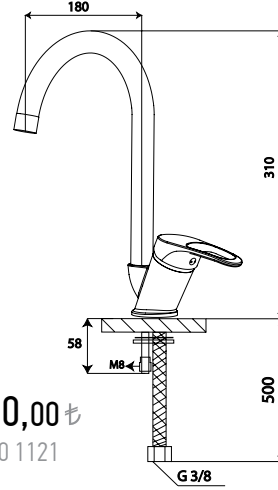

### Mix Kitchen Faucet

- OUR PRODUCT IS MADE OF MS58 BRASS
- SURFACE COATING IS 0,16mm CHROME COATING
- OUTPUT LENGTH 180mm
- OUTPUT END PIPE HEIGHT IS 310mm
- THE DIAMETER FO THE PIPE IS 22, THE WATER FLOW PIPE STAINLESS
- 360 ROTARY PIPE
- 40 BAR PRESSURE RESISTANT CERAMIC CARTRIDGE USED
- G 3/8 M-10 40 BAR PRESSURE RESISTANT STEEL BRAIDED FLEX USED

12 | 950,00 ₺  
Code: 46 2010 1121

### Mix Baston Boru Lavabo Bataryası

- ÜRÜNÜMÜZ MS58 PİRİNÇ MALZEMEDEN ÜRETİLMİŞTİR.
- YÜZEY KAPLAMASI 0,12 İLE 0,16 MİKRON KROM KAPLAMADIR.
- ÇIKIŞ UCU UZUNLUĞU 135 mm'DİR.
- ÇIKIŞ UCU YÜKSEKLİĞİ 230mm'DİR.
- SU AKIŞ BORUSU ÇAPI 22mm . SU AKIŞ BORUSU PASLANMAZDIR.
- 360 DERECE DÖNER BORULUDUR.
- 40 BAR BASINCA DAYANIKLI SERAMİK KARTUŞ KULLANILMAKTADIR.
- 3/8 M-10 40 BAR BASINCA DAYANIKLI ÇELİK ÖRGÜLÜ FLEX KULLANILMIŞTIR.

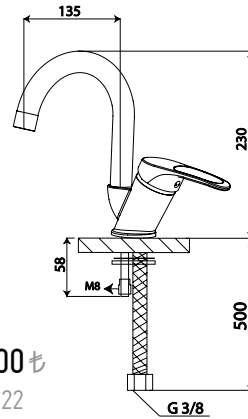

### Mix Basin Faucet

- OUR PRODUCT IS MADE OF MS58 BRASS
- SURFACE COATING IS 0,16mm CHROME COATING
- OUTPUT LENGTH 135mm
- OUTPUT END PIPE HEIGHT IS 230mm
- THE DIAMETER FO THE PIPE IS 22, THE WATER FLOW PIPE STAINLESS
- 360 ROTARY PIPE
- 40 BAR PRESSURE RESISTANT CERAMIC CARTRIDGE USED
- G 3/8 M-10 40 BAR PRESSURE RESISTANT STEEL BRAIDED FLEX USED

12 | 950,00 ₺  
Code: 46 2010 1122

**Uzun Musluk**

- MS58 KAPALI SİSTEM G1/2 SALMASTRA KULLANILMIŞTIR.
- ÇIKIŞ UCU UZUNLUĞU 125 mm'DİR.
- TESİSAT BAĞLANTILARI G 1/2' DİR.

**Long Tap**

- MS58 OFF SYSTEM G1/2 CARTRIDGE
- OUTPUT LENGTH 125mm
- INSTALLATION CONNECTIONS ARE G 1/2

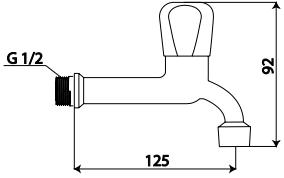

60 | 305,00 ₺  
Code: 46 2010 1101

**Kısa Musluk**

- MS58 KAPALI SİSTEM G1/2 SALMASTRA KULLANILMIŞTIR.
- ÇIKIŞ UCU UZUNLUĞU 90 mm'DİR.
- TESİSAT BAĞLANTILARI G 1/2' DİR.

**Short Tap**

- MS58 OFF SYSTEM G1/2 CARTRIDGE
- OUTPUT LENGTH 90mm
- INSTALLATION CONNECTIONS ARE G 1/2

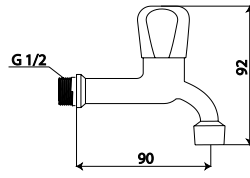

60 | 305,00 ₺  
Code: 46 2010 1102

**Çamaşır Musluğu**

- MS58 KAPALI SİSTEM G1/2 SALMASTRA KULLANILMIŞTIR.
- ÇIKIŞ UCU UZUNLUĞU 125 mm'DİR.
- TESİSAT BAĞLANTILARI G 1/2' DİR.

**Laundry Tap**

- MS58 OFF SYSTEM G1/2 CARTRIDGE
- OUTPUT LENGTH 125mm
- INSTALLATION CONNECTIONS ARE G 1/2

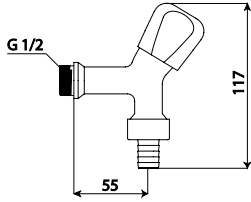

60 | 325,00 ₺  
Code: 46 2010 1103

**Musluk Bası Takımı  
Faucet Knob Set**

150 | 130,00 ₺  
Code: 46 2010 1107

**Musluk Volanı  
Faucet Knob**

150 | 40,00 ₺  
Code: 46 2010 1104

**Salmastra  
Seal**

200 | 98,00 ₺  
Code: 46 2010 1105





### Pirinç Uzun Musluk

- ÜRÜNÜMÜZ MS58 MALZEMEDEN ÜRETİLMİŞTİR.
- YÜZEY KAPLAMASI 0,12 İLE 0,16 MİKRON KROM KAPLAMADIR.
- MS58 KAPALI SİSTEM G1/2 SALMASTRA KULLANILMIŞTIR.
- PİRİNÇ BAŞLIK KULLANILMIŞTIR.
- ÇIKIŞ UCU UZUNLUĞU 120 mm'DİR.
- TESİSAT BAĞLANTILARI G 1/2' DİR.

### Brass Long Tap

- OUR PRODUCT IS MADE OF MS58 BRASS
- SURFACE COATING IS 0,16mm CHROME COATING
- MS58 OFF SYSTEM G1/2 CARTRIDGE
- BRASS HEADGEAR HAS BEEN USED
- OUTPUT LENGTH 120mm
- INSTALLATION CONNECTIONS ARE G 1/2

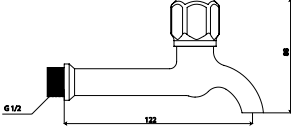

50 | 550,00 ₺  
Code: 47 2010 1265



### Pirinç Kısa Musluk

- ÜRÜNÜMÜZ MS58 MALZEMEDEN ÜRETİLMİŞTİR.
- YÜZEY KAPLAMASI 0,12 İLE 0,16 MİKRON KROM KAPLAMADIR.
- MS58 KAPALI SİSTEM G1/2 SALMASTRA KULLANILMIŞTIR.
- PİRİNÇ BAŞLIK KULLANILMIŞTIR.
- ÇIKIŞ UCU UZUNLUĞU 85 mm'DİR.
- TESİSAT BAĞLANTILARI G 1/2' DİR.

### Brass Short Tap

- OUR PRODUCT IS MADE OF MS58 BRASS
- SURFACE COATING IS 0,16mm CHROME COATING
- MS58 OFF SYSTEM G1/2 CARTRIDGE
- BRASS HEADGEAR HAS BEEN USED
- OUTPUT LENGTH 85mm
- INSTALLATION CONNECTIONS ARE G 1/2

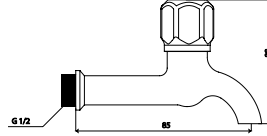

50 | 550,00 ₺  
Code: 47 2010 1266



### Pirinç Çamaşır Musluk

- ÜRÜNÜMÜZ MS58 MALZEMEDEN ÜRETİLMİŞTİR.
- YÜZEY KAPLAMASI 0,12 İLE 0,16 MİKRON KROM KAPLAMADIR.
- MS58 KAPALI SİSTEM G1/2 SALMASTRA KULLANILMIŞTIR.
- PİRİNÇ BAŞLIK KULLANILMIŞTIR.
- ÇIKIŞ UCU UZUNLUĞU 120 mm'DİR.
- TESİSAT BAĞLANTILARI G 1/2' DİR.

### Brass Laundry Tap

- OUR PRODUCT IS MADE OF MS58 BRASS
- SURFACE COATING IS 0,16mm CHROME COATING
- MS58 OFF SYSTEM G1/2 CARTRIDGE
- BRASS HEADGEAR HAS BEEN USED
- OUTPUT LENGTH 120mm
- INSTALLATION CONNECTIONS ARE G 1/2

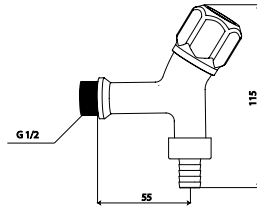

50 | 560,00 ₺  
Code: 47 2010 1267



### Pirinç Musluk Başı Takımı

- ÜRÜNÜMÜZ MS58 MALZEMEDEN ÜRETİLMİŞTİR.
- YÜZEY KAPLAMASI 0,12 İLE 0,16 MİKRON KROM KAPLAMADIR.
- MS58 KAPALI SİSTEM G1/2 SALMASTRA KULLANILMIŞTIR.
- PİRİNÇ BAŞLIK KULLANILMIŞTIR.

### Brass Short Tap

- OUR PRODUCT IS MADE OF MS58 BRASS
- SURFACE COATING IS 0,16mm CHROME COATING
- MS58 OFF SYSTEM G1/2 CARTRIDGE
- BRASS HEADGEAR HAS BEEN USED

150 | 220,00 ₺  
Code: 47 2010 1268

## 35'lik ve 40'lik Ayaklı Ayaksız Mix Kartuşları



Ayaklı

Code: 44 2010 0964

**Mix Aç-Kapa Kartuşu 35'lik**

Code: 44 2010 0938

**Mix Aç-Kapa Kartuşu 40'lik**

150 | 160,00 ₺



Ayaksız

Code: 44 2010 0976

**Mix Aç-Kapa Kartuşu 35'lik**

Code: 44 2010 0936

**Mix Aç-Kapa Kartuşu 40'lik**

150 | 160,00 ₺



Ayaklı

Code: 44 2010 1001

**Mix Aç-Kapa Kartuşu 25'lik**

150 | 120,00 ₺



Ayaksız

Code: 44 2010 1000

**Mix Aç-Kapa Kartuşu 25'lik**

150 | 120,00 ₺



Basmalı Zaman Ayarlı  
Lavabo Bataryası  
Push System Time Adjustment  
Basin Faucet

30 | 3.960,00 ₺  
Code: 35 2010 5905



Sebil Basmalı Lavabo Bataryası  
Push System Basin Faucet

30 | 5.460,00 ₺  
Code: 35 2010 5906

### Mix Lavabo Bataryası

- ÇIKIŞ UCU UZUNLUĞU 70 mm'DİR.
- ÜRÜN YÜKSEKLİĞİ 160 mm'DİR.
- 3/8 M-10 40 BAR BASINCA DAYANIKLI ÇELİK ÖRGÜLÜ FLEX KULLANILMIŞTIR.

### Mix Basın Faucet

- OUTPUT LENGTH 70 mm
- PRODUCT HEIGHT 160 mm
- G 3/8 M-10 40 BAR PRESSURE RESISTANT STEEL BRAIDED FLEX USED

12 | 1.490,00 ₺  
Code: 46 2010 1119

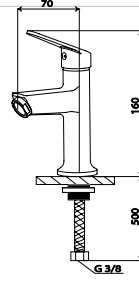

### Mix Tek Çıkışlı Kuğu Lavabo Bataryası

- ÜRÜNÜMÜZ MS58 PİRİNÇ MALZEMEDEN ÜRETİLMİŞTİR.
- YÜZEY KAPLAMASI 0,12 İLE 0,16 MİKRON KROM KAPLAMADIR.
- ÇIKIŞ UCU UZUNLUĞU 145 mm'DİR.
- ÇIKIŞ UCU YÜKSEKLİĞİ 200 mm'DİR.
- SU AKIŞ BORUSU ÇAPI 22mm , SU AKIŞ BORUSU PASLANMAZDIR.
- 360 DERECE DÖNER BORULUDUR.
- 40 BAR BASINCA DAYANIKLI SERAMİK KARTUŞ KULLANILMAKTADIR.
- 3/8 M-10 40 BAR BASINCA DAYANIKLI ÇELİK ÖRGÜLÜ FLEX KULLANILMIŞTIR.

### Mix Single Output Swan Basin Faucet

- OUR PRODUCT IS MADE OF MS58 BRASS
- SURFACE COATING IS 0,16mm CHROME COATING
- OUTPUT LENGTH 145mm
- OUTPUT END PIPE HEIGHT IS 200mm
- THE DIAMETER FO THE PIPE IS 22, THE WATER FLOW PIPE STANINLESS
- 360 ROTARY PIPE
- 40 BAR PRESSURE RESISTANT CERAMIC CARTRIDGE USED
- G 3/8 M-10 40 BAR PRESSURE RESISTANT STEEL BRAIDED FLEX USED

12 | 1.190,00 ₺  
Code: 43 2010 0889

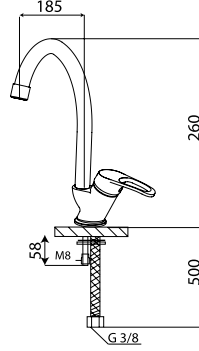

### Mix Tek Çıkışlı Mermer Üstü Lavabo Bataryası

- ÜRÜNÜMÜZ MS58 PİRİNÇ MALZEMEDEN ÜRETİLMİŞTİR.
- YÜZEY KAPLAMASI 0,12 İLE 0,16 MİKRON KROM KAPLAMADIR.
- ÇIKIŞ UCU UZUNLUĞU 130 mm'DİR.
- ÇIKIŞ UCU YÜKSEKLİĞİ 230 mm'DİR.
- SU AKIŞ BORUSU ÇAPI 22mm , SU AKIŞ BORUSU MS63 PİRİNÇTİR.
- 360 DERECE DÖNER BORULUDUR.
- 40 BAR BASINCA DAYANIKLI SERAMİK KARTUŞ KULLANILMAKTADIR.
- 3/8 M-10 40 BAR BASINCA DAYANIKLI ÇELİK ÖRGÜLÜ FLEX KULLANILMIŞTIR.

### Mix Single Output Basin Faucet

- OUR PRODUCT IS MADE OF MS58 BRASS
- SURFACE COATING IS 0,16mm CHROME COATING
- OUTPUT LENGTH 130mm
- OUTPUT END PIPE HEIGHT IS 230mm
- THE DIAMETER FO THE PIPE IS 22, THE WATER FLOW PIPE MS63 IS BRASS
- 360 ROTARY PIPE
- 40 BAR PRESSURE RESISTANT CERAMIC CARTRIDGE USED
- G 3/8 M-10 40 BAR PRESSURE RESISTANT STEEL BRAIDED FLEX USED

12 | 1.210,00 ₺  
Code: 43 2010 0809

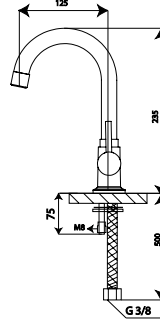

### Mix Tek Çıkışlı Duvardan Mutfak Bataryası

- ÜRÜNÜMÜZ MS58 PİRİNÇ MALZEMEDEN ÜRETİLMİŞTİR.
- YÜZEY KAPLAMASI 0,12 İLE 0,16 MİKRON KROM KAPLAMADIR.
- ÇIKIŞ UCU UZUNLUĞU 155 mm'DİR.
- ÇIKIŞ UCU YÜKSEKLİĞİ 210 mm'DİR.
- SU AKIŞ BORUSU ÇAPI 22mm , SU AKIŞ BORUSU PASLANMAZDIR.
- 360 DERECE DÖNER BORULUDUR.
- 40 BAR BASINCA DAYANIKLI SERAMİK

### Mix Wall Mounted Single Output Kitchen Faucet

- OUR PRODUCT IS MADE OF MS58 BRASS
- SURFACE COATING IS 0,16mm CHROME COATING
- OUTPUT LENGTH 155mm
- OUTPUT END PIPE HEIGHT IS 210mm
- THE DIAMETER FO THE PIPE IS 22, THE WATER FLOW PIPE STAINLESS
- 360 ROTARY PIPE
- 40 BAR PRESSURE RESISTANT CERAMIC CARTRIDGE USED
- INSTALLATION CONNECTIONS ARE G 1/2

12 | 995,00 ₺  
Code: 43 2010 0810

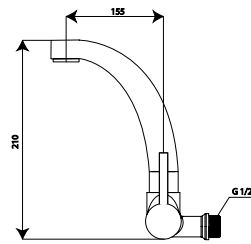

	<b>Krom</b> Code: 47 2010 1211	34	600,00 ₺
	<b>Beyaz</b> Code: 47 2010 1212	34	750,00 ₺
	<b>Mat Siyah</b> Code: 47 2010 1213	34	750,00 ₺
	<b>Kırmızı</b> Code: 47 2010 1214	34	750,00 ₺
	<b>Altın</b> Code: 47 2010 1215	34	900,00 ₺

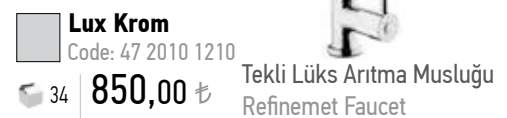

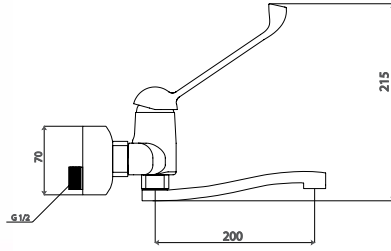

### Mix Duvardan Döner Mutfak Bataryası

- ÇIKIŞ UCU UZUNLUĞU 200 mm'DİR.
- 40 BAR BASINCA DAYANIKLI SERAMİK KARTUŞ KULLANILMAKTADIR.
- TESİSAT BAĞLANTILARI G ½' DİR.

### Mix Wall Mounted Rotating Kitchen Faucet

- OUTPUT LENGTH 200mm
- 40 BAR PRESSURE RESISTANT CERAMIC CARTRIDGE USED
- INSTALLATION CONNECTIONS ARE G ½

12 | 1.900,00 ₺  
Code: 31 2010 0220

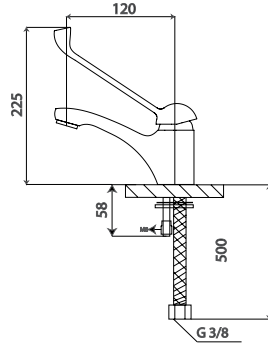

### Mix Lavabo Bataryası

- ÇIKIŞ UCU UZUNLUĞU 1 mm'DİR.
- ÜRÜN YÜKSEKLİĞİ 165 mm'DİR.
- 40 BAR BASINCA DAYANIKLI SERAMİK KARTUŞ KULLANILMAKTADIR.
- 3/8 M-10 40 BAR BASINCA DAYANIKLI ÇELİK ÖRGÜLÜ FLEX KULLANILMIŞTIR.

### Mix Basın Faucet

- OUTPUT LENGTH 125 mm
- PRODUCT HEIGHT 165 mm
- 40 BAR PRESSURE RESISTANT CERAMIC CARTRIDGE USED
- G 3/8 M-10 40 BAR PRESSURE RESISTANT STEEL BRAIDED FLEX USED

12 | 1.600,00 ₺  
Code: 31 2010 0221

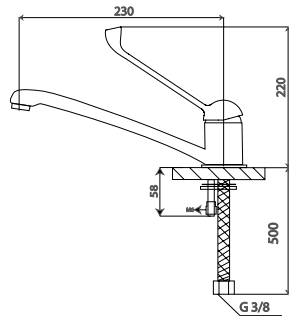

### Mix Kuğu Döner Mutfak Bataryası

- ÇIKIŞ UCU UZUNLUĞU 230 mm'DİR.
- ÜRÜN YÜKSEKLİĞİ 220 mm'di r.
- 360 DERECE DÖNER BORULUDUR.
- 40 BAR BASINCA DAYANIKLI SERAMİK KARTUŞ KULLANILMAKTADIR.
- 3/8 M-10 40 BAR BASINCA DAYANIKLI ÇELİK ÖRGÜLÜ FLEX KULLANILMIŞTIR.

### Mix Rotating Kitchen Faucet

- OUTPUT LENGTH 230mm
- PRODUCT HEIGHT IS 220mm
- 360 ROTARY PIPE
- 40 BAR PRESSURE RESISTANT CERAMIC CARTRIDGE USED
- G 3/8 M-10 40 BAR PRESSURE RESISTANT STEEL BRAIDED FLEX USED

12 | 2.400,00 ₺  
Code: 31 2010 0222

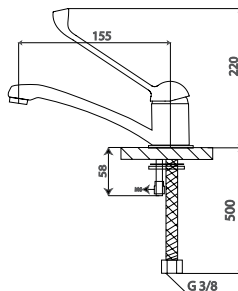

### Mix Kuğu Döner Lavabo Bataryası

- ÇIKIŞ UCU UZUNLUĞU 155 mm'DİR.
- ÜRÜN YÜKSEKLİĞİ 220 mm'di r.
- 360 DERECE DÖNER BORULUDUR.
- 40 BAR BASINCA DAYANIKLI SERAMİK KARTUŞ KULLANILMAKTADIR.
- 3/8 M-10 40 BAR BASINCA DAYANIKLI ÇELİK ÖRGÜLÜ FLEX KULLANILMIŞTIR.

### Mix Rotating Basin Faucet

- OUTPUT LENGTH 155mm
- PRODUCT HEIGHT IS 220mm
- 360 ROTARY PIPE
- 40 BAR PRESSURE RESISTANT CERAMIC CARTRIDGE USED
- G 3/8 M-10 40 BAR PRESSURE RESISTANT STEEL BRAIDED FLEX USED

12 | 2.400,00 ₺  
Code: 31 2010 0223

**Tek Pedallı Tek Su Çıkışı**  
Single Pedal Single Output Faucet

1 | 5.800,00 ₺  
Code: 31 2010 0224



**Tek Pedallı Çift Su Çıkışı**  
Single Pedal Dual Output Faucet

1 | 7.600,00 ₺  
Code: 31 2010 0225



**Çift Pedallı Çift Su Çıkışı**  
Double Pedal Dual Output Faucet

1 | 13.800,00 ₺  
Code: 31 2010 0226





Code: 48 2010 1301

**Antik Osmanlı Banyo Bataryası**  
**Antique Ottoman Bathroom Faucet**

4 5.150,00 ₺



Code: 48 2010 1302

**Antik Osmanlı Duvardan 360° Döner Mutfak Bataryası**  
**Antique Ottoman Wall Mounted 360° Rotating Kitchen Faucet**

4 4.600,00 ₺



Code: 48 2010 1303

**Antik Osmanlı 360° Kuğu Döner Mutfak Bataryası**  
**Antique Ottoman 360° Rotating Kitchen Faucet**

4 6.100,00 ₺



Code: 48 2010 1304

**Antik Osmanlı Kartal Lavabo Bataryası**  
**Antique Ottoman Eagle Basin Faucet**

4 5.150,00 ₺



Code: 48 2010 1305

**Antik Osmanlı Uzun Musluk**  
Antique Ottoman Long Tap



4

1.350,00 ₺



Code: 48 2010 1306

**Antik Osmanlı Kısa Musluk**  
Antique Ottoman Long Tap



4

1.350,00 ₺



Code: 48 2010 1307

**Antik Osmanlı Çamaşır Musluğu**  
Antique Ottoman Laundry Tap



4

1.625,00 ₺



Code: 48 2010 1308

**Antik Osmanlı 1/2 Taharet Musluğu**  
Antique Ottoman 1/2 Bidet Tap



4

1.250,00 ₺



Code: 48 2010 1311

**Antik Osmanlı Mafsallı Duş Seti**  
Antique Ott. Wall Bracket Shower Set



4

5.150,00 ₺



Code: 48 2010 1309

**Antik Osmanlı Musluğu**  
Antique Ottoman Tap



4

1.350,00 ₺

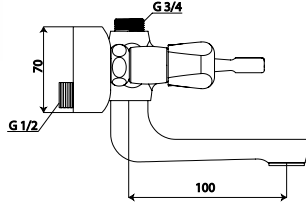

### Banyo Bataryası

- ÜRÜNÜMÜZ MS58/MS63 ORANINDA ALÇAK BASINÇ PİRİNÇ KÜLÇEDEN ÜRETİLMİŞTİR.
- YÜZEY KAPLAMASI 0,12 İLE 0,16 MİKRON KROM KAPLAMADIR.
- ÇIKIŞ UCU UZUNLUĞU 100 mm'DİR.
- TESİSAT BAĞLANTILARI G ½' DİR.
- EL DUŞU BAĞLANTISI G 3/4' DİR.

### Bathroom Faucet

- OUR PRODUCT IS MADE OF MS58/MS63 BRASS LOW PRESSURE INGOTS
- SURFACE COATING IS 0,16mm CHROME COATING
- OUTPUT LENGTH 100mm
- INSTALLATION CONNECTIONS ARE G ½
- HAND SHOWER CONNECTIONS ARE G 3/4

12 | 2.300,00 ₺  
Code: 44 2010 0901

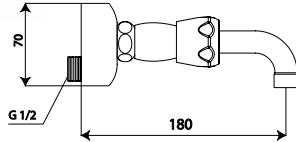

### Duvardan Sabit Lavabo Bataryası

- ÜRÜNÜMÜZ MS58/MS63 ORANINDA ALÇAK BASINÇ PİRİNÇ KÜLÇEDEN ÜRETİLMİŞTİR.
- YÜZEY KAPLAMASI 0,16 MİKRON KROM KAPLAMADIR.
- ÇIKIŞ UCU UZUNLUĞU 180 mm'DİR.
- TESİSAT BAĞLANTILARI G ½' DİR.

### Wall Mounted Fixed Basin Mixer

- OUR PRODUCT IS MADE OF MS58/MS63 BRASS LOW PRESSURE INGOTS
- SURFACE COATING IS 0,16mm CHROME COATING
- OUTPUT LENGTH 180mm
- INSTALLATION CONNECTIONS ARE G ½

12 | 1.800,00 ₺  
Code: 44 2010 0905

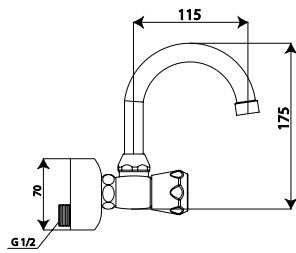

### Duvardan Döner Lavabo Bataryası

- ÜRÜNÜMÜZ MS58/MS63 ORANINDA ALÇAK BASINÇ PİRİNÇ KÜLÇEDEN ÜRETİLMİŞTİR.
- YÜZEY KAPLAMASI 0,16 MİKRON KROM KAPLAMADIR.
- SU AKIŞ BORUSU ÇAPI 18mm , SU AKIŞ BORUSU MS63 PİRİNÇTİR.
- ÇIKIŞ UCU UZUNLUĞU 115 mm'DİR.
- TESİSAT BAĞLANTILARI G ½' DİR.

### Wall Mounted Rotating Basin Faucet

- OUR PRODUCT IS MADE OF MS58/MS63 BRASS LOW PRESSURE INGOTS
- SURFACE COATING IS 0,16mm CHROME COATING
- THE DIAMETER FO THE PIPE IS 18, THE WATER FLOW PIPE MS63 IS BRASS
- OUTPUT LENGTH 115 mm
- INSTALLATION CONNECTIONS ARE G ½

12 | 1.800,00 ₺  
Code: 44 2010 0908

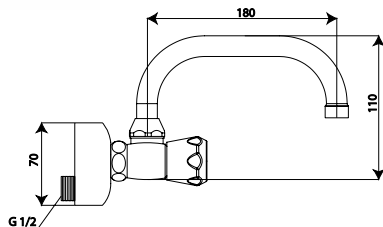

### Duvardan Döner Mutfak Bataryası

- ÜRÜNÜMÜZ MS58/MS63 ORANINDA ALÇAK BASINÇ PİRİNÇ KÜLÇEDEN ÜRETİLMİŞTİR.
- YÜZEY KAPLAMASI 0,16 MİKRON KROM KAPLAMADIR.
- SU AKIŞ BORUSU ÇAPI 18mm , SU AKIŞ BORUSU MS63 PİRİNÇTİR.
- ÇIKIŞ UCU UZUNLUĞU 180 mm'DİR.
- TESİSAT BAĞLANTILARI G ½' DİR.

### Wall Mounted Rotating Kitchen Faucet

- OUR PRODUCT IS MADE OF MS58/MS63 BRASS LOW PRESSURE INGOTS
- SURFACE COATING IS 0,16mm CHROME COATING
- THE DIAMETER FO THE PIPE IS 18, THE WATER FLOW PIPE MS63 IS BRASS
- OUTPUT LENGTH 180mm
- INSTALLATION CONNECTIONS ARE G ½

12 | 1.800,00 ₺  
Code: 44 2010 0907



**Kuşu Mutfak Bataryası**

- ÜRÜNÜMÜZ MS58 PİRİNÇ MALZEMEDEN ÜRETİLMİŞTİR.
- YÜZEY KAPLAMASI 0,12 İLE 0,16 MİKRON KROM KAPLAMADIR.
- ÇIKIŞ UCU UZUNLUĞU 165 mm'DİR.
- ÇIKIŞ UCU YÜKSEKLİĞİ 240 mm'DİR.
- SU AKIŞ BORUSU ÇAPI 18mm , SU AKIŞ BORUSU MS63 PİRİNÇTİR.
- 360 DERECE DÖNER BORULUDUR.
- 3/8 M-10 40 BAR BASINCA DAYANIKLI ÇELİK ÖRGÜLÜ FLEX KULLANILMIŞTIR.

**Kitchen Faucet**

- OUR PRODUCT IS MADE OF MS58 BRASS
- SURFACE COATING IS 0,16mm CHROME COATING
- OUTPUT LENGTH 165mm
- OUTPUT END PIPE HEIGHT IS 240mm
- THE DIAMETER FO THE PIPE IS 18, THE WATER FLOW PIPE MS63 IS BRASS
- 360 ROTARY PIPE
- G 3/8 M-10 40 BAR PRESSURE RESISTANT STEEL BRAIDED FLEX USED

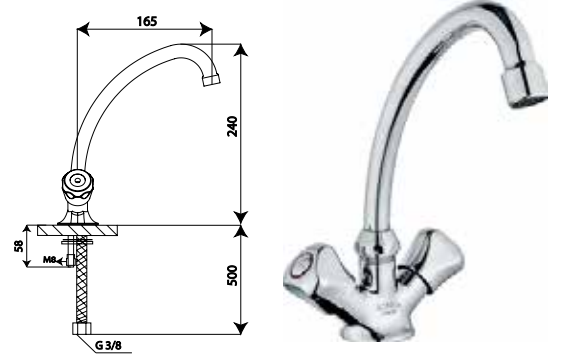

12 | 1.600,00 ₺  
Code: 44 2010 0906

**Duvardan Tek Çıkışlı Döner Mutfak Bataryası**

- ÜRÜNÜMÜZ MS58 PİRİNÇ MALZEMEDEN ÜRETİLMİŞTİR.
- YÜZEY KAPLAMASI 0,16 MİKRON KROM KAPLAMADIR.
- SU AKIŞ BORUSU ÇAPI 18mm , SU AKIŞ BORUSU MS63 PİRİNÇTİR.
- ÇIKIŞ UCU UZUNLUĞU 135 mm'DİR.
- TESİSAT BAĞLANTILARI G ½' DİR.

**One-Way Rotary Kitchen Faucet From The Wall**

- OUR PRODUCT IS MADE OF MS58 BRASS
- SURFACE COATING IS 0,16mm CHROME COATING
- THE DIAMETER FO THE PIPE IS 18, THE WATER FLOW PIPE MS63 IS BRASS
- OUTPUT LENGTH 135mm
- INSTALLATION CONNECTIONS ARE G ½

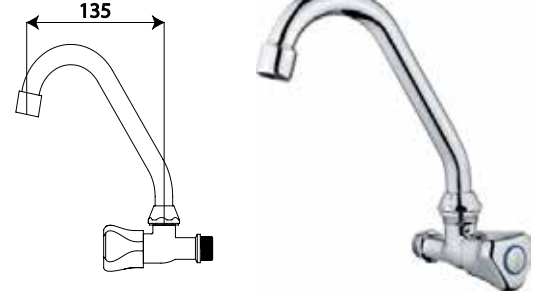

12 | 900,00 ₺  
Code: 44 2010 0910

**Mermer Üstü Tek Çıkışlı Döner Lavabo Bataryası**

- ÜRÜNÜMÜZ MS58 PİRİNÇ MALZEMEDEN ÜRETİLMİŞTİR.
- YÜZEY KAPLAMASI 0,16 MİKRON KROM KAPLAMADIR.
- SU AKIŞ BORUSU ÇAPI 18mm , SU AKIŞ BORUSU MS63 PİRİNÇTİR.
- ÇIKIŞ UCU UZUNLUĞU 135 mm'DİR.
- TESİSAT BAĞLANTILARI G ½' DİR.

**Marble Top One-Way Faucet**

- OUR PRODUCT IS MADE OF MS58 BRASS
- SURFACE COATING IS 0,16mm CHROME COATING
- THE DIAMETER FO THE PIPE IS 18, THE WATER FLOW PIPE MS63 IS BRASS
- OUTPUT LENGTH 135mm
- INSTALLATION CONNECTIONS ARE G ½

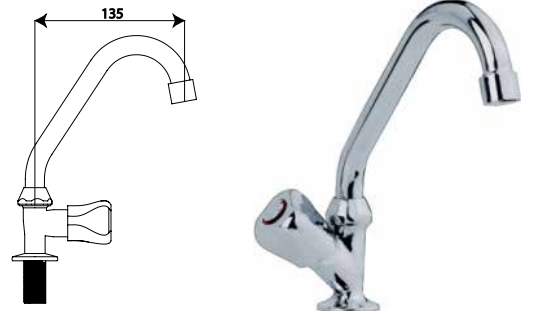

12 | 1.100,00 ₺  
Code: 44 2010 0909



## Uzun Musluk

- ÜRÜNÜMÜZ MS58 MALZEMEDEN ÜRETİLMİŞTİR.
- YÜZEY KAPLAMASI 0,12 İLE 0,16 MİKRON KROM KAPLAMADIR.
- MS58 KAPALI SİSTEM G1/2 SALMASTRA KULLANILMIŞTIR.
- ÇIKIŞ UCU UZUNLUĞU 125 mm'DİR.
- TESİSAT BAĞLANTILARI G 1/2' DİR.

### Long Tap

- OUR PRODUCT IS MADE OF MS58 BRASS
- SURFACE COATING IS 0,16mm CHROME COATING
- MS58 OFF SYSTEM G1/2 CARTRIDGE
- OUTPUT LENGTH 125mm
- INSTALLATION CONNECTIONS ARE G 1/2

50 | 390,00 ₺  
Code: 44 2010 0913



## Aç-Kapa Uzun Musluk

- ÜRÜNÜMÜZ MS58 MALZEMEDEN ÜRETİLMİŞTİR.
- YÜZEY KAPLAMASI 0,12 İLE 0,16 MİKRON KROM KAPLAMADIR.
- MS58 KAPALI SİSTEM G1/2 SALMASTRA KULLANILMIŞTIR.
- ÇIKIŞ UCU UZUNLUĞU 125 mm'DİR.
- TESİSAT BAĞLANTILARI G 1/2' DİR.

### Long Tap

- OUR PRODUCT IS MADE OF MS58 BRASS
- SURFACE COATING IS 0,16mm CHROME COATING
- MS58 OFF SYSTEM G1/2 CARTRIDGE
- OUTPUT LENGTH 125mm
- INSTALLATION CONNECTIONS ARE G 1/2

50 | 410,00 ₺  
Code: 44 2010 0941



## Kısa Musluk

- ÜRÜNÜMÜZ MS58 MALZEMEDEN ÜRETİLMİŞTİR.
- YÜZEY KAPLAMASI 0,12 İLE 0,16 MİKRON KROM KAPLAMADIR.
- MS58 KAPALI SİSTEM G1/2 SALMASTRA KULLANILMIŞTIR.
- ÇIKIŞ UCU UZUNLUĞU 90 mm'DİR.
- TESİSAT BAĞLANTILARI G 1/2' DİR.

### Short Tap

- OUR PRODUCT IS MADE OF MS58 BRASS
- SURFACE COATING IS 0,16mm CHROME COATING
- MS58 OFF SYSTEM G1/2 CARTRIDGE
- OUTPUT LENGTH 90mm
- INSTALLATION CONNECTIONS ARE G 1/2

50 | 390,00 ₺  
Code: 44 2010 0914

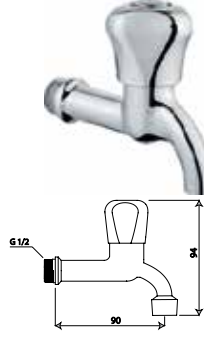

## Aç-Kapa Kısa Musluk

- ÜRÜNÜMÜZ MS58 MALZEMEDEN ÜRETİLMİŞTİR.
- YÜZEY KAPLAMASI 0,12 İLE 0,16 MİKRON KROM KAPLAMADIR.
- MS58 KAPALI SİSTEM G1/2 SALMASTRA KULLANILMIŞTIR.
- ÇIKIŞ UCU UZUNLUĞU 90 mm'DİR.
- TESİSAT BAĞLANTILARI G 1/2' DİR.

### Short Tap

- OUR PRODUCT IS MADE OF MS58 BRASS
- SURFACE COATING IS 0,16mm CHROME COATING
- MS58 OFF SYSTEM G1/2 CARTRIDGE
- OUTPUT LENGTH 90mm
- INSTALLATION CONNECTIONS ARE G 1/2

50 | 410,00 ₺  
Code: 44 2010 0942



## Çamaşır Musluk

- ÜRÜNÜMÜZ MS58 MALZEMEDEN ÜRETİLMİŞTİR.
- YÜZEY KAPLAMASI 0,12 İLE 0,16 MİKRON KROM KAPLAMADIR.
- MS58 KAPALI SİSTEM G1/2 SALMASTRA KULLANILMIŞTIR.
- ÇIKIŞ UCU UZUNLUĞU 56 mm'DİR.
- TESİSAT BAĞLANTILARI G 1/2' DİR.

### Laundry Tap

- OUR PRODUCT IS MADE OF MS58 BRASS
- SURFACE COATING IS 0,16mm CHROME COATING
- MS58 OFF SYSTEM G1/2 CARTRIDGE
- OUTPUT LENGTH 56mm
- INSTALLATION CONNECTIONS ARE G 1/2

50 | 390,00 ₺  
Code: 44 2010 0912

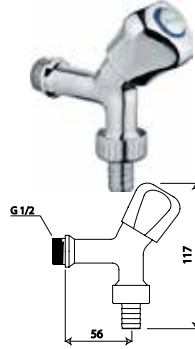

## Aç-Kapa Çamaşır Musluk

- ÜRÜNÜMÜZ MS58 MALZEMEDEN ÜRETİLMİŞTİR.
- YÜZEY KAPLAMASI 0,12 İLE 0,16 MİKRON KROM KAPLAMADIR.
- MS58 KAPALI SİSTEM G1/2 SALMASTRA KULLANILMIŞTIR.
- ÇIKIŞ UCU UZUNLUĞU 56 mm'DİR.
- TESİSAT BAĞLANTILARI G 1/2' DİR.

### Laundry Tap

- OUR PRODUCT IS MADE OF MS58 BRASS
- SURFACE COATING IS 0,16mm CHROME COATING
- MS58 OFF SYSTEM G1/2 CARTRIDGE
- OUTPUT LENGTH 56mm
- INSTALLATION CONNECTIONS ARE G 1/2

50 | 410,00 ₺  
Code: 44 2010 0953



## Mix Aç-Kapa Musluk

- ÜRÜNÜMÜZ MS58 MALZEMEDEN ÜRETİLMİŞTİR.
- YÜZEY KAPLAMASI 0,12 İLE 0,16 MİKRON KROM KAPLAMADIR.
- SERAMİK KARTUŞ KULLANILMAKTADIR.
- ÇIKIŞ UCU UZUNLUĞU 125 mm'DİR.
- TESİSAT BAĞLANTILARI G 1/2' DİR.

### Mix On-0 Tap

- OUR PRODUCT IS MADE OF MS58 BRASS
- SURFACE COATING IS 0,16mm CHROME COATING
- CERAMIC CARTRIDGE USED
- OUTPUT LENGTH 125mm
- INSTALLATION CONNECTIONS ARE G 1/2

30 | 465,00 ₺  
Code: 44 2010 0915

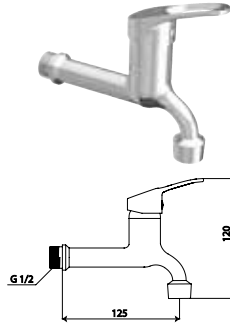

## G 1/2 Musluk Başı Takımı G 1/2 Faucet Knob Set



150 | 170,00 ₺  
Code: 44 2010 0932

## Çaydanlık Musluğu

- ÇIKIŞ UCU UZUNLUĞU 98 mm'DİR.
- TESİSAT BAĞLANTISI G 1/2'DİR.

### Tea Pot Tap

- OUTPUT LENGTH 98mm
- INSTALLATION CONNECTIONS ARE G 1/2

50 | 615,00 ₺  
Code: 44 2010 0974

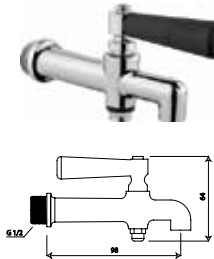

## Musluk Volanı Faucet Knob



150 | 75,00 ₺  
Code: 44 2010 0933



1/2 Salmastra  
1/2 Seal

200 | 110,00 ₺  
Code: 44 2010 0935



1/2 Aç-Kapa Salmastra  
1/2 On-Off Seal

200 | 125,00 ₺  
Code: 44 2010 0972

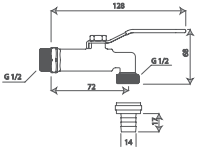

**1/2 Kollu Küresel Bahçe Musluğu**

100 | **360,00 ₺**  
Code: 44 2010 0966

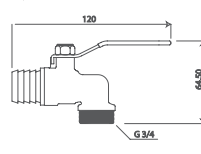

**Küresel Bas Draineage Ball Tap**

100 | **450,00 ₺**  
Code: 44 2010 0965

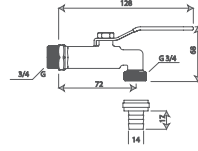

**3/4 Kollu Küresel Bahçe Musluğu**

100 | **450,00 ₺**  
Code: 44 2010 0971

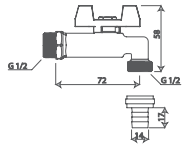

**1/2 Kelebek Küresel Bahçe Musluğu**

100 | **360,00 ₺**  
Code: 44 2010 0967

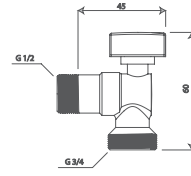

**Mini Küresel Çamaşır Musluğu Drainage Laundry Tap**

100 | **200,00 ₺**  
Code: 44 2010 0973

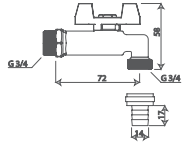

**3/4 Kelebek Küresel Bahçe Musluğu**

100 | **450,00 ₺**  
Code: 44 2010 0968

## LAVABO SIFONU VE ZAMAN AYARLI MUSLUKLAR

**Pisuar Taharet Musluğu Urinal Tap**



30 | **600,00 ₺**  
Code: 44 2010 0970

**Zaman Ayarlı Basmalı Pisuar Musluğu Time Adustment Push System Urinal Flush**

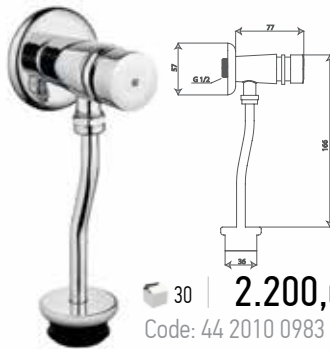

30 | **2.200,00 ₺**  
Code: 44 2010 0983

**Basmalı Pisuar Musluğu Push System Urinal Flush**



30 | **1.800,00 ₺**  
Code: 44 2010 0958

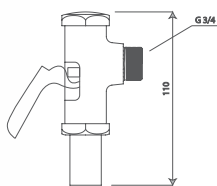

**Otomatik Yaylı Bas Automatic Springy Flush**

30 | **1.950,00 ₺**  
Code: 44 2010 0959



 aceser® bir damla sanat



## Roka Aç-Kapa Plastik Başlıklı Taharet Musluk

- ÜRÜNÜMÜZ MS58 MALZEMEDEN ÜRETİLMİŞTİR.
- YÜZEY KAPLAMASI 0,12 İLE 0,16 MİKRON KROM KAPLAMADIR.
- AÇ-KAPA 3/8 SALMASTRA KULLANILMIŞTIR.
- ABS BAŞLIK
- ÜRÜN UZUNLUĞU 66 mm'DİR.
- TESİSAT BAĞLANTISI 1/2" DİR
- ÇIKIŞ UCU G3/8

### On-Off Bidet Tap

- OUR PRODUCT IS MADE OF MS58 BRASS
- SURFACE COATING IS 0,16mm CHROME COATING
- ON-OFF 3/8 CARTRIDGE USED
- ABS HEADGEAR
- PRODUCT LENGTH 66mm
- INSTALLATION CONNECTIONS ARE G 1/2
- OUTPUT G3/8

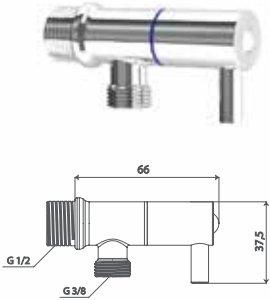

150 | 290,00 ₺  
Code: 44 2010 0997

## Roka Aç-Kapa Taharet Musluk

- ÜRÜNÜMÜZ MS58 MALZEMEDEN ÜRETİLMİŞTİR.
- YÜZEY KAPLAMASI 0,12 İLE 0,16 MİKRON KROM KAPLAMADIR.
- AÇ-KAPA 3/8 SALMASTRA KULLANILMIŞTIR.
- ABS BAŞLIK
- ÜRÜN UZUNLUĞU 75 mm'DİR.
- TESİSAT BAĞLANTISI 1/2" DİR
- ÇIKIŞ UCU G3/8

### On-Off Bidet Tap

- OUR PRODUCT IS MADE OF MS58 BRASS
- SURFACE COATING IS 0,16mm CHROME COATING
- ON-OFF 3/8 CARTRIDGE USED
- ABS HEADGEAR
- PRODUCT LENGTH 75mm
- INSTALLATION CONNECTIONS ARE G 1/2
- OUTPUT G3/8

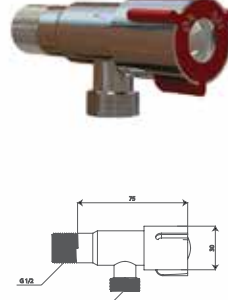

150 | 360,00 ₺  
Code: 44 2010 0995

## Aç-Kapa Plastik Kromlu Tah. Musluk

- ÜRÜNÜMÜZ MS58 MALZEMEDEN ÜRETİLMİŞTİR.
- YÜZEY KAPLAMASI 0,12 İLE 0,16 MİKRON KROM KAPLAMADIR.
- AÇ-KAPA 3/8 SALMASTRA KULLANILMIŞTIR.
- ABS BAŞLIK
- ÜRÜN UZUNLUĞU 59 mm'DİR.
- TESİSAT BAĞLANTISI G 1/2" DİR.
- ÇIKIŞ UCU G 3/8

### On-Off Brass Bidet Tap

- OUR PRODUCT IS MADE OF MS58 BRASS
- SURFACE COATING IS 0,16mm CHROME COATING
- ON-OFF 3/8 CARTRIDGE USED
- ABS HEADGEAR
- PRODUCT LENGTH 59mm
- INSTALLATION CONNECTIONS ARE G 1/2
- OUTPUT G 3/8

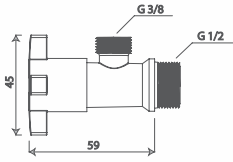

150 | 250,00 ₺  
Code: 44 2010 0945

## Aç-Kapa Kare Piriç Taharet Musluk

- ÜRÜNÜMÜZ MS58 MALZEMEDEN ÜRETİLMİŞTİR.
- YÜZEY KAPLAMASI 0,12 İLE 0,16 MİKRON KROM KAPLAMADIR.
- AÇ-KAPA 3/8 SALMASTRA KULLANILMIŞTIR.
- PRİNÇ KARE BAŞLIK KULLANILMIŞTIR.
- ÜRÜN UZUNLUĞU 50 mm'DİR.
- TESİSAT BAĞLANTISI G 1/2" DİR.
- ÇIKIŞ UCU G 3/8

### On-O Brass Square Bidet Tap

- OUR PRODUCT IS MADE OF MS58 BRASS
- SURFACE COATING IS 0,16mm CHROME COATING
- ON-OFF 3/8 CARTRIDGE USED
- BRASS HEADGEAR HAS BEEN USED
- PRODUCT LENGTH 50mm
- INSTALLATION CONNECTIONS ARE G 1/2
- OUTPUT G3/8

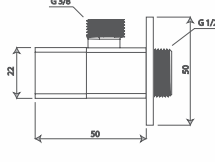

150 | 490,00 ₺  
Code: 44 2010 0947

## Aç-Kapa Prinç Yıldız Tah. Musluk

- ÜRÜNÜMÜZ MS58 MALZEMEDEN ÜRETİLMİŞTİR.
- YÜZEY KAPLAMASI 0,12 İLE 0,16 MİKRON KROM KAPLAMADIR.
- YILDIZ PRİNÇ BAŞLIK KULLANILMIŞTIR.
- AÇ-KAPA 3/8 SALMASTRA KULLANILMIŞTIR.
- ÜRÜN UZUNLUĞU 70 mm'DİR.
- TESİSAT BAĞLANTISI G 1/2" DİR.
- ÇIKIŞ UCU G 3/8

### On-O Brass Star Bidet Tap

- OUR PRODUCT IS MADE OF MS58 BRASS
- SURFACE COATING IS 0,16mm CHROME COATING
- STAR BRASS HEADGEAR HAS BEEN USED
- ON-OFF 3/8 CARTRIDGE USED
- PRODUCT LENGTH 70mm
- INSTALLATION CONNECTIONS ARE G 1/2
- OUTPUT G 3/8

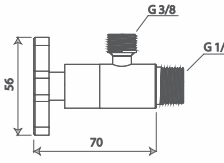

75 | 460,00 ₺  
Code: 44 2010 0944

## Aç-Kapa Yıldız Tah. Musluk

- ÜRÜNÜMÜZ MS58 MALZEMEDEN ÜRETİLMİŞTİR.
- YÜZEY KAPLAMASI 0,12 İLE 0,16 MİKRON KROM KAPLAMADIR.
- AÇ-KAPA 3/8 SALMASTRA KULLANILMIŞTIR.
- PRİNÇ KARE BAŞLIK KULLANILMIŞTIR.
- ÜRÜN UZUNLUĞU 50 mm'DİR.
- TESİSAT BAĞLANTISI G 1/2" DİR.
- ÇIKIŞ UCU G 3/8

### On-O Star Bidet Tap

- OUR PRODUCT IS MADE OF MS58 BRASS
- SURFACE COATING IS 0,16mm CHROME COATING
- ON-OFF 3/8 CARTRIDGE USED
- BRASS HEADGEAR HAS BEEN USED
- PRODUCT LENGTH 50mm
- INSTALLATION CONNECTIONS ARE G 1/2
- OUTPUT G3/8

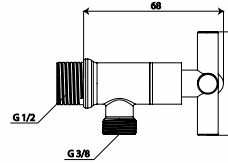

150 | 260,00 ₺  
Code: 44 2010 0996

## Roka Piriç Kromlu Taharet Musluk

- ÜRÜNÜMÜZ MS58 MALZEMEDEN ÜRETİLMİŞTİR.
- YÜZEY KAPLAMASI 0,12 İLE 0,16 MİKRON KROM KAPLAMADIR.
- PRİNÇ BAŞLIK KULLANILMIŞTIR.
- AÇ-KAPA 3/8 SALMASTRA KULLANILMIŞTIR.
- ÜRÜN UZUNLUĞU 54 mm'DİR.
- TESİSAT BAĞLANTISI G 1/2" DİR.
- ÇIKIŞ UCU G 3/8

### On-Off Brass Bidet Tap

- OUR PRODUCT IS MADE OF MS58 BRASS
- SURFACE COATING IS 0,16mm CHROME COATING
- BRASS HEADGEAR HAS BEEN USED
- ON-OFF 3/8 CARTRIDGE USED
- PRODUCT LENGTH 54 mm
- INSTALLATION CONNECTIONS ARE G 1/2
- OUTPUT G 3/8

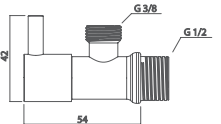

150 | 360,00 ₺  
Code: 44 2010 0949



#### Filtreli Kromlu Tah. Mus. (Ağır Tip)

- ÜRÜN UZUNLUĞU 55 mm'DİR.
- TESİSAT BAĞLANTISI G 1/2' DİR.
- ÇIKIŞ UCU G 3/8

VAKUMLU

#### On-Off Bidet Tap

- PRODUCT LENGTH 59mm
- INSTALLATION CONNECTIONS ARE G 1/2
- OUTPUT G 3/8

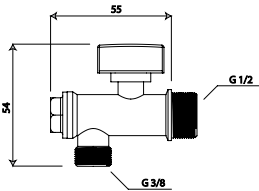

150 | 185,00 ₺

Code: 44 2010 0984



#### Filtreli Kromlu Taharet Musluğu (Eko Tip)

- ÜRÜN UZUNLUĞU 55 mm'DİR.
- TESİSAT BAĞLANTISI G 1/2' DİR.
- ÇIKIŞ UCU G 3/8

POŞETLİ

#### Filtered Bidet Tap

- PRODUCT LENGTH 59mm
- INSTALLATION CONNECTIONS ARE G 1/2
- OUTPUT G 3/8

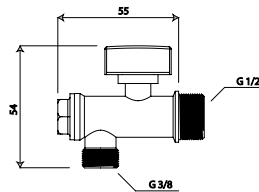

150 | 149,00 ₺

Code: 44 2010 0920





## Kelebek Kromlu Taharet Musluk

- ÜRÜNÜMÜZ MS58 MALZEMEDEN ÜRETİLMİŞTİR.
- YÜZEY KAPLAMASI 0,12 İLE 0,16 MİKRON KROM KAPLAMADIR.
- 3/8 SALMASTRA KULLANILMIŞTIR.
- ABS BAŞLIK
- ÜRÜN UZUNLUĞU 58 mm'DİR.
- TESİSAT BAĞLANTISI G 1/2' DİR.
- ÇIKIŞ UCU G 3/8

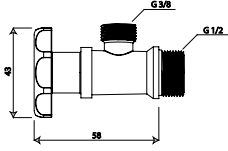

## Bidet Tap

- OUR PRODUCT IS MADE OF MS58 BRASS
- SURFACE COATING IS 0,16mm CHROME COATING
- 3/8 CARTRIDGE USED
- ABS HEADGEAR
- PRODUCT LENGTH 58mm
- INSTALLATION CONNECTIONS ARE G 1/2
- OUTPUT G3/8

150 | 230,00 ₺  
Code: 44 2010 0924



## Prinç Başlıklı Taharet Musluk

- ÜRÜNÜMÜZ MS58 MALZEMEDEN ÜRETİLMİŞTİR.
- YÜZEY KAPLAMASI 0,12 İLE 0,16 MİKRON KROM KAPLAMADIR.
- PRİNÇ BAŞLIK KULLANILMIŞTIR.
- 3/8 SALMASTRA KULLANILMIŞTIR.
- ÜRÜN UZUNLUĞU 63 mm'DİR.
- TESİSAT BAĞLANTISI G 1/2' DİR.
- ÇIKIŞ UCU G 3/8

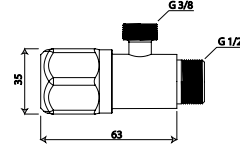

## Brass Bidet Tap

- OUR PRODUCT IS MADE OF MS58 BRASS
- SURFACE COATING IS 0,16mm CHROME COATING
- BRASS HEADGEAR HAS BEEN USED
- 3/8 CARTRIDGE USED
- PRODUCT LENGTH 63 mm
- INSTALLATION CONNECTIONS ARE G 1/2
- OUTPUT G 3/8

150 | 340,00 ₺  
Code: 44 2010 0922



## Tiger Taharet Musluk

- ÜRÜNÜMÜZ MS58 MALZEMEDEN ÜRETİLMİŞTİR.
- YÜZEY KAPLAMASI 0,12 İLE 0,16 MİKRON KROM KAPLAMADIR.
- A3/8 SALMASTRA KULLANILMIŞTIR.
- ÜRÜN UZUNLUĞU 58 mm'DİR.
- TESİSAT BAĞLANTISI G 1/2' DİR.
- ÇIKIŞ UCU G 3/8

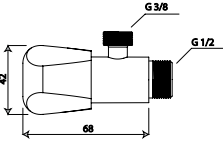

## Tiger Bidet Tap

- OUR PRODUCT IS MADE OF MS58 BRASS
- SURFACE COATING IS 0,16mm CHROME COATING
- 3/8 CARTRIDGE USED
- PRODUCT LENGTH 58mm
- INSTALLATION CONNECTIONS ARE G 1/2
- OUTPUT G3/8

150 | 250,00 ₺  
Code: 44 2010 0921



## Taharet Musluk

- ÜRÜNÜMÜZ MS58 MALZEMEDEN ÜRETİLMİŞTİR.
- YÜZEY KAPLAMASI 0,12 İLE 0,16 MİKRON KROM KAPLAMADIR.
- 3/8 SALMASTRA KULLANILMIŞTIR.
- ÜRÜN UZUNLUĞU 68 mm'DİR.
- TESİSAT BAĞLANTISI G 1/2' DİR.
- ÇIKIŞ UCU G 3/8

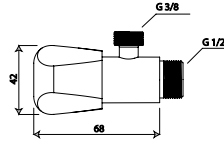

## Bidet Tap

- OUR PRODUCT IS MADE OF MS58 BRASS
- SURFACE COATING IS 0,16mm CHROME COATING
- 3/8 CARTRIDGE USED
- PRODUCT LENGTH 68mm
- INSTALLATION CONNECTIONS ARE G 1/2
- OUTPUT G3/8

150 | 270,00 ₺  
Code: 44 2010 0946



## Kumlamalı Taharet Musluk (Poşetli)

- ÜRÜNÜMÜZ MS58 MALZEMEDEN ÜRETİLMİŞTİR.
- KÜMLAMALI GÖVDE
- 3/8 SALMASTRA KULLANILMIŞTIR.
- ABS BAŞLIK
- ÜRÜN UZUNLUĞU 56 mm'DİR.
- TESİSAT BAĞLANTISI G 1/2' DİR.
- ÇIKIŞ UCU G 3/8

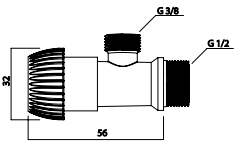

## Sandblasted Bidet Tap

- OUR PRODUCT IS MADE OF MS58 BRASS
- SANDBLASTED BODY
- 3/8 CARTRIDGE USED
- ABS HEADGEAR
- PRODUCT LENGTH 56mm
- INSTALLATION CONNECTIONS ARE G 1/2
- OUTPUT G3/8

150 | 189,00 ₺  
Code: 44 2010 0956



## Filtreli Tah. Musluğu VAKUMLU

- ÜRÜNÜMÜZ MS58 MALZEMEDEN ÜRETİLMİŞTİR.
- YÜZEY KAPLAMASI 0,12 İLE 0,16 MİKRON KROM KAPLAMADIR.
- AÇ-KAPA 3/8 SALMASTRA KULLANILMIŞTIR.
- ÖZEL FİLTRE
- ABS BAŞLIK
- ÜRÜN UZUNLUĞU 55 mm'DİR.
- TESİSAT BAĞLANTISI G 1/2' DİR.
- ÇIKIŞ UCU G 3/8

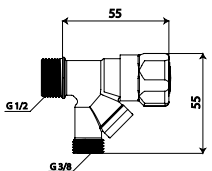

## Filtered Bedet Tap

- OUR PRODUCT IS MADE OF MS58 BRASS
- SURFACE COATING IS 0,16mm CHROME COATING
- ON-OFF 3/8 CARTRIDGE USED
- CUSTOM FILTER
- ABS HEADGEAR
- PRODUCT LENGTH 55 mm
- INSTALLATION CONNECTIONS ARE G 1/2
- OUTPUT G3/8

150 | 320,00 ₺  
Code: 44 2010 0919



## Filtreli Tah. Musluğu VAKUMSUZ

- ÜRÜNÜMÜZ MS58 MALZEMEDEN ÜRETİLMİŞTİR.
- YÜZEY KAPLAMASI 0,12 İLE 0,16 MİKRON KROM KAPLAMADIR.
- AÇ-KAPA 3/8 SALMASTRA KULLANILMIŞTIR.
- ÖZEL FİLTRE
- ABS BAŞLIK
- ÜRÜN UZUNLUĞU 55 mm'DİR.
- TESİSAT BAĞLANTISI G 1/2' DİR.
- ÇIKIŞ UCU G 3/8

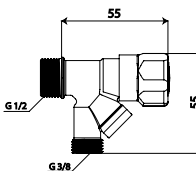

## Filtered Bedet Tap

- OUR PRODUCT IS MADE OF MS58 BRASS
- SURFACE COATING IS 0,16mm CHROME COATING
- ON-OFF 3/8 CARTRIDGE USED
- CUSTOM FILTER
- ABS HEADGEAR
- PRODUCT LENGTH 55 mm
- INSTALLATION CONNECTIONS ARE G 1/2
- OUTPUT G3/8

150 | 280,00 ₺  
Code: 44 2010 0978

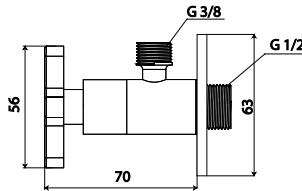

#### Duck Kırmızı Renkli

#### Aç-Kapa Prinç Yıldız Tah. Musluk

- ÜRÜNÜMÜZ MS58 MALZEMEDEN ÜRETİLMİŞTİR.
- YÜZEY KAPLAMASI PULVER 916 BOYADIR.
- YILDIZ PRİNÇ BAŞLIK KULLANILMIŞTIR.
- AÇ-KAPA 3/8 SALMASTRA KULLANILMIŞTIR.
- ÜRÜN UZUNLUĞU 70 mm'DİR.
- TESİSAT BAĞLANTISI G 1/2' DİR.
- ÇIKIŞ UCU G 3/8
- ROZET DAHİLDİR.

#### Duck Red Colored

#### On-O Brass Star Bidet Tap

- OUR PRODUCT IS MADE OF MS58 BRASS
- SURFACE COATING IS PAINTED 916.
- STAR BRASS HEADGEAR HAS BEEN USED
- ON-OFF 3/8 CARTRIDGE USED
- PRODUCT LENGTH 70mm
- INSTALLATION CONNECTIONS ARE G 1/2
- OUTPUT G 3/8
- MIRROR INCLUDED

75 | 595,00 ₺

Code: 10 2010 0003

**Duck İnci Siyah Renkli****Aç-Kapa Prinç Yıldız Tah. Musluk**

- ÜRÜNÜMÜZ MS58 MALZEMEDEN ÜRETİLMİŞTİR.
- YÜZEY KAPLAMASI ÖZEL İNCİ SİYAH BOYADIR.
- YILDIZ PRİNÇ BAŞLIK KULLANILMIŞTIR.
- AÇ-KAPA 3/8 SALMASTRA KULLANILMIŞTIR.
- ÜRÜN UZUNLUĞU 70 mm'DİR.
- TESİSAT BAĞLANTISI G 1/2' DİR.
- ÇIKIŞ UCU G 3/8
- ROZET DAHİLDİR.

**Duck Pearl Black Colored****On-O Brass Star Bidet Tap**

- OUR PRODUCT IS MADE OF MS58 BRASS
- SURFACE COATING IS A SPECIAL PEARL BLACK PAINT.
- STAR BRASS HEADGEAR HAS BEEN USED
- ON-OFF 3/8 CARTRIDGE USED
- PRODUCT LENGTH 70mm
- INSTALLATION CONNECTIONS ARE G 1/2
- OUTPUT G 3/8
- MIRROR INCLUDED

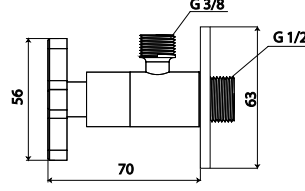

75 | 680,00 ₺  
Code: 10 2010 0001

**Duck Altın Renkli****Aç-Kapa Prinç Yıldız Tah. Musluk**

- ÜRÜNÜMÜZ MS58 MALZEMEDEN ÜRETİLMİŞTİR.
- YÜZEY KAPLAMASI ÖZEL ALTIN BOYADIR.
- YILDIZ PRİNÇ BAŞLIK KULLANILMIŞTIR.
- AÇ-KAPA 3/8 SALMASTRA KULLANILMIŞTIR.
- ÜRÜN UZUNLUĞU 70 mm'DİR.
- TESİSAT BAĞLANTISI G 1/2' DİR.
- ÇIKIŞ UCU G 3/8
- ROZET DAHİLDİR.

**Duck Gold Colored****On-O Brass Star Bidet Tap**

- OUR PRODUCT IS MADE OF MS58 BRASS
- SURFACE COATING IS SPECIAL GOLD PAINT.
- STAR BRASS HEADGEAR HAS BEEN USED
- ON-OFF 3/8 CARTRIDGE USED
- PRODUCT LENGTH 70mm
- INSTALLATION CONNECTIONS ARE G 1/2
- OUTPUT G 3/8
- MIRROR INCLUDED

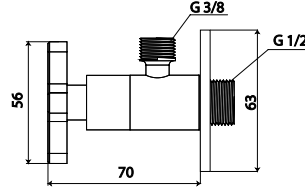

75 | 680,00 ₺  
Code: 10 2010 0002

**Duck Beyaz Renkli****Aç-Kapa Prinç Yıldız Tah. Musluk**

- ÜRÜNÜMÜZ MS58 MALZEMEDEN ÜRETİLMİŞTİR.
- YÜZEY KAPLAMASI PULVER 916 BOYADIR.
- YILDIZ PRİNÇ BAŞLIK KULLANILMIŞTIR.
- AÇ-KAPA 3/8 SALMASTRA KULLANILMIŞTIR.
- ÜRÜN UZUNLUĞU 70 mm'DİR.
- TESİSAT BAĞLANTISI G 1/2' DİR.
- ÇIKIŞ UCU G 3/8
- ROZET DAHİLDİR.

**Duck White Colored****On-O Brass Star Bidet Tap**

- OUR PRODUCT IS MADE OF MS58 BRASS
- SURFACE COATING IS PAINTED 916.
- STAR BRASS HEADGEAR HAS BEEN USED
- ON-OFF 3/8 CARTRIDGE USED
- PRODUCT LENGTH 70mm
- INSTALLATION CONNECTIONS ARE G 1/2
- OUTPUT G 3/8
- MIRROR INCLUDED

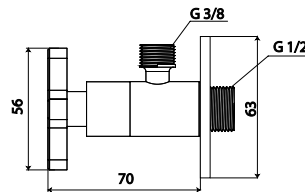

75 | 595,00 ₺  
Code: 10 2010 0004



## Sarı Nipel

Kod	Ölçü	Ürün	Koli	Fiyat
52 2010 6302	3/8"	Sarı Nipel	100	<b>42,00</b>
52 2010 6303	1/2"	Sarı Nipel	100	<b>54,00</b>
52 2010 6304	3/4"	Sarı Nipel	50	<b>78,00</b>
52 2010 6305	1"	Sarı Nipel	25	<b>132,00</b>
52 2010 6306	1" 1/4"	Sarı Nipel	25	<b>310,00</b>
52 2010 6307	1" 1/2"	Sarı Nipel	10	<b>390,00</b>
52 2010 6308	2"	Sarı Nipel	10	<b>564,00</b>



## Saat Rakoru

Kod	Ölçü	Ürün	Koli	Fiyat
54 2010 5275	1/2"	Saat Rak. (Çiftli)	200	-
54 2010 5276	3/4"	Saat Rak. (Çiftli)	200	<b>280,00</b>
54 2010 5277	1"	Saat Rak. (Çiftli)	-	<b>300,00</b>
54 2010 6357	1" 1/4"	Saat Rak. (Çiftli)	-	-
54 2010 6358	1" 1/2"	Saat Rak. (Çiftli)	-	-
54 2010 6359	2"	Saat Rak. (Çiftli)	-	-

## Orantılı Nipel

Kod	Ölçü	Ürün	Koli	Fiyat
52 2010 6310	3/8"-1/2"	Orantılı Nipel	-	<b>63,00</b>
52 2010 6311	1/2"-3/4"	Orantılı Nipel	100	<b>69,00</b>
52 2010 6312	3/4"-1"	Orantılı Nipel	100	<b>119,00</b>
52 2010 6313	1/2"-1"	Orantılı Nipel	75	<b>112,00</b>
52 2010 6315	1 1/4"-1"	Orantılı Nipel	50	<b>310,00</b>



## Sarı Redüksiyon

Kod	Ölçü	Ürün	Koli	Fiyat
52 2010 6328	3/8"-1/4"	Sarı Redüksiyon	100	<b>45,00</b>
52 2010 6329	3/8"-1/2"	Sarı Redüksiyon	50	<b>48,00</b>
52 2010 6330	1/2"-3/4"	Sarı Redüksiyon	25	<b>54,00</b>
52 2010 6332	1/2"-1"	Sarı Redüksiyon	100	<b>112,00</b>
52 2010 6333	1 1/4"-1/2"	Sarı Redüksiyon	100	<b>306,00</b>
52 2010 6334	1 1/4"-1"	Sarı Redüksiyon	-	<b>306,00</b>
52 2010 6335	1 1/2"-1 1/4"	Sarı Redüksiyon	-	<b>350,00</b>
52 2010 6336	2"-1 1/4"	Sarı Redüksiyon	-	<b>690,00</b>
52 2010 6337	2"-1 1/2"	Sarı Redüksiyon	-	<b>690,00</b>

## Batarya Uzatmaları

Kod	Ölçü	Ürün	Koli	Fiyat
54 2010 5292	3/4"	Bat. Uzatması Delikli	25	<b>240,00</b>
54 2010 5293	3/4"	Bat. Uzatması Deliksiz	25	<b>181,00</b>
54 2010 5294	1/2"	Batarya Uzatması	25	<b>304,00</b>



## Bas Uzatması

Kod	Ölçü	Ürün	Koli	Fiyat
54 2010 6360	3/4"	Bas Uzatması	50	<b>120,00</b>



## Lüx Uzatmalar Ø26

Kod	Ölçü	Ürün	Koli	Fiyat
44 2010 0925	1 cm	Lüx Uzatma	100	<b>56,00</b>
44 2010 0926	1,5 cm	Lüx Uzatma	100	<b>66,00</b>
44 2010 0927	2 cm	Lüx Uzatma	100	<b>79,00</b>
44 2010 0928	2,5 cm	Lüx Uzatma	50	<b>89,00</b>
44 2010 0929	3 cm	Lüx Uzatma	50	<b>107,00</b>
44 2010 0930	4 cm	Lüx Uzatma	50	<b>129,00</b>
44 2010 0931	5 cm	Lüx Uzatma	50	<b>155,00</b>











## 3/4 Uzatmalar Ø30

Kod	Ölçü	Ürün	Koli	Fiyat
54 2010 5286	1 cm	3/4" Uzatma	100	<b>78,00</b>
54 2010 5287	1,5 cm	3/4" Uzatma	100	<b>89,00</b>
54 2010 5288	2 cm	3/4" Uzatma	100	<b>98,00</b>
54 2010 5289	2,5 cm	3/4" Uzatma	50	<b>130,00</b>
54 2010 5290	3 cm	3/4" Uzatma	50	<b>150,00</b>
54 2010 1007	4 cm	3/4" Uzatma	50	<b>175,00</b>
54 2010 1008	5 cm	3/4" Uzatma	50	<b>270,00</b>



# ANKASTRE TAHARET VALFLERİ

Ankastre Ara Kesme Valfi Built-in Valve			Ankastre Kelebek Ara Kesme Valfi Built in Valve			Ankastre Roka Ara Kesme Valfi Built-in Valve		
Plastik İnsört 1/2 Plastik Salmastra	Plastik İnsört 1/2 Metal Salmastra	Metal İnsört 1/2 Metal Salmastra	Plastik İnsört 1/2 Plastik Salmastra	Plastik İnsört 1/2 Metal Salmastra	Metal İnsört 1/2 Metal Salmastra	Plastik İnsört 1/2 Plastik Salmastra	Plastik İnsört 1/2 Metal Salmastra	Metal İnsört 1/2 Metal Salmastra
530,00₺	590,00₺	650,00₺	550,00₺	600,00₺	670,00₺	550,00₺	600,00₺	670,00₺
Code: 15 2010 0013	Code: 15 2010 0014	Code: 15 2010 0015	Code: 15 2010 0019	Code: 15 2010 0020	Code: 15 2010 0021	Code: 15 2010 0025	Code: 15 2010 0026	Code: 15 2010 0027
								
Plastik İnsört 3/4 Plastik Salmastra	Plastik İnsört 3/4 Metal Salmastra	Metal İnsört 3/4 Metal Salmastra	Plastik İnsört 3/4 Plastik Salmastra	Metal İnsört 3/4 Metal Salmastra	Metal İnsört 3/4 Metal Salmastra	Plastik İnsört 3/4 Plastik Salmastra	Plastik İnsört 3/4 Metal Salmastra	Metal İnsört 3/4 Metal Salmastra
550,00₺	600,00₺	670,00₺	550,00₺	600,00₺	670,00₺	570,00₺	630,00₺	700,00₺
Code: 15 2010 0016	Code: 15 2010 0017	Code: 15 2010 0018	Code: 15 2010 0022	Code: 15 2010 0023	Code: 15 2010 0024	Code: 15 2010 0028	Code: 15 2010 0029	Code: 15 2010 0030
								
Otomatik Bas-Bırak Vana Auto. Push & Release Valve			Lüks Kare Model Ara Kesme Valfi Lux Square Model Built-in Valve			Yıldız Ankastre Ara Kesme Valfi Built-in Valve		
Plastik İnsört 3/4 Plastik Salmastra	Plastik İnsört 1/2 Plastik Salmastra	Plastik İnsört 1/2 Metal Salmastra	Metal İnsört 1/2 Metal Salmastra	Plastik İnsört 1/2 Plastik Salmastra	Plastik İnsört 1/2 Metal Salmastra	Metal İnsört 1/2 Metal Salmastra	Plastik İnsört 1/2 Metal Salmastra	Metal İnsört 1/2 Metal Salmastra
125,00₺	550,00₺	620,00₺	680,00₺	470,00₺	530,00₺	580,00₺		
Code: 15 2010 0031	Code: 15 2010 0032	Code: 15 2010 0033	Code: 15 2010 0034	Code: 15 2010 0038	Code: 15 2010 0039	Code: 15 2010 0040		
								
Plastik İnsört 3/4 Plastik Salmastra	Plastik İnsört 3/4 Metal Salmastra	Metal İnsört 3/4 Metal Salmastra	Plastik İnsört 3/4 Plastik Salmastra	Plastik İnsört 3/4 Metal Salmastra	Metal İnsört 3/4 Metal Salmastra	Plastik İnsört 3/4 Plastik Salmastra	Plastik İnsört 3/4 Metal Salmastra	Metal İnsört 3/4 Metal Salmastra
570,00₺	630,00₺	700,00₺	490,00₺	540,00₺	600,00₺			
Code: 15 2010 0035	Code: 15 2010 0036	Code: 15 2010 0037	Code: 15 2010 0041	Code: 15 2010 0042	Code: 15 2010 0043			





**Ankastre Banyo Batarya Seti**

- SIVA ALTI GÖVDE MS58/MS63 ORANINDA ALÇAK BASINÇ PİRİNÇ KÜLÇEDEN ÜRETİLMİŞTİR.
- PLASTİK MUHAFAZALIDIR
- 2 YOLLU YÖNLENDİRİCİ TAKIM
- YÖNLENDİRİCİ TAKIMI MS58 PİRİNÇ MALZEMEDİR
- 40 BAR BASINCA DAYANIKLI SERAMİK KARTUŞ KULLANILMAKTADIR
- TESİSAT BAĞLANTILARI G ½" DİR
- EL DUŞU BAĞLANTILARI G ½" DİR
- AYNA MS58 PİRİNÇ MALZEMEDEN ÜRETİLMİŞTİR.
- AYNA YÜZEYİ 0,12 İLE 0,16 ARASINDA KROM KAPLAMADIR.
- 200mm TEPE DUŞU..
- EL DUŞU
- 150cm PASLANMAZ KROM KAPLI DUŞ HORTUMU

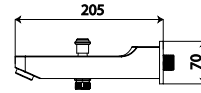
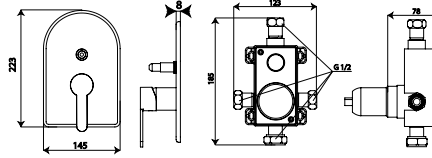
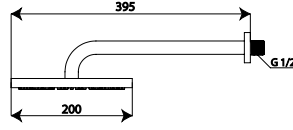
**Built-in Bathroom Faucet Surface Set**

- OUR PRODUCT IS MADE OF MS58/MS63 BRASS LOW PRESSURE INGOTS
- PLASTIC CASE
- 2-WAY ROUTER TOOL
- THE ROYTER TOOLS WAS MADE BRASS'S
- 40 BAR PRESSURE RESISTANT CERAMIC CARTRIDGE USED
- INSTALLATION CONNECTIONS ARE G ½
- HAND SHOWER CONNECTIONS ARE G ½
- MIRROR MS58 MADE OF BRASS MAREIAL
- MIRROR SURFACE COATING IS 0,16mm CHROME COATING
- 200mm SHOWER HEAD
- HAND SHOWER
- 150cm SS CHROME PLATED SHOWER PIPE
- BRAIDED FLEX USED

4 | 8.200,00 ₺

Code: 55 2010 5620

**Ankastre Duş Batarya Seti**

- SIVA ALTI GÖVDE MS58 PİRİNÇ MALZEMEDEN ÜRETİLMİŞTİR.
- 40 BAR BASINCA DAYANIKLI SERAMİK KARTUŞ KULLANILMAKTADIR
- TESİSAT BAĞLANTILARI G ½" DİR
- ABS AYNA
- 200mm TEPE DUŞU.

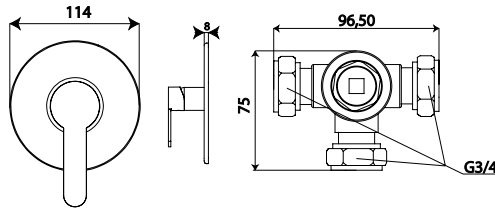
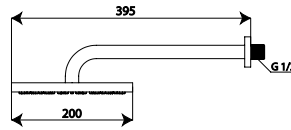
**Built-in Shower Mixer**

- OUR PRODUCT IS MADE OF MS58 BRASS
- 40 BAR PRESSURE RESISTANT CERAMIC CARTRIDGE USED
- INSTALLATION CONNECTIONS ARE G ½
- ABS MIRROR
- 200mm SHOWER HEAD

4 | 5.200,00 ₺

Code: 55 2010 5621



ROKA ANKASTRE SERİSİ



CHROME / KROM

1 | 9.400,00 ₺  
Code: 26 2010 0001



GOLD / ALTIN

1 | 10.400,00 ₺  
Code: 26 2010 0002



BLACK / SİYAH

1 | 9.800,00 ₺  
Code: 26 2010 0003

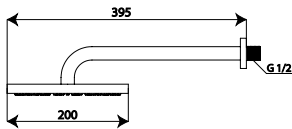

**Ankastre Banyo Batarya Seti**

- SIVA ALTI GÖVDE MS58/MS63 ORANINDA ALÇAK BASINÇ PİRİNÇ KÜLÇEDEN ÜRETİLMİŞTİR.
- PLASTİK MUHAFAZALIDIR
- 2 YOLLU YÖNLENDİRİCİ TAKIM
- YÖNLENDİRİCİ TAKIMI MS58 PİRİNÇ MALZEMEDİR
- 40 BAR BASINCA DAYANIKLI SERAMİK KARTUŞ KULLANILMAKTADIR
- TESİSAT BAĞLANTILARI G ½" DİR
- EL DUŞU BAĞLANTILARI G ½" DİR
- ABS AYNA
- 200X200mm KARE TEPE DUŞU.
- EL DUŞU
- 150cm PASLANMAZ KROM KAPLI DUŞ HORTUMU

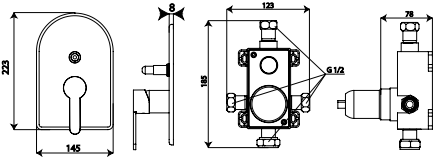

**Built-in Bathroom Faucet Surface Set**

- OUR PRODUCT IS MADE OF MS58/MS63 BRASS LOW PRESSURE INGOTS
- PLASTIC CASE
- 2-WAY ROUTER TOOL
- THE ROYTER TOOLS WAS MADE BRASS'S
- 40 BAR PRESSURE RESISTANT CERAMIC CARTRIDGE USED
- INSTALLATION CONNECTIONS ARE G ½"
- HAND SHOWER CONNECTIONS ARE G ½"
- ABS MIRROR
- 200x200 mm SQUARE SHOWER HEAD
- HAND SHOWER
- 150cm SS CHROME PLATED SHOWER PIPE
- 360 ROTARY PIPE
- 40 BAR PRESSURE RESISTANT CERAMIC CARTRIDGE USED
- G 3/8 M-10 40 BAR PRESSURE RESISTANT STEEL BRAIDED FLEX USED

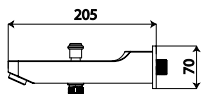

## SERENA ANKASTRE SERİSİ



1 | 9.400,00 ₺  
Code: 26 2010 0004

1 | 10.400,00 ₺  
Code: 26 2010 0005

1 | 9.800,00 ₺  
Code: 26 2010 0006

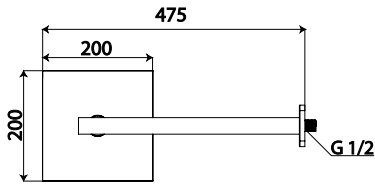

### Ankastre Banyo Batarya Seti

- SIVA ALTI GÖVDE MS58/MS63 ORANINDA ALÇAK BASINÇ PİRİNÇ KÜLÇEDEN ÜRETİLMİŞTİR.
- PLASTİK MUHAFAZALIDIR
- 2 YOLLU YÖNLENDİRİCİ TAKIM
- YÖNLENDİRİCİ TAKIMI MS58 PİRİNÇ MALZEMEDİR
- 40 BAR BASINCA DAYANIKLI SERAMİK KARTUŞ KULLANILMAKTADIR
- TESİSAT BAĞLANTILARI G 1/2' DİR
- EL DUŞU BAĞLANTILARI G 1/2' DİR
- ABS AYNA
- 200X200mm KARE TEPE DUŞU.
- EL DUŞU
- 150cm PASLANMAZ KROM KAPLI DUŞ HORTUMU

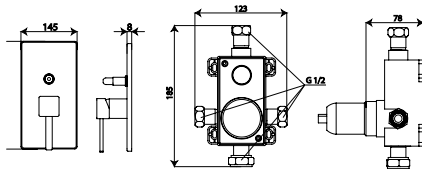

### Built-in Bathroom Faucet Surface Set

- OUR PRODUCT IS MADE OF MS58/MS63 BRASS LOW PRESSURE INGOTS
- PLASTIC CASE
- 2-WAY ROUTER TOOL
- THE ROYTER TOOLS WAS MADE BRASS'S
- 40 BAR PRESSURE RESISTANT CERAMIC CARTRIDGE USED
- INSTALLATION CONNECTIONS ARE G 1/2
- HAND SHOWER CONNECTIONS ARE G 1/2
- ABS MIRROR
- 200x200 mm SQUARE SHOWER HEAD
- HAND SHOWER
- 150cm SS CHROME PLATED SHOWER PIPE
- 360 ROTARY PIPE
- 40 BAR PRESSURE RESISTANT CERAMIC CARTRIDGE USED
- G 3/8 M-10 40 BAR PRESSURE RESISTANT STEEL
- BRAIDED FLEX USED

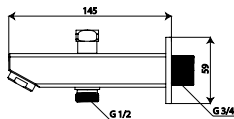

Code: 51 2010 1613

**Roka Ankastrre Tavan Tepe Duşu**  
**Roka Built-in Ceiling Shower Set**

12 1.200,00 ₺



Code: 51 2010 1615

**Serena Ankastrre Tavan Tepe Duşu**  
**Serena Built-in Ceiling Shower Set**

12 1.200,00 ₺



Code: 51 2010 1612

**Roka Ankastrre Tepe Duşu**  
**Roka Built-in Ceiling Shower Set**

12 1.200,00 ₺



Code: 51 2010 1614

**Serena Ankastrre Tepe Duşu**  
**Serena Built-in Ceiling Shower Set**

12 1.200,00 ₺



Code: 51 2010 1608

**Carisma Ankastr Oynar Bařlı Duř**  
**Carisma Built-in Movable**  
**Head Shower Set**

25 830,00 ₺



Code: 51 2010 1609

**Roka Ankastr Oynar Bařlı Duř**  
**Roka Built-in Movable Head**  
**Shower Set**

25 830,00 ₺



Code: 51 2010 1610

**Dünya Ankastr Oynar Bařlı Duř**  
**World Built-in Movable**  
**Head Shower Set**

25 830,00 ₺



Code: 51 2010 1607

**Serena Ankastr Oynar Bařlı Duř**  
**Serena Built-in Movable**  
**Head Shower Set**

25 830,00 ₺



Code: 51 2010 1611

**Dünya Ankastr Oynar Bařlı Duř**  
**World Built-in Movable**  
**Head Shower Set**

25 1.350,00 ₺



Code: 51 2010 1603

**Violet Ankastr Oynar Bařlı Duř**  
**Serena Built-in Movable**  
**Head Shower Set**

25 1.350,00 ₺



Code: 28 2010 0059

**Dünya Duş Paneli**  
**Dünya Shower Set**

1 | 10.800,00 ₺

ÖZELLİKLER:

- Paslanmaz çelik saç gövde
- Ankastr banyo bataryası ve gagası
- 1/2" - 1/2" 150 cm çift kenetli EPDM spiral
- 360° yönlendirici
- Fonksiyonlu el duşu
- Montaj elemanları

FEATURES:

- Stainless steel plate body
- 1/2" - 1/2" 150 cm double interlocking spiral EPDM
- 360° router
- Function hand shower
- Mounting parts



Code: 28 2010 0051

**Dilara Duş Paneli**  
**Dilara Shower Set**

1 | 15.700,00 ₺

ÖZELLİKLER:

- Paslanmaz çelik saç gövde
- Ankastr banyo bataryası ve gagası
- 1/2" - 1/2" 150 cm çift kenetli EPDM spiral
- 360° yönlendirici
- Fonksiyonlu el duşu
- Montaj elemanları

FEATURES:

- Stainless steel plate body
- 1/2" - 1/2" 150 cm double interlocking spiral EPDM
- 360° router
- Function hand shower
- Mounting parts



Code: 28 2010 0061

**Roka Duş Paneli**  
**Roka Shower Set**

1 | 12.800,00 ₺

ÖZELLİKLER:

- Paslanmaz çelik saç gövde
- Ankastr banyo bataryası ve gagası
- 1/2" - 1/2" 150 cm çift kenetli EPDM spiral
- 360° yönlendirici
- Fonksiyonlu el duşu
- Montaj elemanları

FEATURES:

- Stainless steel plate body
- 1/2" - 1/2" 150 cm double interlocking spiral EPDM
- 360° router
- Function hand shower
- Mounting parts



Code: 28 2010 0054

**Smark Duş Paneli**  
**Smark Shower Set**

1 | 10.900,00 ₺

ÖZELLİKLER:

- Paslanmaz çelik saç gövde
- Ankastr banyo bataryası ve gagası
- 1/2" - 1/2" 150 cm çift kenetli EPDM spiral
- 360° yönlendirici
- Fonksiyonlu el duşu
- Montaj elemanları

FEATURES:

- Stainless steel plate body
- 1/2" - 1/2" 150 cm double interlocking spiral EPDM
- 360° router
- Function hand shower
- Mounting parts



Code: 28 2010 0060

**Şato Duş Paneli**  
**Şato Shower Set**
 1 | 12.600,00 ₺

## ÖZELLİKLER:

- Paslanmaz çelik saç gövde
- Ankastr banyo bataryası ve gagası
- 1/2" - 1/2" 150 cm çift kenetli EPDM spiral
- 360° yönlendirici
- Fonksiyonlu el duşu
- Montaj elemanları

## FEATURES:

- Stainless steel plate body
- 1/2" - 1/2" 150 cm double interlocking spiral EPDM
- 360° router
- Function hand shower
- Mounting parts



Code: 28 2010 0053

**Duck Duş Paneli**  
**Duck Shower Set**
 1 | 11.500,00 ₺

## ÖZELLİKLER:

- Paslanmaz çelik saç gövde
- Ankastr banyo bataryası ve gagası
- 1/2" - 1/2" 150 cm çift kenetli EPDM spiral
- 360° yönlendirici
- Fonksiyonlu el duşu
- Montaj elemanları

## FEATURES:

- Stainless steel plate body
- 1/2" - 1/2" 150 cm double interlocking spiral EPDM
- 360° router
- Function hand shower
- Mounting parts

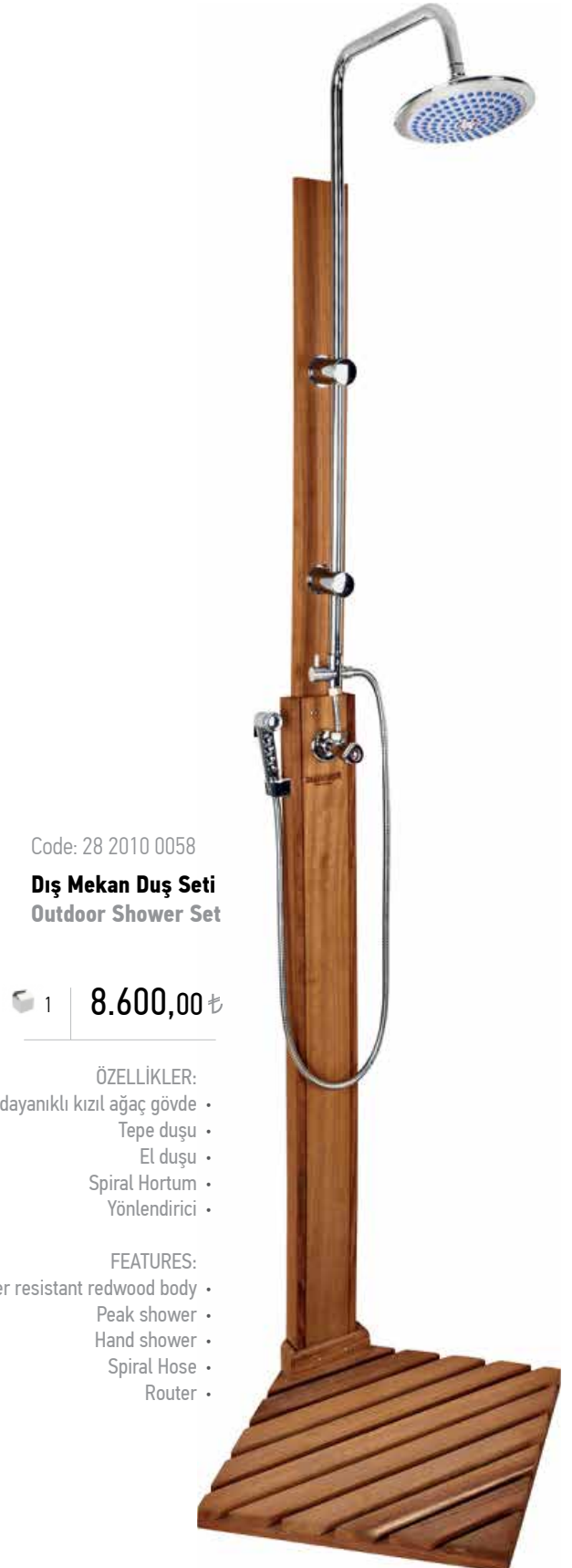

Code: 28 2010 0058

**Dış Mekan Duş Seti**  
**Outdoor Shower Set**
 1 | 8.600,00 ₺

## ÖZELLİKLER:

- Suya dayanıklı kızıl ağaç gövde
- Tepe duşu
- El duşu
- Spiral Hortum
- Yönlendirici

## FEATURES:

- Water resistant redwood body
- Peak shower
- Hand shower
- Spiral Hose
- Router







Code: 30 2010 5008

**Dilara Kırmızı Robot Duş Seti**  
**Dilara Red Robot Shower Set**

10 5.100,00 ₺



Code: 30 2010 5007

**Dilara Siyah Robot Duş Seti**  
**Dilara Black Robot Shower Set**

10 5.100,00 ₺



Code: 30 2010 5009

**Dilara Gri Robot Duş Seti**  
**Dilara Gray Robot Shower Set**

10 5.100,00 ₺

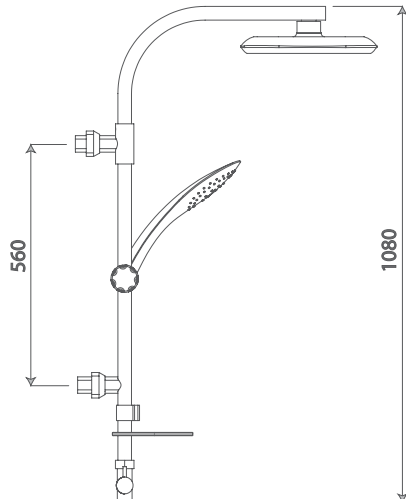

### Robot Duş Seti

- Özel Kesitli Su kolonu
- Krom Duş Başlığı
- Fonksiyonlu El Duşu
- 80 cm Su Girişi Spirali
- 1,5 mt El Duşu Spirali
- 2 Yollu ( Duş Başlığı ve El Duşu ) yönlendirici
- Ürün Yüksekliği 1080 mm
- Duş Başlık Çıkışı 350 mm

### Robot Shower Set

- Special Water Pipe
- Chrome Shower Head
- Functional Hand Shower
- 80 cm Water Inlet Spiral Hose
- 1,5 mt Hand Shower Spiral hose
- 2 Way Router
- Product Height 1080 mm
- Shower Head Output 350 mm

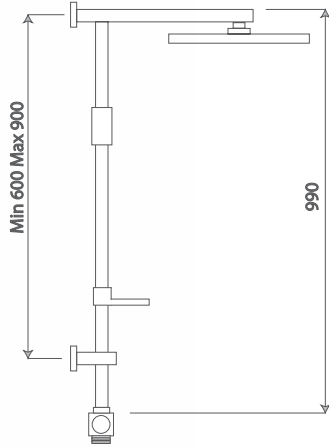
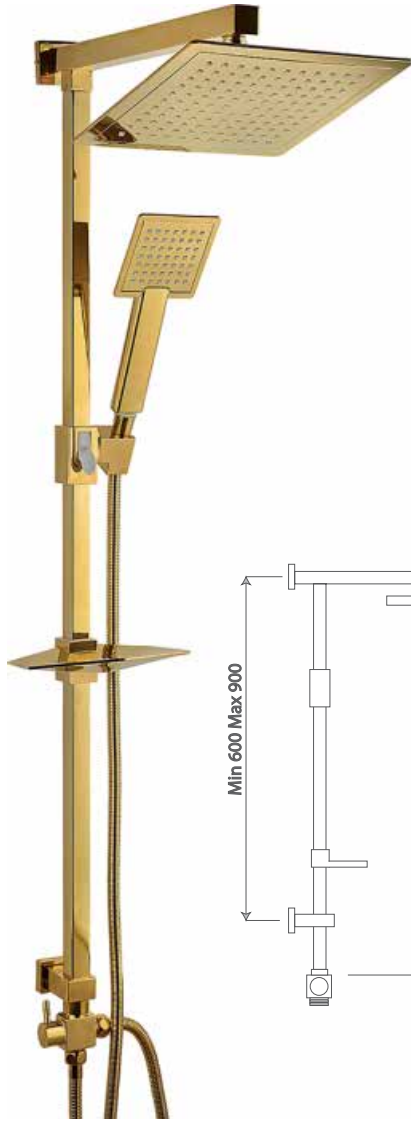

### Sato Kare Robot Duş Seti

- Özel Kesitli Su kolonu
- Krom Duş Başlığı
- Fonsiyonlu El Duşu
- 80 cm Su Girişi Spirali
- 1,5 mt El Duşu Spirali
- 2 Yollu ( Duş Başlığı ve El Duşu ) yönlendirici
- Ürün Yüksekliği 990 mm
- Duş Başlık Çıkışı 300 mm

### Chateau Square Robot Shower Set

- Special Water Pipe
- Chrome Shower Head
- Functional Hand Shower
- 80 cm Water Inlet Spiral Hose
- 1,5 mt Hand Shower Spiral hose
- 2 Way Router
- Product Height 1080 mm
- Shower Head Output 300mm

4 5.900,00 ₺  
Code: 30 2010 5001

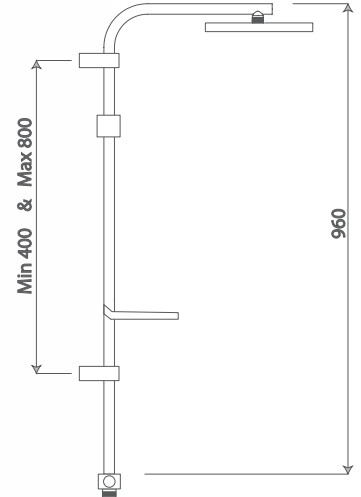
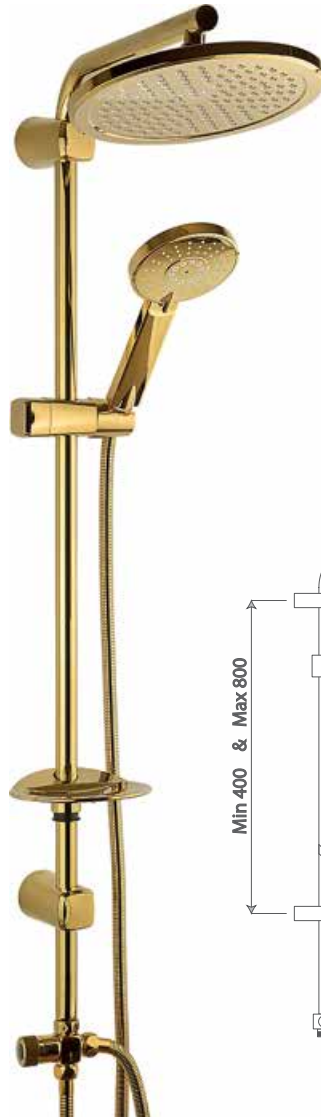

### Dünya Robot Duş Seti

- Özel Kesitli Su kolonu
- Krom Duş Başlığı
- Fonsiyonlu El Duşu
- 80 cm Su Girişi Spirali
- 1,5 mt El Duşu Spirali
- 2 Yollu ( Duş Başlığı ve El Duşu ) yönlendirici
- Ürün Yüksekliği 960 mm
- Duş Başlık Çıkışı 300 mm

### Word Robot Shower Set

- Special Water Pipe
- Chrome Shower Head
- Functional Hand Shower
- 80 cm Water Inlet Spiral Hose
- 1,5 mt Hand Shower Spiral hose
- 2 Way Router
- Product Height 1080 mm
- Shower Head Output 300 mm

4 5.900,00 ₺  
Code: 30 2010 5016

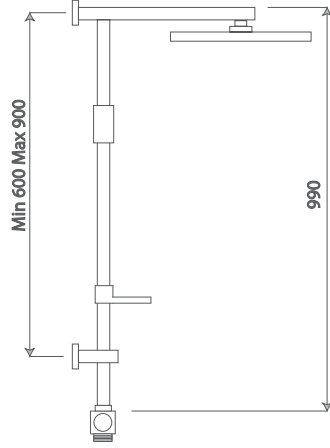
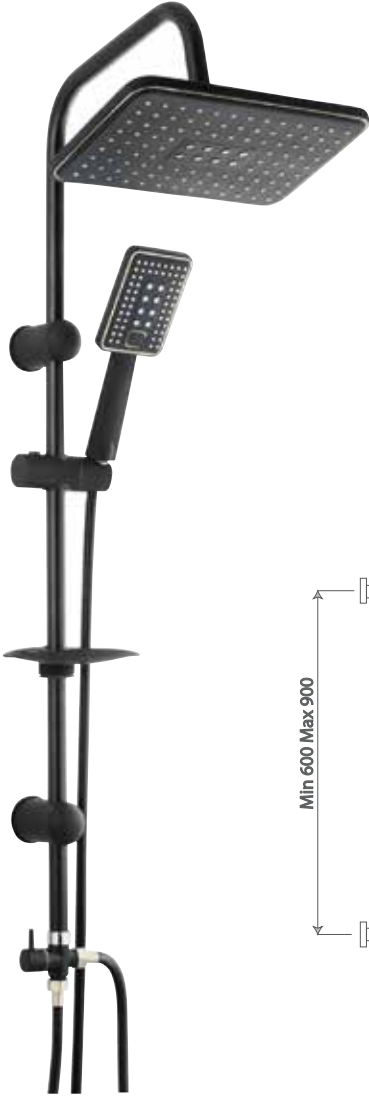
**Sato Kare Robot Duş Seti**

- Özel Kesitli Su kolonu
- Krom Duş Başlığı
- Fonsiyonlu El Duşu
- 80 cm Su Girişi Spirali
- 1,5 mt El Duşu Spirali
- 2 Yollu ( Duş Başlığı ve El Duşu ) yönlendirici
- Ürün Yüksekliği 990 mm
- Duş Başlık Çıkışı 300 mm

**Chateau Square Robot Shower Set**

- Special Water Pipe
- Chrome Shower Head
- Functional Hand Shower
- 80 cm Water Inlet Spiral Hose
- 1,5 mt Hand Shower Spiral hose
- 2 Way Router
- Product Height 1080 mm
- Shower Head Output 300mm



4.900,00 ₺

Code: 30 2010 5030

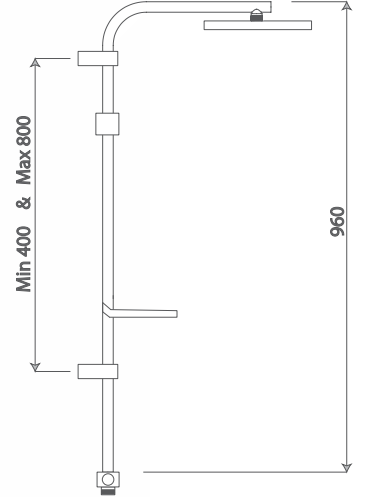
**Dünya Robot Duş Seti**

- Özel Kesitli Su kolonu
- Krom Duş Başlığı
- Fonsiyonlu El Duşu
- 80 cm Su Girişi Spirali
- 1,5 mt El Duşu Spirali
- 2 Yollu ( Duş Başlığı ve El Duşu ) yönlendirici
- Ürün Yüksekliği 960 mm
- Duş Başlık Çıkışı 300 mm

**Word Robot Shower Set**

- Special Water Pipe
- Chrome Shower Head
- Functional Hand Shower
- 80 cm Water Inlet Spiral Hose
- 1,5 mt Hand Shower Spiral hose
- 2 Way Router
- Product Height 1080 mm
- Shower Head Output 300 mm



4.900,00 ₺

Code: 30 2010 5031



Code: 30 2010 5025

**Polo Gri Robot Duş Seti**  
**Polo Gray Robot Shower Set**

5 7.600,00 ₺



Code: 30 2010 5026

**Polo Beyaz Robot Duş Seti**  
**Polo White Robot Shower Set**

5 7.600,00 ₺



Code: 30 2010 5027

**Polo Kırmızı Robot Duş Seti**  
**Polo Red Robot Shower Set**

5 7.600,00 ₺

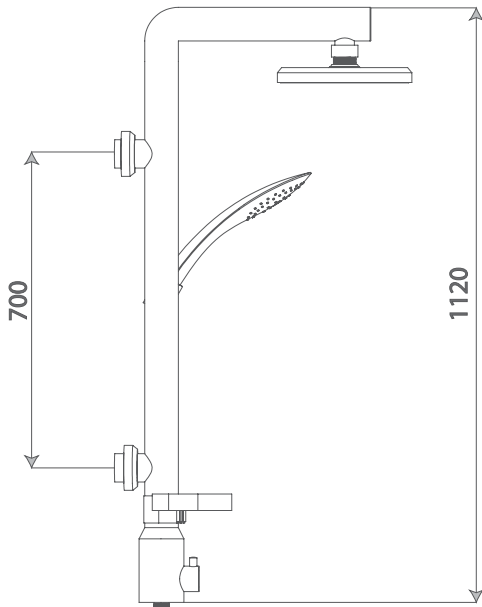

**Polo Robot Duş Seti**

- Özel Kesitli Su kolonu
- Krom Duş Başlığı
- Fonksiyonlu El Duşu
- 80 cm Su Girişi Spirali
- 1,5 mt El Duşu Spirali
- 2 Yollu ( Duş Başlığı ve El Duşu ) yönlendirici
- Ürün Yüksekliği 1120 mm
- Duş Başlık Çıkışı 350 mm

**Polo Robot Shower Set**

- Special Water Pipe
- Chrome Shower Head
- Functional Hand Shower
- 80 cm Water Inlet Spiral Hose
- 1,5 mt Hand Shower Spiral hose
- 2 Way Router
- Product Height 1120 mm
- Shower Head Output 350 mm



Code: 30 2010 5013

**Serena Robot Duş Seti**  
**Serena Robot Shower Set**

6 2.650,00 ₺



Code: 30 2010 5017

**Roka Robot Duş Seti**  
**Roka Robot Shower Set**

6 2.650,00 ₺



Code: 30 2010 5018

**Duck Robot Duş Seti**  
**Duck Robot Shower Set**

6 2.650,00 ₺



Code: 30 2010 5028

**Eko Kare Robot Duş Seti**  
**Eco Robot Shower Set**

5 1.650,00 ₺



Code: 30 2010 5029

**Eko Oval Robot Duş Seti**  
**Eco Robot Shower Set**

5 1.650,00 ₺

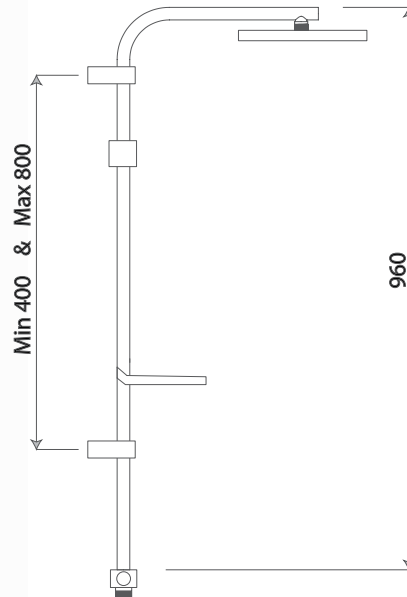

### Robot Duş Seti

- Özel Kesitli Su kolonu
- Krom Duş Başlığı
- Fonsiyonlu El Duşu
- 80 cm Su Girişi Spirali
- 1,5 mt El Duşu Spirali
- 2 Yollu ( Duş Başlığı ve El Duşu ) yönlendirici
- Ürün Yüksekliği 690 mm
- Duş Başlık Çıkışı 300 mm

### Robot Shower Set

- Special Water Pipe
- Chrome Shower Head
- Functional Hand Shower
- 80 cm Water Inlet Spiral Hose
- 1,5 mt Hand Shower Spiral hose
- 2 Way Router
- Product Height 960 mm
- Shower Head Output 300 mm

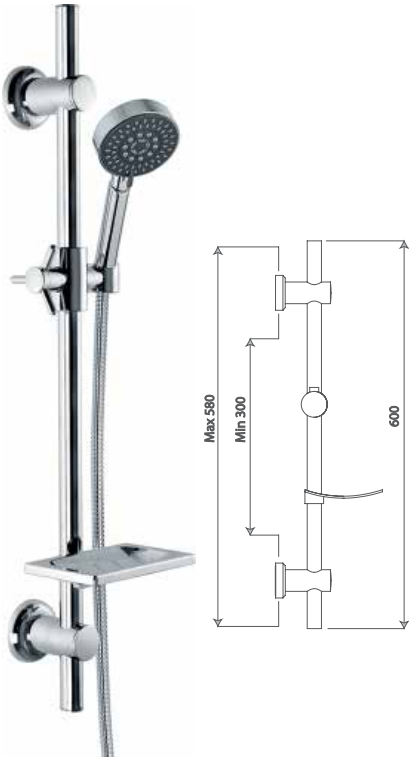

Code: 49 2010 1409

**Serena Sürgülü Duş Seti (Spirali Örgülü)**

Serena Sliding Syst. Shower Set 12 950,00 ₺

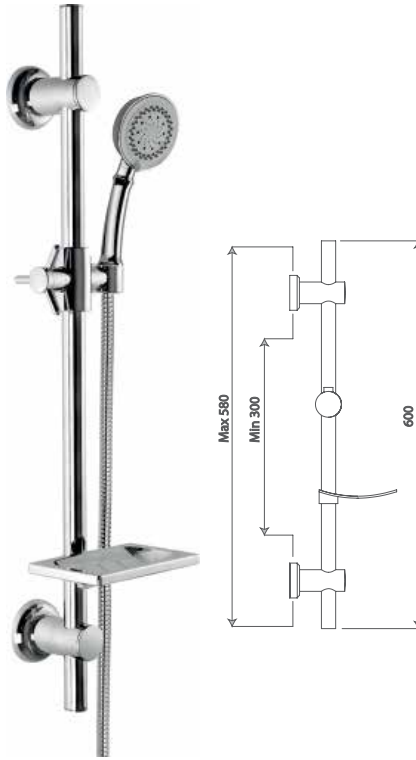

Code: 49 2010 1452

**Dünya Sürgülü Duş Seti (Spirali Örgülü)**

Dünya Sliding Syst. Shower Set 12 950,00 ₺

### Lux Sürgülü Duş Seti

- Lux Kromlu Sürgü
- Fonksiyonlu El Duşu
- 1,5 mt El Duşu Spirali
- Ürün Yüksekliği 600 mm

### Lux Sliding Syst. Shower Set

- Lux Chrome Pipe
- Functional Hand Shower
- 1,5 mt Hand Shower Spiral hose
- Product Height 600 mm



Code: 49 2010 1509

**Duck Sürgülü Duş Seti (Spirali Örgülü) Duck**

Sliding System Shower Set 12 950,00 ₺



Code: 49 2010 1415

**Roka Sürgülü Duş Seti (Spirali Örgülü)**

Roka Sliding System Shower Set 12 900,00 ₺

### Lux Sürgülü Duş Seti

- Lux Kromlu Sürgü
- Fonksiyonlu El Duşu
- 1,5 mt El Duşu Spirali
- Ürün Yüksekliği 600 mm

### Lux Sliding Syst. Shower Set

- Lux Chrome Pipe
- Functional Hand Shower
- 1,5 mt Hand Shower Spiral hose
- Product Height 600 mm

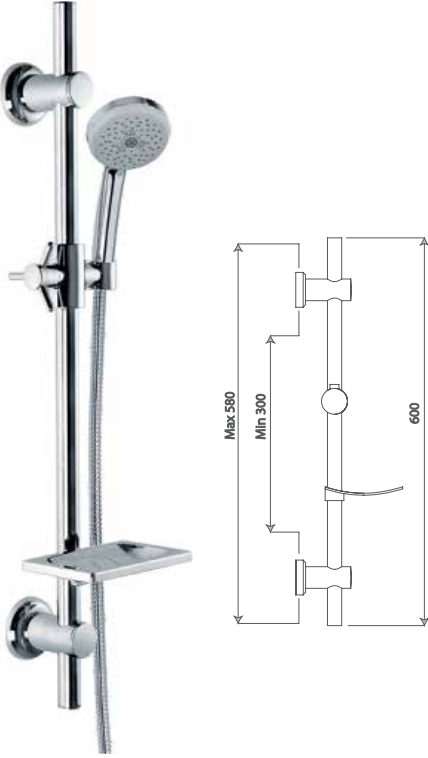

Code: 49 2010 1460

**Polo Sürgülü Duş Seti (Spirali Örgülü)**

Polo Sliding System Shower Set 12 900,00 ₺

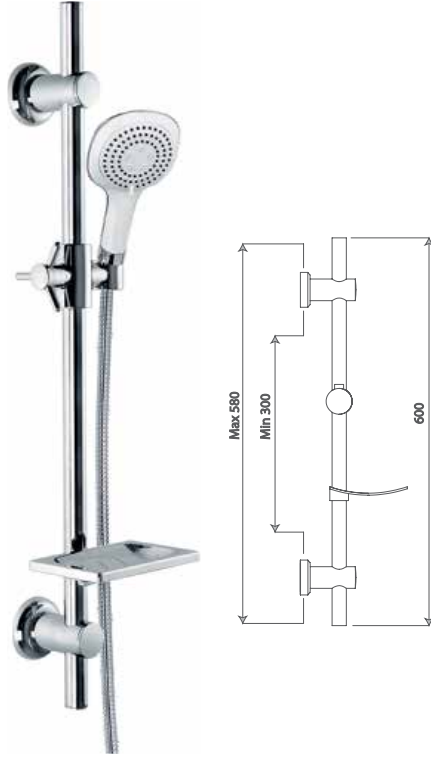

Code: 49 2010 1403

**Dilara Sürgülü Duş Seti (Spirali Örgülü)**

Dilara Sliding Syst. Shower Set 12 900,00 ₺

### Lüks Sürgülü Duş Seti

- Lüks Kromlu Sürgü
- Fonksiyonlu El Duşu
- 1,5 mt El Duşu Spirali
- Ürün Yüksekliği 600 mm

### Lux Sliding Syst. Shower Set

- Lux Chrome Pipe
- Functional Hand Shower
- 1,5 mt Hand Shower Spiral hose
- Product Height 600 mm



Code: 50 2010 1519

**Koç Sürgülü Duş Seti (Spirali Örgülü)**

Koç Sliding System Shower Set 12 1.300,00 ₺

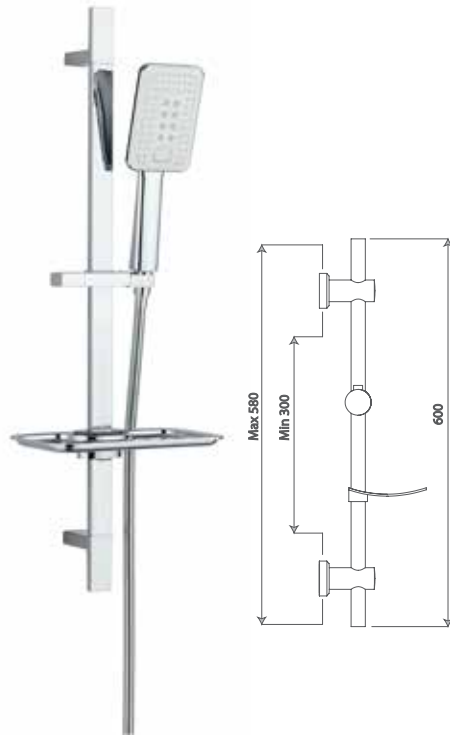

Code: 50 2010 1520

**Smarm Sürgülü Duş Seti (Spirali Örgülü)**

Smarm Sliding System Shower Set 12 1.300,00 ₺

### Lüks Sürgülü Duş Seti

- Lüks Kromlu Sürgü
- Fonksiyonlu El Duşu
- 1,5 mt El Duşu Spirali
- Ürün Yüksekliği 600 mm

### Lux Sliding Syst. Shower Set

- Lux Chrome Pipe
- Functional Hand Shower
- 1,5 mt Hand Shower Spiral hose
- Product Height 600 mm



Code: 49 2010 1425

**Lara Sürgülü Duş Seti**  
**Lara Sliding System Shower Set**

12 620,00 ₺



Code: 49 2010 1418

**Mars Sürgülü Duş Seti (Spirali Örgülü)**  
**Mars Sliding System Shower Set**

12 620,00 ₺

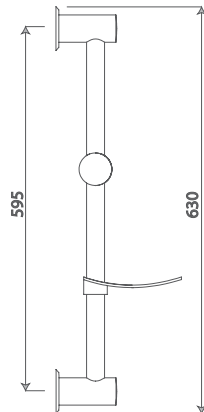

**Sürgülü Duş Seti**

- Kromlu Sürgü
- Fonksiyonlu El Duşu
- 1,5 mt El Duşu Spirali
- Ürün Yüksekliği 630 mm

**Sliding Syst. Shower Set**

- Chrome Pipe
- Functional Hand Shower
- 1,5 mt Hand Shower Spiral hose
- Product Height 630 mm





Code: 49 2010 1451

**Kare Sürgülü Duş Seti (Spirali Örgülü)**  
**Kare Sliding System Shower Set**



12

620,00 ₺



Code: 49 2010 1419

**Şampuanlı Sürgülü Duş Seti**  
**Sliding System Shower Set With Shampoo Holde**



12

940,00 ₺

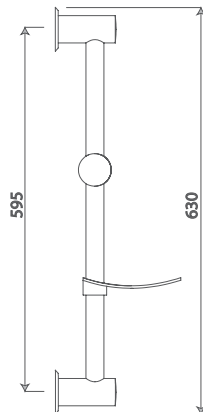

**Sürgülü Duş Seti**

- Kromlu Sürgü
- Fonksiyonlu El Duşu
- 1,5 mt El Duşu Spirali
- Ürün Yüksekliği 630 mm

**Sliding Syst. Shower Set**

- Chrome Pipe
- Functional Hand Shower
- 1,5 mt Hand Shower Spiral hose
- Product Height 630 mm



### Lux Mafsallı Duş Seti

- Lux Mafsal
- Fonksiyonlu El Duşu
- 1,5 mt El Duşu Spirali



### Lux Wall Brachet Shower Set

- Lux Wall Brachet
- Functional Hand Shower
- 1,5 mt Hand Shower Spiral hose

Code: 50 2010 1523

### Venus Mafsallı Duş Seti - İpli

Venus Wall Bracket Shower Set 24

730,00 ₺

### Lux Mafsallı Duş Seti

- Lux Mafsal
- Fonksiyonlu El Duşu
- 1,5 mt El Duşu Spirali



### Lux Wall Brachet Shower Set

- Lux Wall Brachet
- Functional Hand Shower
- 1,5 mt Hand Shower Spiral hose

Code: 49 2010 1408

### Serena Mafsallı Duş Seti - İpli

Serena Wall Bracket Shower Set 24

600,00 ₺

### Lux Mafsallı Duş Seti

- Lux Mafsal
- Fonksiyonlu El Duşu
- 1,5 mt El Duşu Spirali



### Lux Wall Brachet Shower Set

- Lux Wall Brachet
- Functional Hand Shower
- 1,5 mt Hand Shower Spiral hose

Code: 49 2010 1453

### Dünya Mafsallı Duş Seti - İpli

World Wall Bracket Shower Set 24

600,00 ₺

### Lux Mafsallı Duş Seti

- Lux Mafsal
- Fonksiyonlu El Duşu
- 1,5 mt El Duşu Spirali



### Lux Wall Brachet Shower Set

- Lux Wall Brachet
- Functional Hand Shower
- 1,5 mt Hand Shower Spiral hose

Code: 49 2010 1402

### Dilara Mafsallı Duş Seti - İpli

Dilara Wall Bracket Shower Set 24

600,00 ₺

**Lüks Mafsalı Duş Seti**

- Lüks Mafsal
- Fonksiyonlu El Duşu
- 1,5 mt El Duşu Spirali

**Lux Wall Bracket Shower Set**

- Lux Wall Bracket
- Functional Hand Shower
- 1,5 mt Hand Shower Spiral hose

Code: 49 2010 1414

**Roka Mafsalı Duş Seti - İpli****Roka Wall Bracket Shower Set**

570,00 ₺

**Lüks Mafsalı Duş Seti**

- Lüks Mafsal
- Fonksiyonlu El Duşu
- 1,5 mt El Duşu Spirali

**Lux Wall Bracket Shower Set**

- Lux Wall Bracket
- Functional Hand Shower
- 1,5 mt Hand Shower Spiral hose

Code: 49 2010 1411

**Violet Mafsalı Duş Seti - İpli****Violet Wall Bracket Shower Set**

570,00 ₺

**Lüks Mafsalı Duş Seti**

- Lüks Mafsal
- Fonksiyonlu El Duşu
- 1,5 mt El Duşu Spirali

**Lux Wall Bracket Shower Set**

- Lux Wall Bracket
- Functional Hand Shower
- 1,5 mt Hand Shower Spiral hose

Code: 49 2010 1437

**Duck Mafsalı Duş Seti - İpli****Duck Wall Bracket Shower Set**

590,00 ₺

**Lüks Mafsalı Duş Seti**

- Lüks Mafsal
- Fonksiyonlu El Duşu
- 1,5 mt El Duşu Spirali

**Lux Wall Bracket Shower Set**

- Lux Wall Bracket
- Functional Hand Shower
- 1,5 mt Hand Shower Spiral hose

Code: 49 2010 1427

**Lara Mafsalı Duş Seti - İpli****Lara Wall Bracket Shower Set**

590,00 ₺



Code: 49 2010 1417

**Mars Mafsalı Duş Seti**  
Mars Wall Bracket Shower Set



24

390,00 ₺



Code: 49 2010 1421

**Kare Mafsallı Duş Seti**  
Square Wall Bracket Shower Set

24 390,00 ₺



Code: 49 2010 1438

**Klasik Mafsallı Duş Seti**  
Classic Wall Bracket Shower Set

24 230,00 ₺



Code: 49 2010 1439

**Şelale Mafsallı Duş Seti**  
Waterfall Wall Bracket Shower Set

24 230,00 ₺



Code: 49 2010 1416

**Mars El Duşu**  
**Mars Hand Shower**

24 170,00 ₺



Code: 49 2010 1423

**Lara El Duşu**  
**Lara Hand Shower**

24 170,00 ₺



Code: 49 2010 1420

**Kare El Duşu**  
**Kare Hand Shower**

24 170,00 ₺



Code: 50 2010 1505

**Şelale El Duşu**  
**Şelale Hand Shower**

24 170,00 ₺



Code: 49 2010 1410

**Violet El Duşu**  
**Violet Hand Shower**

24 199,00 ₺



Code: 49 2010 1407

**Serena El Duşu**  
**Serena Hand Shower**

24 199,00 ₺



Code: 49 2010 1413

**Roka El Duşu**  
**Roka Hand Shower**

24 199,00 ₺



Code: 50 2010 1515

**Stil El Duşu**  
**Stil Hand Shower**

24 199,00 ₺



Code: 30 2010 5020

**Dilara El Duşu**  
**Dilara Hand Shower**

24 199,00 ₺



Code: 49 2010 1401

**Duck El Duşu**  
**Dark Hand Shower**

24 199,00 ₺



Code: 49 2010 1458

**Dünya El Duşu**  
**World Hand Shower**

24 199,00 ₺



Code: 49 2010 1459

**Carisma El Duşu**  
**Carisma Hand Shower**

24 199,00 ₺

El Duşu  
Mafsal  
Spiral



Code: 50 2010 1510

**Lara Shattaf Takım**  
Lara Shattaf Shower Set

50 760,00 ₺

El Duşu  
Mafsal  
Spiral



Code: 50 2010 1511

**Violet Shattaf Takım**  
Violet Shattaf Shower Set

50 700,00 ₺



Code: 50 2010 1501

**Spiralli El Duşu**  
Spiral Hand Shower

24 320,00 ₺

Code: 48 2010 1310

**1/2-1/2 Antik Osmanlı  
Spiral Hortum**  
1/2-1/2 Antique Ottoman  
Spiral Hose

50 260,00 ₺



Code: 50 2010 1507

**1/2-1/2 Lüks Serena Çift Kenetli  
Spiralli Hortum**  
1/2-1/2 Lux Serena Double  
Lock Spiral Hose

50 250,00 ₺



Code: 50 2010 1506

**1/2-1/2 Lara Çift Kenetli  
Spiralli Hortum**  
1/2-1/2 Lara Double  
Lock Spiral Hose

Ekonomik

50 190,00 ₺



Code: 50 2010 1508

**1/2-1/2 M10 Mix Berber Spiralli Hortum**  
1/2-1/2 M10 Mix Barber Spiral Hose

50 250,00 ₺





	Kod	Ürün	Ebat	Fiyat	Koli Adeti
	53 2010 1801	3/8 - 3/8 Bağlantı Borusu	20 cm	74,00	30
	53 2010 1802	3/8 - 3/8 Bağlantı Borusu	30 cm	82,00	30
	53 2010 1803	3/8 - 3/8 Bağlantı Borusu	40 cm	89,00	30
	53 2010 1804	3/8 - 3/8 Bağlantı Borusu	50 cm	97,20	25
	53 2010 1805	3/8 - 3/8 Bağlantı Borusu	60 cm	104,00	25
	53 2010 1806	3/8 - 3/8 Bağlantı Borusu	70 cm	113,00	25
	53 2010 1807	3/8 - 3/8 Bağlantı Borusu	80 cm	119,00	20
	53 2010 1808	3/8 - 3/8 Bağlantı Borusu	90 cm	127,00	15
	53 2010 1809	3/8 - 3/8 Bağlantı Borusu	100 cm	135,00	15
	53 2010 1810	1/2 - 3/8 Bağlantı Borusu	30 cm	91,00	30
	53 2010 1811	1/2 - 3/8 Bağlantı Borusu	40 cm	94,00	30
	53 2010 1812	1/2 - 3/8 Bağlantı Borusu	50 cm	108,00	25
	53 2010 1813	1/2 - 3/8 Bağlantı Borusu	60 cm	115,00	25
	53 2010 1814	1/2 - 3/8 Bağlantı Borusu	70 cm	126,00	25
	53 2010 1815	1/2 - 3/8 Bağlantı Borusu	80 cm	130,00	20
	53 2010 1816	1/2 - 3/8 Bağlantı Borusu	90 cm	139,00	15
	53 2010 1817	1/2 - 3/8 Bağlantı Borusu	100 cm	145,00	15
	53 2010 1818	1/2 - 1/2 Bağlantı Borusu	30 cm	102,00	30
	53 2010 1819	1/2 - 1/2 Bağlantı Borusu	40 cm	110,00	30
	53 2010 1820	1/2 - 1/2 Bağlantı Borusu	50 cm	117,00	25
	53 2010 1821	1/2 - 1/2 Bağlantı Borusu	60 cm	125,00	25
	53 2010 1822	1/2 - 1/2 Bağlantı Borusu	70 cm	132,00	25
	53 2010 1823	1/2 - 1/2 Bağlantı Borusu	80 cm	141,00	20
	53 2010 1824	1/2 - 1/2 Bağlantı Borusu	90 cm	146,00	15
	53 2010 1825	1/2 - 1/2 Bağlantı Borusu	100 cm	156,00	15
	53 2010 1826	1/2 - 3/4 Bağlantı Borusu	30 cm	145,00	30
	53 2010 1827	1/2 - 3/4 Bağlantı Borusu	40 cm	153,00	30
	53 2010 1828	1/2 - 3/4 Bağlantı Borusu	50 cm	160,00	25
	53 2010 1829	1/2 - 3/4 Bağlantı Borusu	60 cm	167,00	25
	53 2010 1830	1/2 - 3/4 Bağlantı Borusu	70 cm	175,00	25
	53 2010 1831	1/2 - 3/4 Bağlantı Borusu	80 cm	184,00	20
	53 2010 1832	1/2 - 3/4 Bağlantı Borusu	90 cm	191,00	15
	53 2010 1833	1/2 - 3/4 Bağlantı Borusu	100 cm	199,00	15
		53 2010 1834	3/4 - 3/4 Bağlantı Borusu	30 cm	190,00
53 2010 1835		3/4 - 3/4 Bağlantı Borusu	40 cm	195,00	30
53 2010 1836		3/4 - 3/4 Bağlantı Borusu	50 cm	204,00	25
53 2010 1837		3/4 - 3/4 Bağlantı Borusu	60 cm	210,00	25
53 2010 1838		3/4 - 3/4 Bağlantı Borusu	70 cm	220,00	25
53 2010 1839		3/4 - 3/4 Bağlantı Borusu	80 cm	225,00	-
53 2010 1840		3/4 - 3/4 Bağlantı Borusu	90 cm	234,00	-
53 2010 1841		3/4 - 3/4 Bağlantı Borusu	100 cm	241,00	-
		53 2010 1842	3/8 M-10 Kartal Alt Bağlantısı	40 cm	74,00
	53 2010 1843	3/8 M-10 Kartal Alt Bağlantısı	50 cm	82,00	25
	53 2010 1844	3/8 M-10 Kartal Alt Bağlantısı	60 cm	89,00	25
	53 2010 1845	3/8 M-10 Kartal Alt Bağlantısı	70 cm	99,00	25
	53 2010 1891	3/8 M-10 Kartal Alt Bağlantısı	80 cm	104,00	15
	53 2010 1892	3/8 M-10 Kartal Alt Bağlantısı	90 cm	114,00	15
	53 2010 1893	3/8 M-10 Kartal Alt Bağlantısı	100 cm	234,00	15
	53 2010 1846	3/8 M-10 Kartal Alt Bağ. Borusu (Uzun Başlı)	40 cm	-----	-
	53 2010 1847	3/8 - 3/8 Erkek Nipelli	30 cm	88,00	30
	53 2010 1848	3/8 - 3/8 Erkek Nipelli	40 cm	95,00	30
	53 2010 1849	3/8 - 3/8 Erkek Nipelli	50 cm	102,00	25
	53 2010 1850	1/2 - 1/2 Erkek Nipelli	30 cm	110,00	30
	53 2010 1851	1/2 - 1/2 Erkek Nipelli	40 cm	--	30
	53 2010 1852	1/2 - 1/2 Erkek Nipelli	50 cm	--	25

46 2010 5001	WOYA KUMANDA KOLU (YÖNLENDİRİCİ TAKIMI)	190,00 TL
46 2010 5002	WOYA BANYO YÖNLENDİRİCİ TAKIM	162,00 TL
46 2010 5003	WOYA UZUN BORU	200,00 TL
46 2010 5004	WOYA KISA BORU	200,00 TL
46 2010 5005	WOYA ALT BAĞLANTI TAKIMI ( M8 )	35,00 TL
25 2010 3100	ELİT KUMANDA KOLU	267,00 TL
25 2010 3161	ELİT BANYO YÖNLENDİRİCİ TAKIM	230,00 TL
25 2010 3101	ELİT UZUN BORU	280,00 TL
25 2010 3102	ELİT KISA BORU	280,00 TL
25 2010 3103	ELİT ALT BAĞLANTI TAKIMI ( M8 )	87,00 TL
25 2010 3104	MOCCA KUMANDA KOLU	242,00 TL
25 2010 3105	MOCCA BANYO YÖNLENDİRİCİ TAKIM	230,00 TL
25 2010 3106	MOCCA UZUN BORU ( 28°LİK BORU )	280,00 TL
25 2010 3107	MOCCA KISA BORU	280,00 TL
25 2010 3108	MOCCA ALT BAĞLANTI TAKIMI ( M8 )	87,00 TL
25 2010 3109	SPECKTRA KUMANDA KOLU	242,00 TL
25 2010 3110	SPECKTRA BANYO YÖNLENDİRİCİ TAKIM	190,00 TL
25 2010 3111	SPECKTRA UZUN BORU	280,00 TL
25 2010 3112	SPECKTRA KISA BORU	280,00 TL
25 2010 3113	SPECKTRA ALT BAĞLANTI TAKIMI ( M8 )	91,00 TL
25 2010 3117	ARMİNE KUMANDA KOLU	200,00 TL
25 2010 3118	ARMİNE BANYO YÖNLENDİRİCİ TAKIM	160,00 TL
25 2010 3050	ARMİNE UZUN BORU	280,00 TL
25 2010 3051	ARMİNE KISA BORU	280,00 TL
25 2010 3119	ARMİNE ALT BAĞLANTI TAKIMI ( M8 )	91,00 TL
25 2010 3120	ROKA KUMANDA KOLU	225,00 TL
25 2010 3121	ROKA BANYO YÖNLENDİRİCİ TAKIM	228,00 TL
25 2010 3054	ROKA UZUN BORU	295,00 TL
25 2010 3055	ROKA KISA BORU	295,00 TL
25 2010 3122	ROKA ALT BAĞLANTI TAKIMI ( M8 )	91,00 TL
25 2010 3123	ROKA TEMİZ SU MUTFAK BATARYA BORUSU COBRA	300,00 TL
25 2010 3124	ROKA TEMİZ SU MUTFAK BATARYA BORUSU BASTON	300,00 TL
25 2010 3125	ROKA TEMİZ SU MUTFAK BATARYA ALT TAKIM ( M6 )	210,00 TL
25 2010 3126	DİLARA KUMANDA KOLU	267,00 TL
25 2010 3127	DİLARA BANYO YÖNLENDİRİCİ TAKIM	270,00 TL
25 2010 3128	DİLARA UZUN BORU	300,00 TL
25 2010 3129	DİLARA KISA BORU	300,00 TL
25 2010 3130	DİLARA ALT BAĞLANTI TAKIMI ( M8 )	90,00 TL
25 2010 3131	POLO KUMANDA KOLU	247,00 TL
25 2010 3132	POLO BANYO YÖNLENDİRİCİ TAKIM	249,00 TL
25 2010 3133	POLO UZUN BORU	1.380,00 TL
25 2010 3134	POLO ALT BAĞLANTI TAKIMI ( M8 )	91,00 TL
25 2010 3135	DUCK KUMANDA KOLU	267,00 TL
25 2010 3136	DUCK BANYO YÖNLENDİRİCİ TAKIM	259,00 TL
25 2010 3137	DUCK UZUN BORU	1.990,00 TL
25 2010 3138	DUCK KISA BORU	1.900,00 TL
25 2010 3139	DUCK ALT BAĞLANTI TAKIMI ( M8 )	91,00 TL
25 2010 3140	SERENA KUMANDA KOLU	247,00 TL
25 2010 3141	SERENA BANYO YÖNLENDİRİCİ TAKIM	280,00 TL
25 2010 3142	SERENA UZUN BORU	320,00 TL
25 2010 3143	SERENA KISA BORU	320,00 TL
25 2010 3144	SERENA ALT BAĞLANTI TAKIMI ( M8 )	90,00 TL
25 2010 3058	3/4 DİRSEK TAKIMI	630,00 TL
25 2010 3059	3/4 BATARYA SOMUNU	170,00 TL
25 2010 3060	3/8 BATARYA SOL NİPELİ	80,00 TL
25 2010 3070	3/4 BATARYA AYNASI	67,00 TL
25 2010 3072	1/2 MUSLUK AYNASI	13,00 TL
54 2010 5522	1/2 BÜYÜK MUSLUK AYNASI	21,00 TL
25 2010 3081	3/4 MUSLUK AYNASI	21,00 TL
25 2010 3075	(3/8) TAHARET MUSLUK SALMASTRASI	91,00 TL
25 2010 3079	LÜX MAFSAL	210,00 TL
25 2010 3080	MAFSAL	70,00 TL



