

# MAXIFLOW

Maksimum akış...

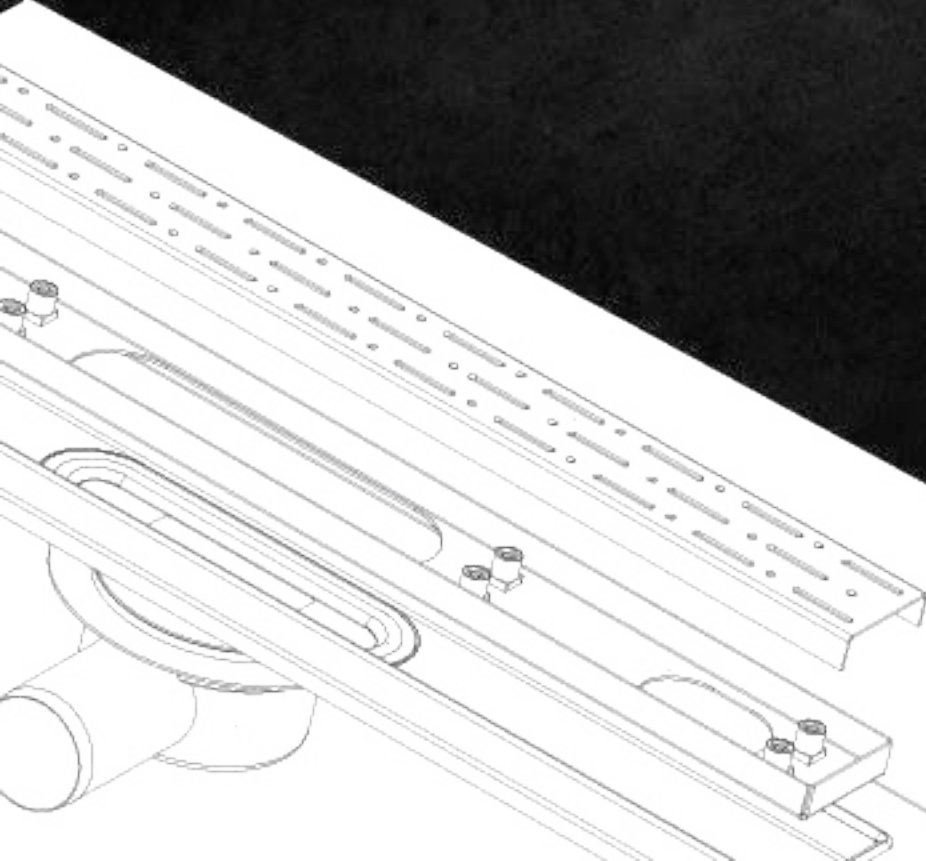

FİYAT  
LİSTESİ | 22



---

## FİYAT LİSTESİ

---

2022/1

*Fiyatlarımızdaki baskı ve dizgi aşamasında ortaya çıkabilecek sorunlarda "MERTİNOKS A.Ş." sorumlu değildir.  
"MERTİNOKS A.Ş." fiyatlarda ve görsellerde her türlü değişiklik yapma hakkına sahiptir.*

# iNDEX

**YER SIFONLARI**

**04**

**DUŞ KANALLARI**

**24**

**DRENAJ KANALLARI**

**70**

**ENGELLİ SERİSİ**

**80**

**ÇÖP KOVALARI**

**86**

**WC FIRÇALIKLAR**

**102**

**DUŞ SETLERİ**

**106**

**AKSESUARLAR**

**122**

# İKON AÇIKLAMALARI



Yan Çıkış



File Montajlı



Alt Çıkış



Tekstil Membran Montajlı



İç Mekan



Bitüm Membran Montajlı



Dış Mekan



Düşük Yoğunluk Su Akışı



Sıcak - Soğuk Çalışma Ortamı



Yüksek Yoğunluk Su Akışı



Banyo (Islak Hacim)



Kilitli Sistem

## EKO 10X10

Ürün Kodu	Kısa Kod	Çıkış	Ölçü	Fiyat
<b>YAN ÇIKIŞ</b>				
3011.0Y050K.010.1	26583	Ø 50	10x10 cm	100
				31.40

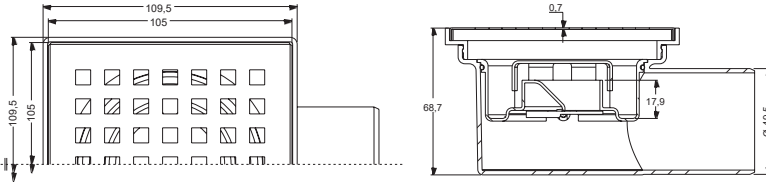

- Plastik gövde
- Paslanmaz ızgara
- Sulu koku tutucu

## LINE 10x10

Ürün Kodu	Kısa Kod	Çıkış	Ölçü	Fiyat
<b>YAN ÇIKIŞ</b>				
3012.0Y032K.010.1	13795	Ø 32	10x10 cm	160
3012.0Y040K.010.1	13800	Ø 40	10x10 cm	100
3012.0Y050K.010.1	13805	Ø 50	10x10 cm	100
3012.0Y070K.010.1	13812	Ø 70	10x10 cm	80
<b>ALT ÇIKIŞ</b>				
3012.0A040K.010.1	13818	Ø 40	10x10 cm	140
3012.0A050K.010.1	13826	Ø 50	10x10 cm	140
3012.0A070K.010.1	13832	Ø 70	10x10 cm	140
<b>ELİTE LEGAL</b>				
3012.0Y032K.010.B	28909	Ø 32	10x10 cm	40
3012.0Y050K.010.B	28910	Ø 50	10x10 cm	40

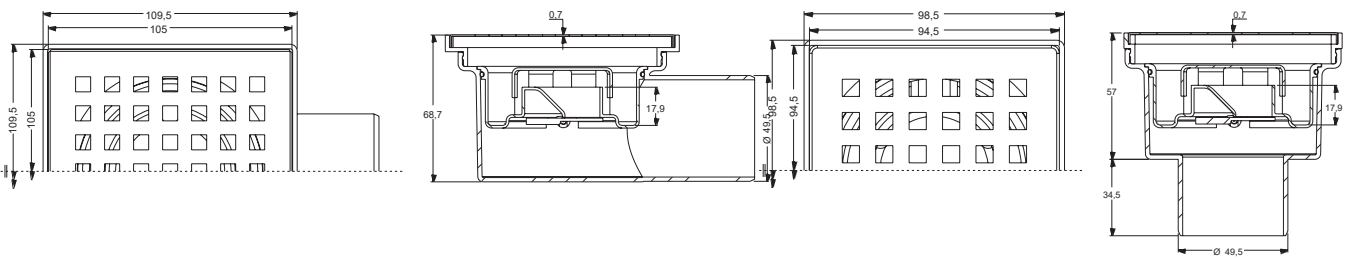

- Plastik gövde
- Paslanmaz ızgara
- Sulu koku tutucu
- Klepeli

### Detaylar

DN 50 Yan ve Alt çıkış – Pvc boru bağlantılarına uyumludur. Akış hızı 32 lt/dk'dır. Iızgarası 304 kalite paslanmaz çeliktir.

### Avantajlar

304 kalite paslanmaz çelik ızgarası sayesinde şık ve kaliteli bir görünüme sahiptir. Duvar dibi uygulamalarda rahatlıkla uygulanabilir. Su tutuculu koku önleyici sayesinde tesisattan gelecek kötü kokuları önler. Yükseltme ayakları sayesinde şapın yüksekliğine göre ayarlama olanağı sağlar. Organik ve inorganik kimyasallara yüksek dayanım. çoğu asidik ve tuzlu su oksidasyonuna dayanıklıdır.

### Kullanım Alanları

Genel kullanım banyo duşları, hastane ve otel duş alanları, soyunma odaları duş alanları vb.

### Özel Üretim

Iızgara modeli olarak isteğinize göre altın, bronz gibi renkler de üretilmektedir.

### Uyarı

Yüksek yoğunluklu temizlik malzemelerinin uzun süreli kullanımı tavsiye edilmez.



KARE

ENDEKS

**LINE 15x15**



- Plastik gövde
- Paslanmaz ızgara
- Sulu koku tutucu
- Klepeli

Ürün Kodu	Kısa Kod	Çıkış	Ölçü	Fiyat
<b>YAN ÇIKIŞ</b>				
3012.0Y032K.015.1	13882	Ø 32	15x15 cm	80
3012.0Y040K.015.1	13888	Ø 40	15x15 cm	60
3012.0Y050K.015.1	13896	Ø 50	15x15 cm	60
3012.0Y070K.015.1	13903	Ø 70	15x15 cm	50
<b>ALT ÇIKIŞ</b>				
3012.0A040K.015.1	13911	Ø 40	15x15 cm	60
3012.0A050K.015.1	13926	Ø 50	15x15 cm	60
3012.0A070K.015.1	13933	Ø 70	15x15 cm	60

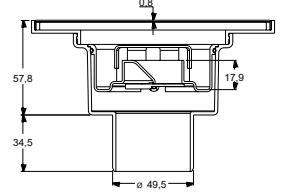
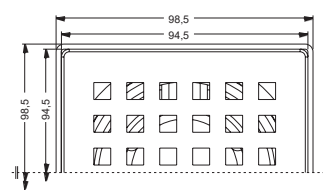
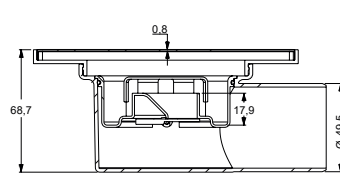
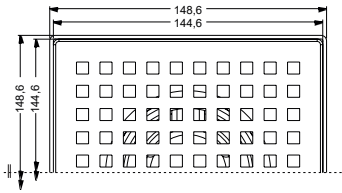

**Detaylar**

DN 50 Yan ve Alt çıkış – Pvc boru bağlantılarına uyumludur. Akış hızı 32 lt/dk'dır. Iızgarası 304 kalite paslanmaz çeliktir.

**Avantajlar**

304 kalite paslanmaz çelik ızgarası sayesinde şık ve kaliteli bir görünüme sahiptir. Duvar dibi uygulamalarda rahatlıkla uygulanabilir. Su tutuculu koku önleyici sayesinde tesisattan gelecek kötü kokuları önler. Yükseltme ayakları sayesinde şapın yüksekliğine göre ayarlama olanağı sağlar. Organik ve inorganik kimyasallara yüksek dayanım. çoğu asidik ve tuzlu su oksidasyonuna dayanıklıdır.

**Kullanım Alanları**

Genel kullanım banyo duşları, hastane ve otel duş alanları, soyunma odaları duş alanları vb.

**Özel Üretim**

Iızgara modeli olarak isteđinize göre altın, bronz gibi renkler de üretilmektedir.

**Uyarı**

Yüksek yoğunluklu temizlik malzemelerinin uzun süreli kullanımı tavsiye edilmez.



KARE



ENDEKS

## LEGAL 10x10

Ürün Kodu	Kısa Kod	Çıkış	Ölçü	Fiyat
<b>YAN ÇIKIŞ</b>				
3013.0Y032K.010.1	13940	Ø 32	10x10 cm	160
3013.0Y040K.010.1	13950	Ø 40	10x10 cm	100
3013.0Y050K.010.1	13960	Ø 50	10x10 cm	100
3013.0Y070K.010.1	13969	Ø 70	10x10 cm	80
<b>ALT ÇIKIŞ</b>				
3013.0A040K.010.1	13976	Ø 40	10x10 cm	140
3013.0A050K.010.1	13990	Ø 50	10x10 cm	140
3013.0A070K.010.1	13998	Ø 70	10x10 cm	140
<b>ELİTE LEGAL</b>				
3013.0Y032K.010.B	28911	Ø 32	10x10 cm	40
3013.0Y050K.010.B	28912	Ø 50	10x10 cm	40



- Plastik gövde
- Paslanmaz ızgara
- Sulu koku tutucu
- Klepeli

## LEGAL 15x15

Ürün Kodu	Kısa Kod	Çıkış	Ölçü	Fiyat
<b>YAN ÇIKIŞ</b>				
3013.0Y032K.015.1	13949	Ø 32	15x15 cm	80
3013.0Y040K.015.1	13968	Ø 40	15x15 cm	60
3013.0Y050K.015.1	13977	Ø 50	15x15 cm	60
3013.0Y070K.015.1	13981	Ø 70	15x15 cm	50
<b>ALT ÇIKIŞ</b>				
3013.0A040K.015.1	13989	Ø 40	15x15 cm	60
3013.0A050K.015.1	13996	Ø 50	15x15 cm	60
3013.0A070K.015.1	14006	Ø 70	15x15 cm	60



- Plastik gövde
- Paslanmaz ızgara
- Sulu koku tutucu
- Klepeli

### Detaylar

DN 50 Yan ve Alt çıkış – Pvc boru bağlantılarına uyumludur. Akış hızı 32 lt/dk'dır. Iızgarası 304 kalite paslanmaz çeliktir.

### Avantajlar

304 kalite paslanmaz çelik ızgarası sayesinde şık ve kaliteli bir görünüme sahiptir. Duvar dibi uygulamalarda rahatlıkla uygulanabilir. Su tutuculu koku önleyici sayesinde tesisattan gelecek kötü kokuları önler. Yükseltme ayakları sayesinde şapın yüksekliğine göre ayarlama olanağı sağlar. Organik ve inorganik kimyasallara yüksek dayanım. çoğu asidik ve tuzlu su oksidasyonuna dayanıklıdır.

### Kullanım Alanları

Genel kullanım banyo duşları, hastane ve otel duş alanları, soyunma odaları duş alanları vb.

### Özel Üretim

Iızgara modeli olarak isteğinize göre altın, bronz gibi renkler de üretilmektedir.

### Uyarı

Yüksek yoğunluklu temizlik malzemelerinin uzun süreli kullanımı tavsiye edilmez.

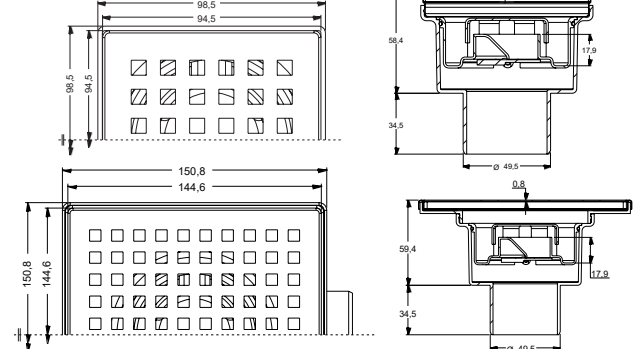
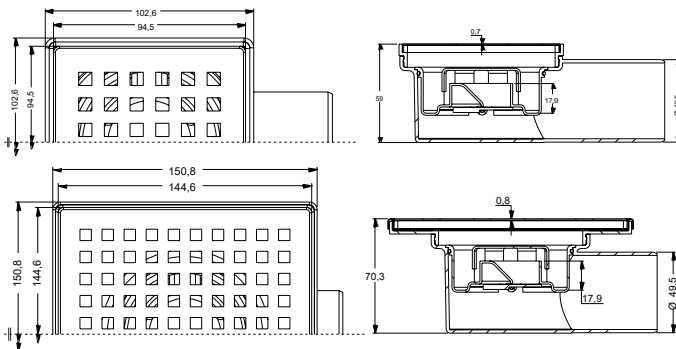

KARE



ENDEKS



- Plastik gövde
- Paslanmaz ızgara

**KUCA**

Ürün Kodu	Kısa Kod	Çıkış	Ölçü	Fiyat
<b>ALT ÇIKIŞ</b>				
5710.0A050K.010.1	13939	Ø 50	10x10 cm	61.00
5710.0A070K.010.1	13941	Ø 70	10x10 cm	62.40

**SCALA 10x10**

Ürün Kodu	Kısa Kod	Çıkış	Ölçü	Fiyat
<b>YAN ÇIKIŞ</b>				
3014.0Y032K.010.9	14005	Ø 32	10x10 cm	66.00
3014.0Y050K.010.9	14011	Ø 50	10x10 cm	66.70
<b>ALT ÇIKIŞ</b>				
3014.0A050K.010.9	14013	Ø 50	10x10 cm	66.70

- Plastik gövde
- Paslanmaz ızgara ve çerçeve
- Bariyerli koku tutucu

**SCALA 15x15**

Ürün Kodu	Kısa Kod	Çıkış	Ölçü	Fiyat
<b>YAN ÇIKIŞ</b>				
3014.0Y032K.015.9	14014	Ø 32	15x15 cm	100.00
3014.0Y050K.015.9	14015	Ø 50	15x15 cm	100.70
<b>ALT ÇIKIŞ</b>				
3014.0A050K.015.9	14017	Ø 50	15x15 cm	101.40

- Plastik gövde
- Paslanmaz ızgara
- Sulu klepeli koku tutucu

**KÖŞE BALKON**

Ürün Kodu	Kısa Kod	Çıkış	Fiyat
<b>Ø70</b>			
6001.0A070.13.0	13942	Ø 70	56.70
<b>Ø100</b>			
6002.0A100.16.0	13945	Ø 100	70.00

- Plastik gövde



## MIDI 10X10

Ürün Kodu	Kısa Kod	Çıkış	Ölçü		Fiyat
<b>YAN ÇIKIŞ</b>					
5001.0Y032.010.1	14010	Ø 32	10x10 cm	80	66.40
5001.0Y040.010.1	14018	Ø 40	10x10 cm	60	69.70
5001.0Y050.010.1	14022	Ø 50	10x10 cm	60	69.40
5001.0Y070.010.1	14025	Ø 70	10x10 cm	50	82.70
<b>ALT ÇIKIŞ</b>					
5001.0A040.010.1	14032	Ø 40	10x10 cm	50	74.70
5001.0A050.010.1	14035	Ø 50	10x10 cm	50	71.40
5001.0A070.010.1	14039	Ø 70	10x10 cm	50	74.70



- Plastik gövde
- Paslanmaz ızgara
- Sulu koku tutucu
- Klepeli

## STD. 10x10

Ürün Kodu	Kısa Kod	Çıkış	Ölçü		Fiyat
<b>YAN ÇIKIŞ</b>					
5002.0Y032.010.1	14019	Ø 32	10x10 cm	60	90.70
5002.0Y040.010.1	14041	Ø 40	10x10 cm	50	93.40
5002.0Y050.010.1	14046	Ø 50	10x10 cm	50	91.40
5002.0Y070.010.1	14050	Ø 70	10x10 cm	30	103.70
5002.0Y100.010.1	14052	Ø 100	10x10 cm	20	119.00
<b>ALT ÇIKIŞ</b>					
5002.0A040.010.1	14062	Ø 40	10x10 cm	50	90.00
5002.0A050.010.1	14067	Ø 50	10x10 cm	50	90.00
5002.0A070.010.1	14078	Ø 70	10x10 cm	50	90.40
5002.0A100.010.1	14083	Ø 100	10x10 cm	30	96.40



- Plastik gövde
- Paslanmaz ızgara
- Sulu koku tutucu
- Klepeli

## STD. FİLELİ 10X10

Ürün Kodu	Kısa Kod	Çıkış	Ölçü		Fiyat
<b>YAN ÇIKIŞ</b>					
5002.FY032.010.1	14059	Ø 32	10x10 cm	30	97.70
5002.FY040.010.1	14055	Ø 40	10x10 cm	20	100.40
5002.FY050.010.1	14061	Ø 50	10x10 cm	20	98.00
5002.FY070.010.1	14068	Ø 70	10x10 cm	20	110.00
5002.FY100.010.1	14073	Ø 100	10x10 cm	10	118.00
<b>ALT ÇIKIŞ</b>					
5002.FA040.010.1	14077	Ø 40	10x10 cm	20	96.70
5002.FA050.010.1	14084	Ø 50	10x10 cm	20	97.00
5002.FA070.010.1	14088	Ø 70	10x10 cm	20	97.40
5002.FA100.010.1	14093	Ø 100	10x10 cm	10	103.00

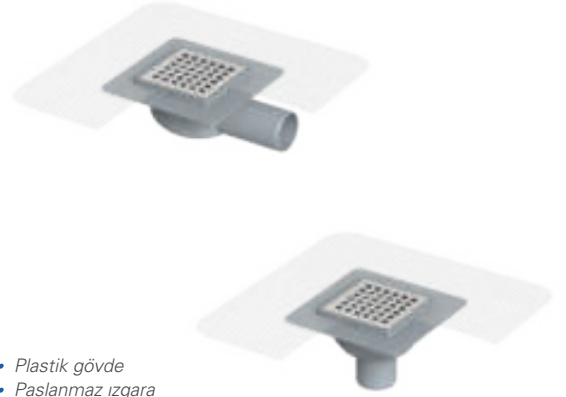

- Plastik gövde
- Paslanmaz ızgara
- Fileli
- Sulu klepeli koku tutucu

## STD. TEKSTİL MEMBRANLI 10X10

Ürün Kodu	Kısa Kod	Çıkış	Ölçü		Fiyat
<b>YAN ÇIKIŞ</b>					
5002.TY032.010.1	14091	Ø 32	10x10 cm	30	114.40
5002.TY040.010.1	14103	Ø 40	10x10 cm	20	117.00
5002.TY050.010.1	14107	Ø 50	10x10 cm	20	114.70
5002.TY070.010.1	14112	Ø 70	10x10 cm	20	127.00
5002.TY100.010.1	14120	Ø 100	10x10 cm	10	142.00
<b>ALT ÇIKIŞ</b>					
5002.TA040.010.1	14124	Ø 40	10x10 cm	20	113.40
5002.TA050.010.1	14128	Ø 50	10x10 cm	20	113.70
5002.TA070.010.1	14132	Ø 70	10x10 cm	20	114.00
5002.TA100.010.1	14136	Ø 100	10x10 cm	10	119.70

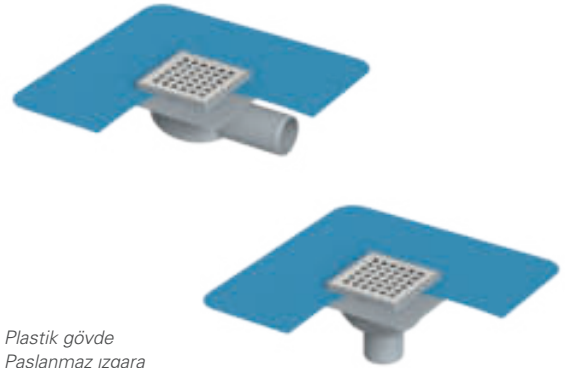

- Plastik gövde
- Paslanmaz ızgara
- Tekstil membranlı
- Sulu klepeli koku tutucu

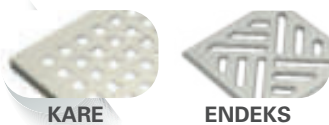

KARE

ENDEKS

**PREMIUM 10x10**



Ürün Kodu	Kısa Kod	Çıkış	Ölçü		Fiyat
<b>YAN ÇIKIŞ</b>					
3045.0Y032K.010.1	14096	Ø 32	10x10 cm	24	233.40
3045.0Y050K.010.1	14097	Ø 50	10x10 cm	24	250.00
<b>ALT ÇIKIŞ</b>					
3045.0A050K.010.1	14099	Ø 50	10x10 cm	24	233.40

- Paslanmaz gövde
- Paslanmaz ızgara
- Paslanmaz koku tutucu

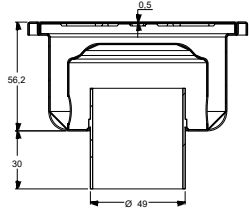
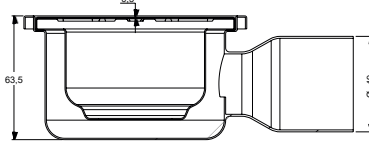
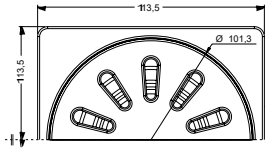

**PREMIUM 15X15**



Ürün Kodu	Kısa Kod	Çıkış	Ölçü		Fiyat
<b>YAN ÇIKIŞ</b>					
3045.0Y032K.015.1	14100	Ø 32	15x15 cm	24	256.70
3045.0Y050K.015.1	14102	Ø 50	15x15 cm	24	273.40
3045.0Y070K.015.1	14104	Ø 70	15x15 cm	24	296.70
<b>ALT ÇIKIŞ</b>					
3045.0A050K.015.1	14108	Ø 50	15x15 cm	24	260.00
3045.0A070K.015.1	14111	Ø 70	15x15 cm	24	293.40

- Paslanmaz gövde
- Paslanmaz ızgara
- Paslanmaz koku tutucu

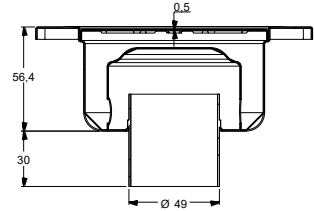
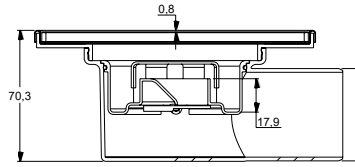
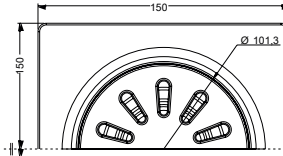

**PREMIUM 20x20**



Ürün Kodu	Kısa Kod	Çıkış	Ölçü		Fiyat
<b>YAN ÇIKIŞ</b>					
3045.0Y070K.020.1	14115	Ø 70	20x20 cm	12	1186.70
3045.0Y100K.020.1	14116	Ø 100	20x20 cm	12	1276.70
<b>ALT ÇIKIŞ</b>					
3045.0A070K.020.1	14117	Ø 70	20x20 cm	12	1216.70
3045.0A100K.020.1	14119	Ø 100	20x20 cm	12	1310.00

- Paslanmaz gövde
- Paslanmaz ızgara
- Paslanmaz koku tutucu

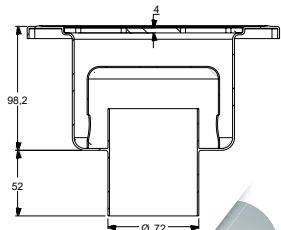
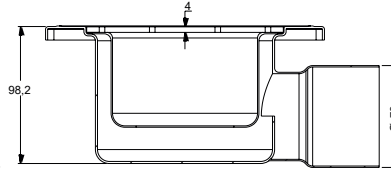
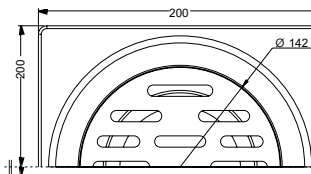

## SIFON ÜST GÖVDE

## LINE

Ürün Kodu	Kısa Kod	Çıkış	Ölçü		Fiyat
<b>10X10</b>					
5101.0A100.10.1	14198	Ø 100	10x10 cm	150	76.70
<b>15X15</b>					
5107.0A100.15.1	14200	Ø 100	15x15 cm	80	120.00

- Plastik gövde
- Paslanmaz ızgara
- Sulu klepelî koku tutucu



## LEGAL

Ürün Kodu	Kısa Kod	Çıkış	Ölçü		Fiyat
<b>10X10</b>					
5102.0A100.10.1	14204	Ø 100	10x10 cm	150	103.40
<b>15X15</b>					
5108.0A100.15.1	14206	Ø 100	15x15 cm	80	163.40

- Plastik gövde
- Paslanmaz ızgara
- Sulu klepelî koku tutucu



## PREMIUM

Ürün Kodu	Kısa Kod	Çıkış	Ölçü		Fiyat
<b>10X10</b>					
5105.0A100.10.0	14207	Ø 100	10x10 cm	120	116.70
<b>15X15</b>					
5111.0A100.15.0	14209	Ø 100	15x15 cm	80	143.40

- Plastik gövde
- Paslanmaz ızgara
- Sulu klepelî koku tutucu



## RING

Ürün Kodu	Kısa Kod	Çıkış		Fiyat
<b>RING</b>				
1207001100100	14208	Ø 100	150	23.40
<b>IZGARALI RING</b>				
5112.0A100.00.1	14210	Ø 100	150	76.70

- Yükseltme ara parçası



- Plastik gövde
- Paslanmaz ızgara
- Sulu klepelî koku tutucu



KARE



ENDEKS



**SCALA 10X10**

Ürün Kodu	Kısa Kod	Çıkış	Ölçü	Fiyat
<b>ALT ÇIKIŞ</b>				
5103.0A100.10.0	14199	Ø 100	10x10 cm	120
<ul style="list-style-type: none"> <li>Plastik gövde</li> <li>Sulu klepeli koku tutucu</li> </ul>				

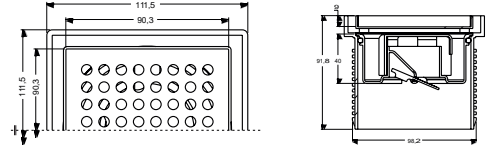

**SCALA 15X15**

Ürün Kodu	Kısa Kod	Çıkış	Ölçü	Fiyat
<b>ALT ÇIKIŞ</b>				
5109.0A100.15.0	14202	Ø 100	15x15 cm	80
<ul style="list-style-type: none"> <li>Plastik gövde</li> <li>Sulu klepeli koku tutucu</li> </ul>				

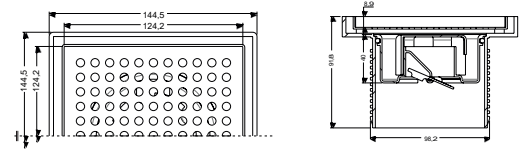

**ELİT 10x10**

Ürün Kodu	Kısa Kod	Çıkış	Ölçü	Fiyat
<b>ALT ÇIKIŞ</b>				
5104.0A100.10.0	14203	Ø 100	10x10 cm	120
<ul style="list-style-type: none"> <li>Plastik gövde</li> <li>Paslanmaz ızgara</li> <li>Sulu klepeli koku tutucu</li> </ul>				

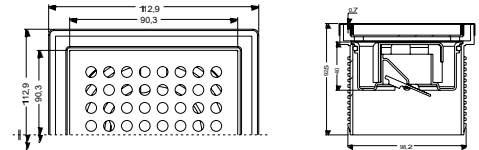

**ELİT 15x15**

Ürün Kodu	Kısa Kod	Çıkış	Ölçü	Fiyat
<b>ALT ÇIKIŞ</b>				
5110.0A100.15.0	14205	Ø 100	15x15 cm	80
<ul style="list-style-type: none"> <li>Plastik gövde</li> <li>Paslanmaz ızgara</li> <li>Sulu klepeli koku tutucu</li> </ul>				

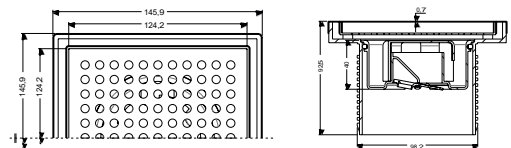

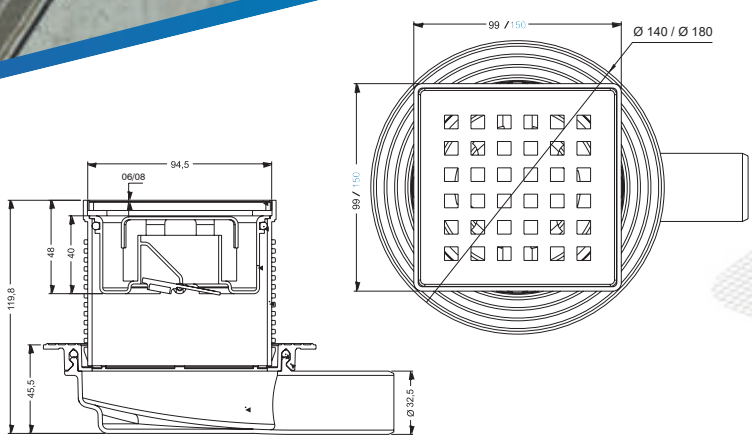
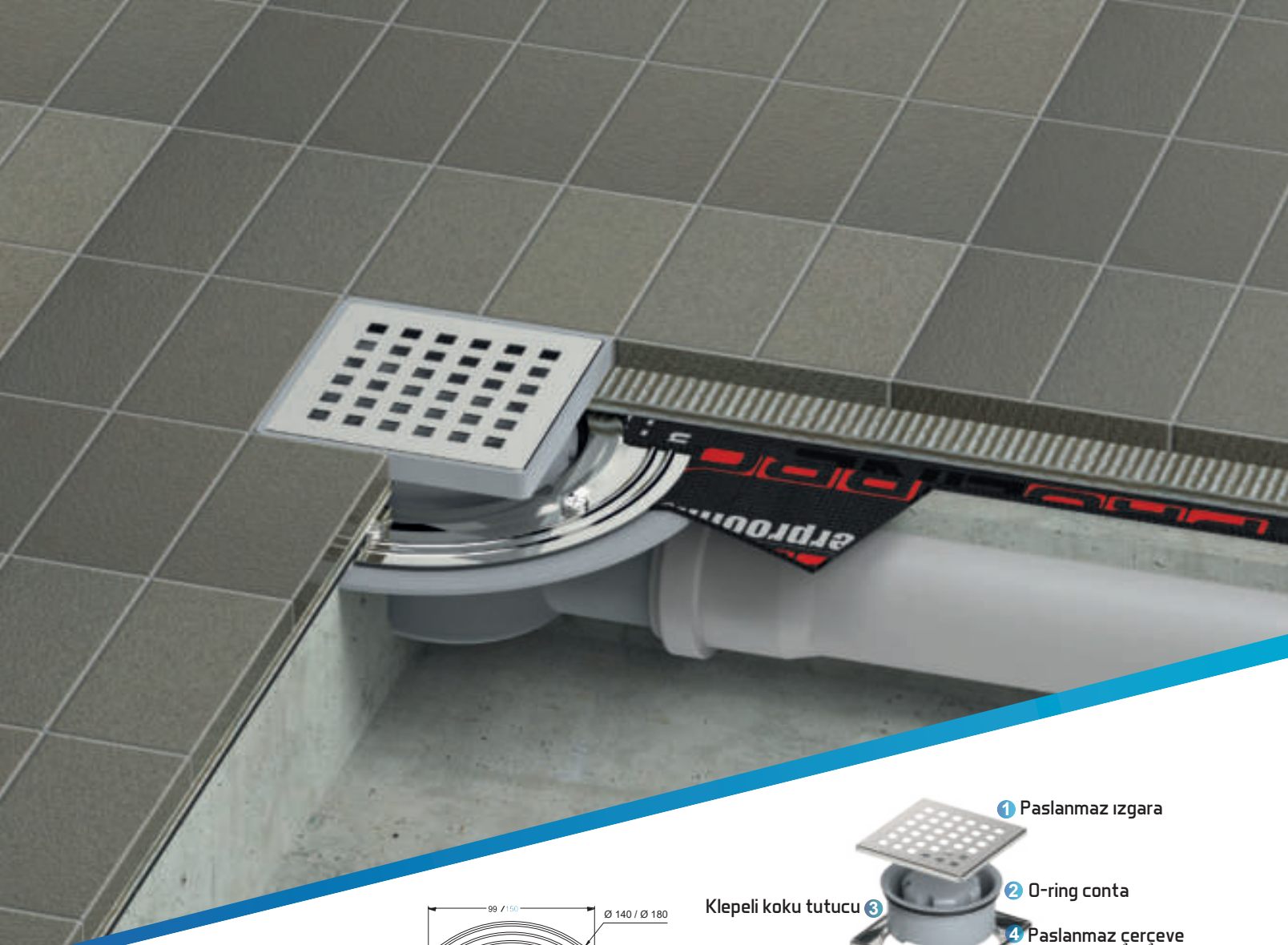

Ø 32 YAN ÇIKIŞ

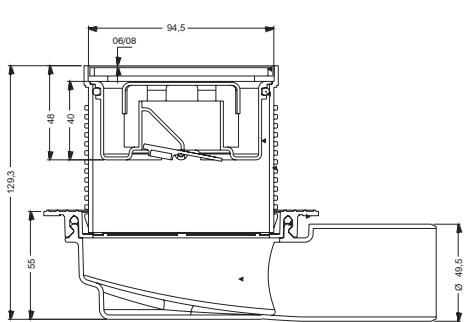

Ø 50 YAN ÇIKIŞ

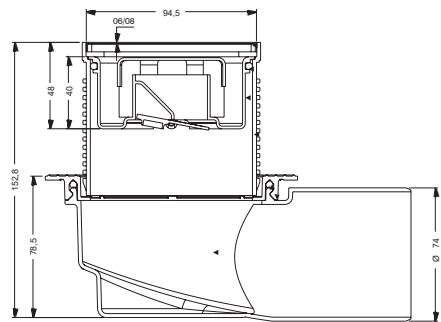

Ø 70 YAN ÇIKIŞ

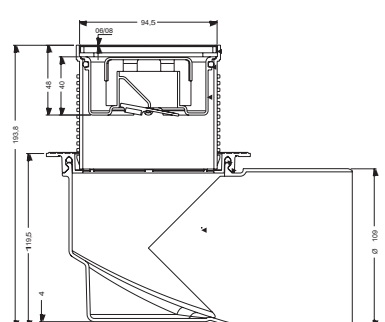

Ø 100 YAN ÇIKIŞ

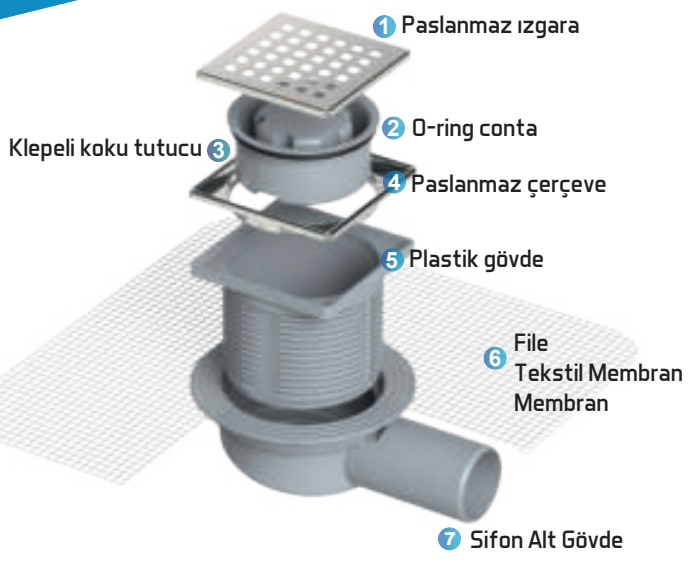

**140MM DUVAR DİBİ**



Ürün Kodu	Kısa Kod	Çıkış	Yükseklik	Fiyat
<b>YAN ÇIKIŞ</b>				
5014.0Y032.00.0	14212	Ø 32	46 mm	36.70
5014.0Y040.00.0	14213	Ø 40	55 mm	40.00
5014.0Y050.00.0	14215	Ø 50	55 mm	40.00
5014.0Y070.00.0	14224	Ø 70	79 mm	46.70
5014.0Y100.00.0	14225	Ø 100	115 mm	56.70
<b>ALT ÇIKIŞ</b>				
5014.0A040.00.0	14226	Ø 40	96 mm	36.70
5014.0A050.00.0	14227	Ø 50	96 mm	33.40
5014.0A070.00.0	14228	Ø 70	96 mm	36.70
5014.0A100.00.0	14229	Ø 100	96 mm	40.00

- Sifon alt gövde
- 140 mm flanşlı

**180MM**



Ürün Kodu	Kısa Kod	Çıkış	Yükseklik	Fiyat
<b>YAN ÇIKIŞ</b>				
5018.0Y032.00.0	14211	Ø 32	46 mm	43.40
5018.0Y040.00.0	14214	Ø 40	55 mm	43.40
5018.0Y050.00.0	14216	Ø 50	55 mm	43.40
5018.0Y070.00.0	14217	Ø 70	79 mm	50.00
5018.0Y100.00.0	14218	Ø 100	115 mm	70.00
<b>ALT ÇIKIŞ</b>				
5018.0A040.00.0	14219	Ø 40	96 mm	40.00
5018.0A050.00.0	14220	Ø 50	96 mm	40.00
5018.0A070.00.0	14221	Ø 70	96 mm	43.40
5018.0A100.00.0	14222	Ø 100	96 mm	43.40

- Sifon alt gövde
- 180 mm flanşlı

**210MM**



Ürün Kodu	Kısa Kod	Çıkış	Yükseklik	Fiyat
<b>YAN ÇIKIŞ</b>				
5021.0Y032.00.0	14231	Ø 32	46 mm	50.00
5021.0Y040.00.0	14232	Ø 40	55 mm	50.00
5021.0Y050.00.0	14233	Ø 50	55 mm	50.00
5021.0Y070.00.0	14234	Ø 70	79 mm	56.70
5021.0Y100.00.0	14236	Ø 100	115 mm	73.40
<b>ALT ÇIKIŞ</b>				
5021.0A040.00.0	14237	Ø 40	96 mm	46.70
5021.0A050.00.0	14239	Ø 50	96 mm	46.70
5021.0A070.00.0	14241	Ø 70	96 mm	46.70
5021.0A100.00.0	14243	Ø 100	96 mm	50.00

- Sifon alt gövde
- 210 mm flanşlı

## SIFON ALT GÖVDE

## 140 MM FİLELİ

Ürün Kodu	Kısa Kod	Çıkış	Yükseklik	Fiyat	
<b>YAN ÇIKIŞ</b>					
5014.FY032.00.0	14230	Ø 32	46 mm	125	50.00
5014.FY040.00.0	14235	Ø 40	55 mm	125	50.00
5014.FY050.00.0	14238	Ø 50	55 mm	100	50.00
5014.FY070.00.0	14242	Ø 70	79 mm	75	56.70
5014.FY100.00.0	14244	Ø 100	115 mm	75	66.70
<b>ALT ÇIKIŞ</b>					
5014.FA040.00.0	14246	Ø 40	96 mm	100	46.70
5014.FA050.00.0	14247	Ø 50	96 mm	100	46.70
5014.FA070.00.0	14248	Ø 70	96 mm	75	50.00
5014.FA100.00.0	14249	Ø 100	96 mm	75	50.00

- Sifon alt gövde
- 140 mm fileli flanşlı



## 180MM FİLELİ

Ürün Kodu	Kısa Kod	Çıkış	Yükseklik	Fiyat	
<b>YAN ÇIKIŞ</b>					
5018.FY032.00.0	14245	Ø 32	46 mm	100	50.00
5018.FY040.00.0	14250	Ø 40	55 mm	100	53.40
5018.FY050.00.0	14251	Ø 50	55 mm	100	53.40
5018.FY070.00.0	14253	Ø 70	79 mm	75	60.00
5018.FY100.00.0	14255	Ø 100	115 mm	72	70.00
<b>ALT ÇIKIŞ</b>					
5018.FA040.00.0	14262	Ø 40	96 mm	100	50.00
5018.FA050.00.0	14265	Ø 50	96 mm	90	50.00
5018.FA070.00.0	14266	Ø 70	96 mm	85	50.00
5018.FA100.00.0	14267	Ø 100	96 mm	72	53.40

- Sifon alt gövde
- 180 mm fileli flanşlı



## 140MM T. MEMBRANLI

Ürün Kodu	Kısa Kod	Çıkış	Yükseklik	Fiyat	
<b>YAN ÇIKIŞ</b>					
5014.TY032.00.0	14252	Ø 32	46 mm	125	56.70
5014.TY040.00.0	14254	Ø 40	55 mm	125	60.00
5014.TY050.00.0	14256	Ø 50	55 mm	100	60.00
5014.TY070.00.0	14257	Ø 70	79 mm	75	66.70
5014.TY100.00.0	14258	Ø 100	115 mm	75	73.40
<b>ALT ÇIKIŞ</b>					
5014.TA040.00.0	14259	Ø 40	96 mm	100	56.70
5014.TA050.00.0	14260	Ø 50	96 mm	100	56.70
5014.TA070.00.0	14261	Ø 70	96 mm	75	60.00
5014.TA100.00.0	14263	Ø 100	96 mm	75	60.00

- Sifon alt gövde
- 140 mm Tekstil Membranlı flanşlı

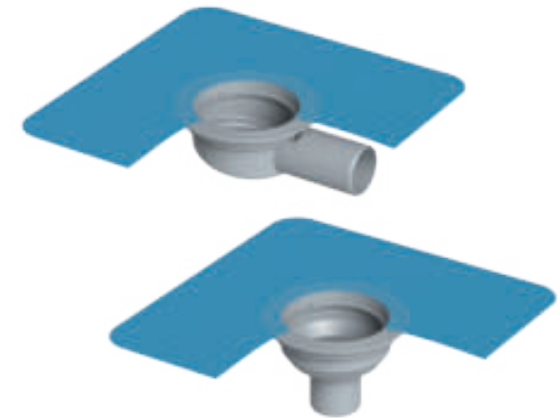

**180 MM T.MEMBRANLI**

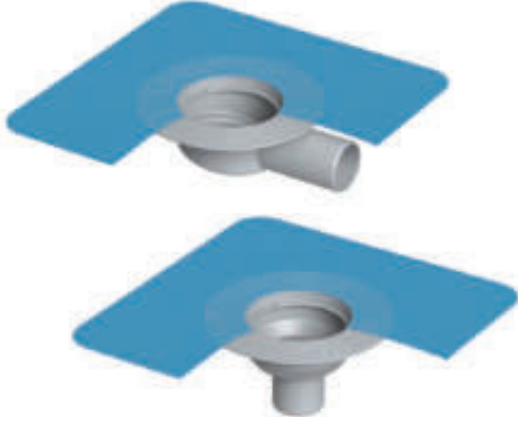

Ürün Kodu	Kısa Kod	Çıkış	Yükseklik	Fiyat	
<b>YAN ÇIKIŞ</b>					
5018.TY032.00.0	14264	Ø 32	46 mm	100	60.00
5018.TY040.00.0	14268	Ø 40	55 mm	100	63.40
5018.TY050.00.0	14270	Ø 50	55 mm	90	63.40
5018.TY070.00.0	14271	Ø 70	79 mm	75	66.70
5018.TY100.00.0	14272	Ø 100	115 mm	50	80.00
<b>ALT ÇIKIŞ</b>					
5018.TA040.00.0	14273	Ø 40	96 mm	85	60.00
5018.TA050.00.0	14276	Ø 50	96 mm	85	60.00
5018.TA070.00.0	14278	Ø 70	96 mm	75	60.00
5018.TA100.00.0	14280	Ø 100	96 mm	75	60.00

- Sifon alt gövde
- 180 mm tekstil membranlı flanşlı

**210 MM MEMBRANLI**

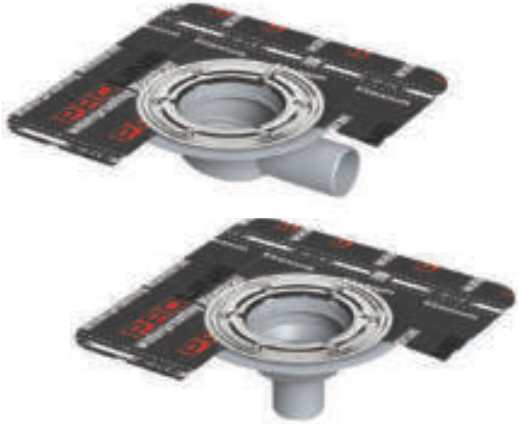

Ürün Kodu	Kısa Kod	Çıkış	Yükseklik	Fiyat	
<b>YAN ÇIKIŞ</b>					
5021.MY032.00.0	14269	Ø 32	50 mm	35	130.00
5021.MY040.00.0	14274	Ø 40	59 mm	35	133.40
5021.MY050.00.0	14277	Ø 50	59 mm	35	133.40
5021.MY070.00.0	14279	Ø 70	84 mm	30	140.00
5021.MY100.00.0	14281	Ø 100	119 mm	30	150.00
<b>ALT ÇIKIŞ</b>					
5021.MA040.00.0	14283	Ø 40	100 mm	30	130.00
5021.MA050.00.0	14284	Ø 50	100 mm	30	130.00
5021.MA070.00.0	14285	Ø 70	100 mm	30	130.00
5021.MA100.00.0	14287	Ø 100	100 mm	30	133.40

- Paslanmaz gövde
- Paslanmaz flanş takımı
- Bitüm membranlı

**ALT ÇIKIŞ ÖLÇÜLERİ**

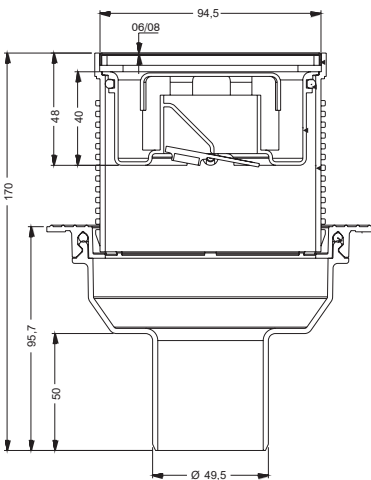

**Ø 50 ALT ÇIKIŞ**

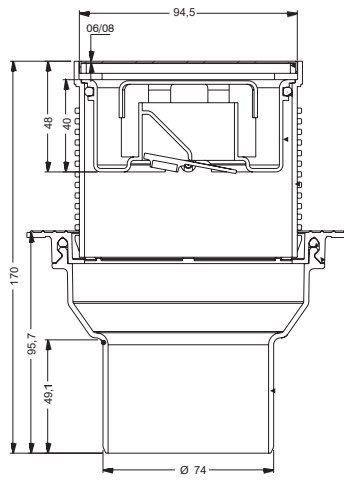

**Ø 70 ALT ÇIKIŞ**

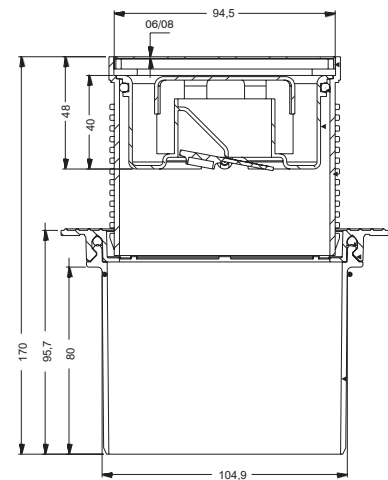

**Ø 100 ALT ÇIKIŞ**



### 140 MM 10x10 DUVAR DİBİ

Ürün Kodu	Kısa Kod	Çıkış	Ölçü		Fiyat
<b>YAN ÇIKIŞ</b>					
5054.0Y032.10.1	14282	Ø 32	10x10 cm	50	113.40
5054.0Y040.10.1	14286	Ø 40	10x10 cm	50	113.40
5054.0Y050.10.1	14289	Ø 50	10x10 cm	50	113.40
5054.0Y070.10.1	14290	Ø 70	10x10 cm	50	120.00
5054.0Y100.10.1	14291	Ø 100	10x10 cm	50	126.70
<b>ALT ÇIKIŞ</b>					
5054.0A040.10.1	14292	Ø 40	10x10 cm	50	110.00
5054.0A050.10.1	14293	Ø 50	10x10 cm	50	110.00
5054.0A070.10.1	14294	Ø 70	10x10 cm	50	110.00
5054.0A100.10.1	14295	Ø 100	10x10 cm	50	113.40

- Plastik gövde
- Paslanmaz ızgara
- Sulu klepelili koku tutucu
- 140 mm flanşlı



### 180MM 10X10

Ürün Kodu	Kısa Kod	Çıkış	Ölçü		Fiyat
<b>YAN ÇIKIŞ</b>					
5058.0Y032.10.1	14288	Ø 32	10x10 cm	50	116.70
5058.0Y040.10.1	14296	Ø 40	10x10 cm	50	116.70
5058.0Y050.10.1	14299	Ø 50	10x10 cm	50	116.70
5058.0Y070.10.1	14302	Ø 70	10x10 cm	50	123.40
5058.0Y100.10.1	14303	Ø 100	10x10 cm	50	130.00
<b>ALT ÇIKIŞ</b>					
5058.0A040.10.1	14305	Ø 40	10x10 cm	50	113.40
5058.0A050.10.1	14307	Ø 50	10x10 cm	50	113.40
5058.0A070.10.1	14309	Ø 70	10x10 cm	50	113.40
5058.0A100.10.1	14311	Ø 100	10x10 cm	50	116.70

- Plastik gövde
- Paslanmaz ızgara
- Sulu klepelili koku tutucu
- 180 mm flanşlı



### 180MM 15X15

Ürün Kodu	Kısa Kod	Çıkış	Ölçü		Fiyat
<b>YAN ÇIKIŞ</b>					
5058.0Y032.15.1	14298	Ø 32	15x15cm	50	170.00
5058.0Y040.15.1	14300	Ø 40	15x15cm	50	173.40
5058.0Y050.15.1	14301	Ø 50	15x15cm	50	173.40
5058.0Y070.15.1	14304	Ø 70	15x15cm	50	176.70
5058.0Y100.15.1	14306	Ø 100	15x15cm	50	183.40
<b>ALT ÇIKIŞ</b>					
5058.0A040.15.1	14308	Ø 40	15x15cm	50	170.00
5058.0A050.15.1	14310	Ø 50	15x15cm	50	170.00
5058.0A070.15.1	14312	Ø 70	15x15cm	50	170.00
5058.0A100.15.1	14314	Ø 100	15x15cm	50	170.00

- Plastik gövde
- Paslanmaz ızgara
- Sulu klepelili koku tutucu
- 180 mm flanşlı



**140 MM 10x10 FİLELİ**



Ürün Kodu	Kısa Kod	Çıkış	Ölçü	Fiyat
<b>YAN ÇIKIŞ</b>				
5054.FY032.10.1	14313	Ø 32	10x10 cm	123.40
5054.FY040.10.1	14319	Ø 40	10x10 cm	123.40
5054.FY050.10.1	14321	Ø 50	10x10 cm	123.40
5054.FY070.10.1	14322	Ø 70	10x10 cm	130.00
5054.FY100.10.1	14323	Ø 100	10x10 cm	136.70
<b>ALT ÇIKIŞ</b>				
5054.FA040.10.1	14324	Ø 40	10x10 cm	120.00
5054.FA050.10.1	14325	Ø 50	10x10 cm	120.00
5054.FA070.10.1	14326	Ø 70	10x10 cm	120.00
5054.FA100.10.1	14327	Ø 100	10x10 cm	120.00

- Plastik gövde
- Paslanmaz ızgara
- Sulu klepelî koku tutucu
- 140 mm fileli flanşlı

**180 MM 10x10 FİLELİ**



Ürün Kodu	Kısa Kod	Çıkış	Ölçü	Fiyat
<b>YAN ÇIKIŞ</b>				
5058.FY032.10.1	14315	Ø 32	10x10 cm	123.40
5058.FY040.10.1	14316	Ø 40	10x10 cm	126.70
5058.FY050.10.1	14317	Ø 50	10x10 cm	126.70
5058.FY070.10.1	14318	Ø 70	10x10 cm	130.00
5058.FY100.10.1	14320	Ø 100	10x10 cm	140.00
<b>ALT ÇIKIŞ</b>				
5058.FA040.10.1	14328	Ø 40	10x10 cm	123.40
5058.FA050.10.1	14330	Ø 50	10x10 cm	123.40
5058.FA070.10.1	14331	Ø 70	10x10 cm	123.40
5058.FA100.10.1	14332	Ø 100	10x10 cm	123.40

- Plastik gövde
- Paslanmaz ızgara
- Sulu klepelî koku tutucu
- 180 mm fileli flanşlı

**180 MM 15x15 FİLELİ**



Ürün Kodu	Kısa Kod	Çıkış	Ölçü	Fiyat
<b>YAN ÇIKIŞ</b>				
5058.FY032.15.1	14333	Ø 32	15x15cm	180.00
5058.FY040.15.1	14334	Ø 40	15x15cm	180.00
5058.FY050.15.1	14335	Ø 50	15x15cm	180.00
5058.FY070.15.1	14336	Ø 70	15x15cm	183.40
5058.FY100.15.1	14337	Ø 100	15x15cm	193.40
<b>ALT ÇIKIŞ</b>				
5058.FA040.15.1	14338	Ø 40	15x15cm	176.70
5058.FA050.15.1	14340	Ø 50	15x15cm	176.70
5058.FA070.15.1	14341	Ø 70	15x15cm	176.70
5058.FA100.15.1	14344	Ø 100	15x15cm	176.70

- Plastik gövde
- Paslanmaz ızgara
- Sulu klepelî koku tutucu
- 180 mm fileli flanşlı

# YALITIM UYUMLU SIFONLAR

**MAXIFLOW**  
Maksimum akış...

## 140 MM 10x10 T.MEMBRANLI

Ürün Kodu	Kısa Kod	Çıkış	Ölçü		Fiyat
<b>YAN ÇIKIŞ</b>					
5054.TY032.10.1	14342	Ø 32	10x10 cm	50	134.00
5054.TY040.10.1	14346	Ø 40	10x10 cm	50	135.40
5054.TY050.10.1	14349	Ø 50	10x10 cm	50	135.70
5054.TY070.10.1	14351	Ø 70	10x10 cm	50	140.00
5054.TY100.10.1	14353	Ø 100	10x10 cm	50	148.00
<b>ALT ÇIKIŞ</b>					
5054.TA040.10.1	14356	Ø 40	10x10 cm	50	132.00
5054.TA050.10.1	14357	Ø 50	10x10 cm	50	132.00
5054.TA070.10.1	14359	Ø 70	10x10 cm	50	132.40
5054.TA100.10.1	14361	Ø 100	10x10 cm	50	132.70

- Paslanmaz gövde
- Paslanmaz ızgara
- Sulu klepelili koku tutucu
- 140 mm tekstil membranlı flanşlı



## 180 MM 10x10 T.MEMBRANLI

Ürün Kodu	Kısa Kod	Çıkış	Ölçü		Fiyat
<b>YAN ÇIKIŞ</b>					
5058.TY032.10.1	14345	Ø 32	10x10 cm	50	136.70
5058.TY040.10.1	14348	Ø 40	10x10 cm	50	140.00
5058.TY050.10.1	14350	Ø 50	10x10 cm	50	140.00
5058.TY070.10.1	14352	Ø 70	10x10 cm	50	143.40
5058.TY100.10.1	14354	Ø 100	10x10 cm	50	150.00
<b>ALT ÇIKIŞ</b>					
5058.TA040.10.1	14355	Ø 40	10x10 cm	50	136.70
5058.TA050.10.1	14358	Ø 50	10x10 cm	50	136.70
5058.TA070.10.1	14360	Ø 70	10x10 cm	50	136.70
5058.TA100.10.1	14362	Ø 100	10x10 cm	50	136.70

- Paslanmaz gövde
- Paslanmaz ızgara
- Sulu klepelili koku tutucu
- 180 mm tekstil membranlı flanşlı



## 180 MM 15x15 T.MEMBRANLI

Ürün Kodu	Kısa Kod	Çıkış	Ölçü		Fiyat
<b>YAN ÇIKIŞ</b>					
5058.TY032.15.1	14364	Ø 32	15x15cm	50	190.00
5058.TY040.15.1	14365	Ø 40	15x15cm	50	193.40
5058.TY050.15.1	14366	Ø 50	15x15cm	50	193.40
5058.TY070.15.1	14367	Ø 70	15x15cm	50	196.70
5058.TY100.15.1	14368	Ø 100	15x15cm	50	206.70
<b>ALT ÇIKIŞ</b>					
5058.TA040.15.1	14369	Ø 40	15x15cm	50	190.00
5058.TA050.15.1	14370	Ø 50	15x15cm	50	190.00
5058.TA070.15.1	14371	Ø 70	15x15cm	50	190.00
5058.TA100.15.1	14372	Ø 100	15x15cm	50	190.00

- Paslanmaz gövde
- Paslanmaz ızgara
- Sulu klepelili koku tutucu
- 180 mm tekstil membranlı flanşlı

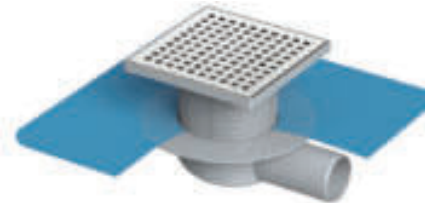

**210 MM 10x10 MEMBRANLI**



Ürün Kodu	Kısa Kod	Çıkış	Ölçü	Fiyat
<b>YAN ÇIKIŞ</b>				
5061.MY032.10.1	14363	Ø 32	10x10 cm	220.00
5061.MY040.10.1	14373	Ø 40	10x10 cm	220.00
5061.MY050.10.1	14374	Ø 50	10x10 cm	220.00
5061.MY070.10.1	14375	Ø 70	10x10 cm	223.40
5061.MY100.10.1	14377	Ø 100	10x10 cm	233.40
<b>ALT ÇIKIŞ</b>				
5061.MA040.10.1	14378	Ø 40	10x10 cm	216.70
5061.MA050.10.1	14379	Ø 50	10x10 cm	216.70
5061.MA070.10.1	14380	Ø 70	10x10 cm	216.70
5061.MA100.10.1	14385	Ø 100	10x10 cm	216.70

- Paslanmaz gövde
- Paslanmaz ızgara
- Sulu klepelı koku tutucu
- 210 mm bitüm membranlı

**210 MM 15x15 MEMBRANLI**



Ürün Kodu	Kısa Kod	Çıkış	Ölçü	Fiyat
<b>YAN ÇIKIŞ</b>				
5061.MY032.15.1	14376	Ø 32	15x15cm	263.40
5061.MY040.15.1	14381	Ø 40	15x15cm	263.40
5061.MY050.15.1	14382	Ø 50	15x15cm	263.40
5061.MY070.15.1	14383	Ø 70	15x15cm	270.00
5061.MY100.15.1	14384	Ø 100	15x15cm	276.70
<b>ALT ÇIKIŞ</b>				
5061.MA040.15.1	14386	Ø 40	15x15cm	260.00
5061.MA050.15.1	14388	Ø 50	15x15cm	260.00
5061.MA070.15.1	14390	Ø 70	15x15cm	260.00
5061.MA100.15.1	14392	Ø 100	15x15cm	263.40

- Paslanmaz gövde
- Paslanmaz ızgara
- Sulu klepelı koku tutucu
- 210 mm bitüm membranlı



## PARAPET

Ürün Kodu	Kısa Kod	Çap		Fiyat
<b>YAN ÇIKIŞ</b>				
8001.0Y070.00.0	14387	Ø 70	30	56.70
8002.0Y100.00.0	14389	Ø 100	25	70.00

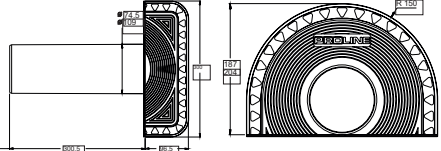

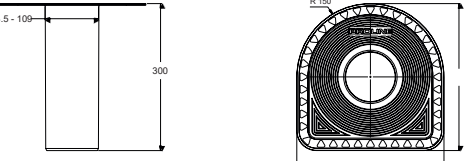

## DİK İNİŞ

Ürün Kodu	Kısa Kod	Çap		Fiyat
8001.0A070.00.0	14387	Ø 70	30	56.70
8002.0A100.00.0	14389	Ø 100	25	70.00





## ÇATI HAVALANDIRMA

Ürün Kodu	Kısa Kod	Çap		Fiyat
<b>ÇATI HAVALANDIRMA ŞAPKASI</b>				
8003.0D070.00.0	14394	Ø 70	150	20.70
8004.0D100.00.0	14396	Ø 100	90	23.00
<b>ÇATI HAVALANDIRMA SET</b>				
8005.0D070.00.0	28907	Ø 70	150	80.00
8006.0D100.00.0	28908	Ø 100	90	96.70



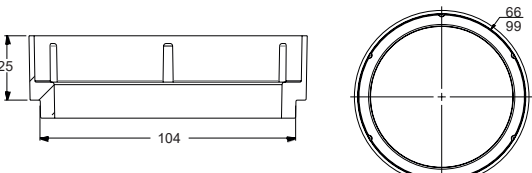

## PARAPET ARA BAĞLARI

Ürün Kodu	Kısa Kod	Çap		Fiyat
8201.0A070.10.0	14398	Ø 70	400	13.40
8202.0A100.10.0	14399	Ø 100	300	13.40



## YAPRAK TUTUCU

Ürün Kodu	Kısa Kod	Çıkış		Fiyat
9302.0D070.00.0	31308	Ø 50-70	400	20.00
9302.0D100.00.0	14395	Ø 70-100	175	23.40







- 8001- Ø 70 Parapet + 5014.0Y050.10.1 Sifon Takımı
- 8002- Ø 100 Parapet + 5014.0Y070.10.1 Sifon Takımı



- 8001- Ø 70 Parapet + 5018.0Y050.15.1 Sifon Takımı
- 8002- Ø 100 Parapet + 5018.0Y070.15.1 Sifon Takımı

**PARAPET İKİZ GİDER**

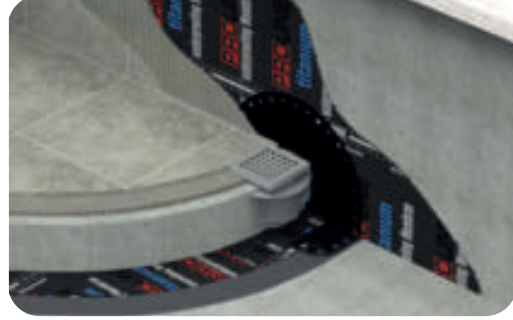
Ürün Kodu	Kısa Kod	Çap	Ölçü		Fiyat
<b>10x10</b>					
8101.0Y070.10.1	14400	Ø 70	10x10 cm	1	220.00
8101.0Y100.10.1	14402	Ø 100	10x10 cm	1	233.40
<b>15x15</b>					
8101.0Y070.15.1	14403	Ø 70	15x15 cm	1	266.70
8101.0Y100.15.1	14405	Ø 100	15x15 cm	1	283.40



**DİK İNİŞ İKİZ GİDER**

Ürün Kodu	Kısa Kod	Çap	Ölçü		Fiyat
<b>10x10</b>					
8102.0A070.10.1	14401	Ø 70	10x10 cm	1	183.40
8102.0A100.10.1	14404	Ø 100	10x10 cm	1	190.00
<b>15x15</b>					
8102.0A070.15.1	14406	Ø 70	15x15 cm	1	220.00
8102.0A100.15.1	14407	Ø 100	15x15 cm	1	226.70



- 8001- Ø 70 Parapet + 8201 Ara Bağlantı + 5101 Sifon Üst Gövde
- 8002- Ø 100 Parapet + 8202 Ara Bağlantı + 5101 Sifon Üst Gövde



- 8001- Ø 70 Parapet + 8201 Ara Bağlantı + 5101 Sifon Üst Gövde
- 8002- Ø 100 Parapet + 8202 Ara Bağlantı + 5101 Sifon Üst Gövde



- Polypropylene

**SHINGLE HAVALANDIRMA**

Ürün Kodu	Kısa Kod	Ölçü		Fiyat	
8010.YD080.00.S	14408	Siyah	34x44x8.5 cm	24	106.70
8010.YD080.00.Y	14411	Yeşil	34x44x8.5 cm	24	106.70
8010.YD080.00.K	14412	Kırmızı	34x44x8.5 cm	24	106.70

# REZERVASYON MONTAJ DETAYLARI

Kat geçiş rezervasyonları iletken olmayan, yüksek darbeye dayanıklı polipropilen malzemeden üretilmiş, hafif ve montaj işçiliği son derece kolay yüksekliği ayarlanabilen modüler ürünlerdir.

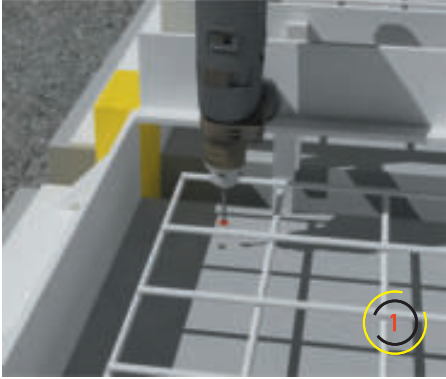

Tünel kalıp sisteminde projede belirlenen noktalar M15 matkapla delinir.



Pullu somun kalıp sisteminin alt kısmına, delinen deliğin merkezine kaynakla sabitlenir. Bu işlem tünel kalıp sisteminde yalnızca bir kez yapılmak tadır.



Donatı demirlerinin döşenmesinin ardından Rezervasyon sistemine ait parçalar tie-rot yardımıyla kalıp sistemine sabitlenmesi sağlanır. Devamında beton dökme işlemi gerçekleştirilerek sistem kullanıma hazır hale gelir.

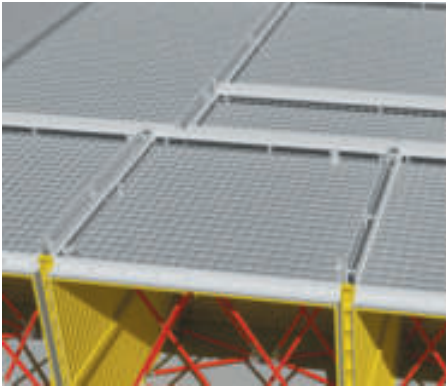

Beton dökümü gerçekleşip kalıplarının sökülmesinin ardından gider tesisatı rezervasyonu hazırdır. Derhal montaj uygulaması yapılabilir.

## MODÜLER REZERVASYON SİSTEMLERİ



**KOD** 25561  
**ÜRÜN ADI** 0101001100050  
KAT GEÇİŞ REZERVASYON  
ALT PARÇA ø 50mm

**FİYAT** 26.70



**KOD** 25562  
**ÜRÜN ADI** 0103001100250  
GİDER SÜZGEÇİ  
REZERVASYONU ø 50mm

**FİYAT** 30.00



**KOD** 25564  
**ÜRÜN ADI** 0104001000010  
KORUMA KAPAĞI

**FİYAT** 16.70



**KOD** 25565  
**ÜRÜN ADI** 0102001100100  
KAT GEÇİŞİ  
REZERVASYONU ø 100mm

**FİYAT** 43.40

# SİSTEM KARŞILAŞTIRMASI

**MAXIFLOW**  
Maksimum akış..

YER  
SIFONLARI

Rezervasyon Adaptörü,  
TSE TS 275-1 EN 1329-1 normunda belirtilen  
pvc atıksu borularına ait ölçüler esas alınarak  
standartlara uygun ölçülendirme yapılmıştır.



SİSTEMLER	LAVABO-KÜVET-DUŞ	KOZET	BAK ON SÜZGEÇ	YER SÜZGEÇİ
ÜRÜN VERİMLİLİĞİ	MODÜLER R.SİSTEMİ	KALIP REZERVASYON		
Kıvrak rezervasyon oluşturmak	Yok	Var	Var	
Kalip ile rezervasyon oluşturmak	Yok	Var	Var	
Rezervasyonda çevre boşluğu doldurma	Yok	Var	Var	
İzolasyonda hasar görme	Yok	Var	Var	
Kırım enasında betonda çatlak oluşma riski	Yok	Var	Var	
*Sürme veya membran izolasyon uygulama ihtiyacı	Yok	Var	Var	
Karotla delik delme işlemi	Yok	Var	Var	
Betonarme kalınlığına göre boy ayarlanabilme	Var	Yok	Yok	
Süzgeç ve gider malzemelerin yardımcı ürünlere ihtiyacı	Yok	Var	Var	
Rezervasyon çevre boşluğundan su sızma problemi	Yok	Var	Var	
Alt toplama montajı esnasında izolasyonun hasar görme riski	Yok	Var	Var	
Stok maliyeti	Yok	Var	Var	
Montaj Kolaylığı	Var	Yok	Yok	
Estetik görüntü	Var	Yok	Yok	
Düşük maliyet	Var	Yok	Yok	
Sisteme müdahale kolaylığı	Var	Yok	Yok	



**KOD** 14200  
**ÜRÜN ADI** 5107 A.Ç. Line  
15x15 SIFON ÜST GÖVDE



**KOD** 14198  
**ÜRÜN ADI** 5101 A.Ç. Line  
10x10 SIFON ÜST GÖVDE



**KOD** 25566  
**ÜRÜN ADI** 0120250103250  
TIE-ROT



**KOD** 25567  
**ÜRÜN ADI** 0121000103251  
TIE-ROT SOMUN

**FİYAT** 120.00

**FİYAT** 76.70

**FİYAT** 136.70

**FİYAT** 133.40



## LINE

Ürün Kodu	Kısa Kod	Çıkış	Ölçü		Fiyat
<b>ALÇAK SEVİYELİ</b>					
4012.0Y050A.020.1	21668	Ø 50	20 cm	12	193.40
4012.0Y050A.033.1	21634	Ø 50	33 cm	12	266.70
4012.0Y050A.040.1	21645	Ø 50	40 cm	12	300.00
4012.0Y050A.050.1	21658	Ø 50	50 cm	12	346.70
4012.0Y050A.060.1	21684	Ø 50	60 cm	12	390.00
<b>ALÇAK SEVİYELİ</b>					
4012.0A050A.020.1	21536	Ø 50	20 cm	12	193.40
4012.0A050A.033.1	21552	Ø 50	33 cm	12	266.70
4012.0A050A.040.1	21565	Ø 50	40 cm	12	300.00
4012.0A050A.050.1	21575	Ø 50	50 cm	12	346.70
4012.0A050A.060.1	21585	Ø 50	60 cm	12	390.00

Duş kanalı / W200-330-400-500-600 mm / Ø 50 yan - alt çıkış  
Plastik gövde / Paslanmaz ızgara / Sulu koku tutucu



**HM-31362**

Kısa koku tutucu kullanılmaktadır.

## LINE

Ürün Kodu	Kısa Kod	Çıkış	Ölçü		Fiyat
<b>YAN ÇIKIŞ</b>					
4012.0Y050K.020.1	14414	Ø 50	20 cm	12	193.40
4012.0Y050K.033.1	14431	Ø 50	33 cm	12	266.70
4012.0Y050K.040.1	14445	Ø 50	40 cm	12	300.00
4012.0Y050K.050.1	14465	Ø 50	50 cm	12	346.70
4012.0Y050K.060.1	14474	Ø 50	60 cm	12	390.00
4012.0Y050K.080.1	14491	Ø 50	80 cm	12	466.70
<b>ALT ÇIKIŞ</b>					
4012.0A050K.020.1	14415	Ø 50	20 cm	12	193.40
4012.0A050K.033.1	14430	Ø 50	33 cm	12	266.70
4012.0A050K.040.1	14448	Ø 50	40 cm	12	300.00
4012.0A050K.050.1	14463	Ø 50	50 cm	12	346.70
4012.0A050K.060.1	14488	Ø 50	60 cm	12	390.00
4012.0A050K.080.1	14503	Ø 50	80 cm	12	466.70

Duş kanalı / W200-330-400-500-600-800 mm / Ø 50 yan - alt çıkış  
Plastik gövde / Paslanmaz ızgara / Sulu koku tutucu



**HM-31361**

Uzun koku tutucu kullanılmaktadır.

**Detaylar**

DN 50 Yan ve Alt çıkış – Pvc boru bağlantılarına uyumlu. sulu tip (36mm) koku önleyiciye sahiptir. Akış hızı 32 lt/dk'dır. Dış kimyasal etkilere dayanım çalışma sıcaklığı -30°+75° arasındadır. Izgarası 304 kalite paslanmaz çeliktir.

**Avantajlar**

304 kalite paslanmaz çelik ızgarası sayesinde şık ve kaliteli bir görünüme sahiptir. Duvar dibi uygulamalarda rahatlıkla uygulanabilir. Su tutuculu koku önleyici sayesinde tesisattan gelecek kötü kokuları önler. Yükseltme ayakları sayesinde şapın yüksekliğine göre ayarlama olanağı sağlar. Organik ve inorganik kimyasallara yüksek dayanım. çoğu asidik ve tuzlu su oksidasyonuna dayanıklıdır.

**Kullanım Alanları**

Genel kullanım banyo duşları. hastane ve otel duş alanları. soyunma odaları duş alanları vb.

**Özel Üretim**

Izgara modeli olarak isteğinize göre altın, bronz gibi renkler de üretilmektedir.

**Uyarı**

Yüksek yoğunluklu temizlik malzemelerinin uzun süreli kullanımı tavsiye edilmez.

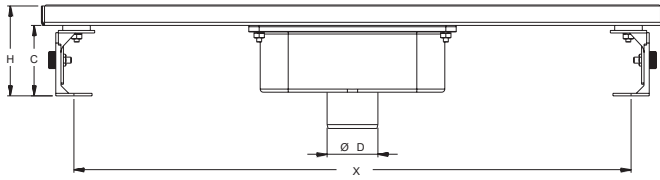
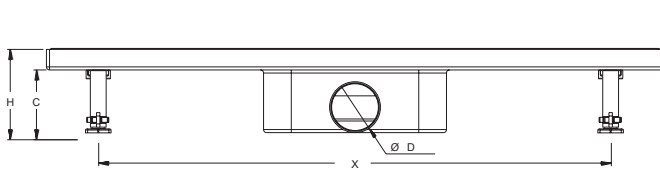
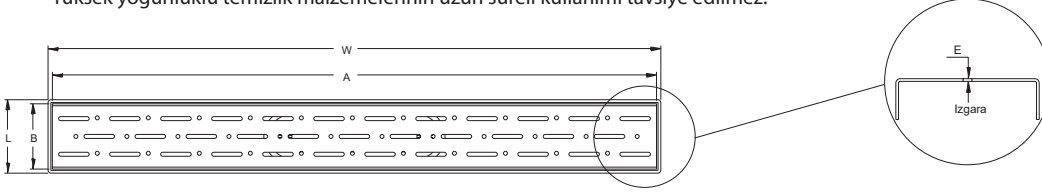

	W	L	H	Ø D	A	B	C	X	E
4012.0Y050K.020.1	205	72	88	49.5	196	64	68	-	1
4012.0Y050K.033.1	330	72	88	49.5	322	64	68	285	1
4012.0Y050K.040.1	400	72	88	49.5	392	64	68	335	1
4012.0Y050K.050.1	500	72	88	49.5	492	64	68	435	1
4012.0Y050K.060.1	600	72	88	49.5	592	64	68	556	1
4012.0Y050K.080.1	785	72	88	49.5	778	64	68	737	1

	W	L	H	Ø D	A	B	C	X	E
4012.0A050K.020.1	205	72	115	49.5	196	64	68	-	1
4012.0A050K.033.1	330	72	115	49.5	322	64	68	285	1
4012.0A050K.040.1	400	72	115	49.5	392	64	68	335	1
4012.0A050K.050.1	500	72	115	49.5	492	64	68	435	1
4012.0A050K.060.1	600	72	115	49.5	592	64	68	556	1
4012.0A050K.080.1	785	72	115	49.5	778	64	68	737	1



## LEGAL

Ürün Kodu	Kısa Kod	Çıkış	Ölçü		Fiyat
<b>YAN ÇIKIŞ</b>					
4013.0Y050K.020.1	14602	Ø 50	20 cm	12	363.40
4013.0Y050K.033.1	14613	Ø 50	33 cm	12	506.70
4013.0Y050K.040.1	14626	Ø 50	40 cm	12	576.70
4013.0Y050K.050.1	14636	Ø 50	50 cm	12	686.70
4013.0Y050K.060.1	14649	Ø 50	60 cm	12	780.00
4013.0Y050K.080.1	14668	Ø 50	80 cm	12	966.70
<b>ALT ÇIKIŞ</b>					
4013.0A050K.020.1	14651	Ø 50	20 cm	12	363.40
4013.0A050K.033.1	14667	Ø 50	33 cm	12	506.70
4013.0A050K.040.1	14685	Ø 50	40 cm	12	576.70
4013.0A050K.050.1	14701	Ø 50	50 cm	12	686.70
4013.0A050K.060.1	14722	Ø 50	60 cm	12	780.00
4013.0A050K.080.1	14734	Ø 50	80 cm	12	966.70

Duş kanalı / W200-330-400-500-600-800 mm / Ø 50 yan - alt çıkış  
Paslanmaz gövde / Paslanmaz ızgara / Sulu koku tutucu

## LEGAL Y360°

Ürün Kodu	Kısa Kod	Çıkış	Ölçü		Fiyat
<b>YAN ÇIKIŞ</b>					
4013.0Y360K.020.1	14879	Ø 50	20 cm	12	436.70
4013.0Y360K.033.1	14902	Ø 50	33 cm	12	586.70
4013.0Y360K.040.1	14916	Ø 50	40 cm	12	656.70
4013.0Y360K.050.1	14928	Ø 50	50 cm	12	773.40
4013.0Y360K.060.1	14937	Ø 50	60 cm	12	870.00
4013.0Y360K.080.1	14946	Ø 50	80 cm	12	1063.40
<b>ALT ÇIKIŞ</b>					
4013.0A360K.020.1	14971	Ø 50	20 cm	12	436.70
4013.0A360K.033.1	14994	Ø 50	33 cm	12	586.70
4013.0A360K.040.1	15007	Ø 50	40 cm	12	656.70
4013.0A360K.050.1	15027	Ø 50	50 cm	12	773.40
4013.0A360K.060.1	15038	Ø 50	60 cm	12	870.00
4013.0A360K.080.1	15050	Ø 50	80 cm	12	1063.40

Duş kanalı / W200-330-400-500-600-800 mm / Ø 50 yan - alt çıkış  
Paslanmaz gövde / Paslanmaz ızgara / Sulu koku tutucu



**HM-31363**

Legal koku tutucu kullanılmaktadır.



**HM-31363**

Legal koku tutucu kullanılmaktadır.



**KLASİK SIMPLE LEGAL**



**HM-31359**

Style koku tutucu kullanılmaktadır.

Ürün Kodu	Kısa Kod	Çıkış	Ölçü	Fiyat
4013.0Y050P020.1	23264	Ø 50	20 cm	393.40
4013.0Y050P033.1	23289	Ø 50	33 cm	510.00
4013.0Y050P040.1	23297	Ø 50	40 cm	580.00
4013.0Y050P050.1	23312	Ø 50	50 cm	686.70
4013.0Y050P060.1	23320	Ø 50	60 cm	786.70
4013.0Y050P080.1	23337	Ø 50	80 cm	980.00

Duş kanalı / W200-330-400-500-600-800 mm / Ø 50 yan - alt çıkış  
Paslanmaz gövde / Paslanmaz ızgara / Sulu koku tutucu

**LEGAL**



**HM-31359**

Style koku tutucu kullanılmaktadır.

Ürün Kodu	Kısa Kod	Çıkış	Ölçü	Fiyat
<b>YAN ÇIKIŞ</b>				
4015.0Y050P020.1	31213	Ø 50	20 cm	433.40
4015.0Y050P033.1	31217	Ø 50	33 cm	550.00
4015.0Y050P040.1	31221	Ø 50	40 cm	620.00
4015.0Y050P050.1	31225	Ø 50	50 cm	726.70
4015.0Y050P060.1	31229	Ø 50	60 cm	830.00
4015.0Y050P080.1	31233	Ø 50	80 cm	1040.00

**ALT ÇIKIŞ**

4015.0A050P020.1	31237	Ø 50	20 cm	433.40
4015.0A050P033.1	31241	Ø 50	33 cm	550.00
4015.0A050P040.1	31245	Ø 50	40 cm	620.00
4015.0A050P050.1	31248	Ø 50	50 cm	726.70
4015.0A050P060.1	31253	Ø 50	60 cm	830.00
4015.0A050P080.1	31257	Ø 50	80 cm	1040.00

Duş kanalı / W200-330-400-500-600-800 mm / Ø 50 yan - alt çıkış  
Paslanmaz gövde / Paslanmaz ızgara / Sulu koku tutucu

**LEGAL Y360°**



**HM-31359**

Style koku tutucu kullanılmaktadır.

Ürün Kodu	Kısa Kod	Çıkış	Ölçü	Fiyat
<b>YAN ÇIKIŞ</b>				
4018.0Y050P020.1	31273	Ø 50	20 cm	470.00
4018.0Y050P033.1	31277	Ø 50	33 cm	593.40
4018.0Y050P040.1	31281	Ø 50	40 cm	666.70
4018.0Y050P050.1	31285	Ø 50	50 cm	780.00
4018.0Y050P060.1	31289	Ø 50	60 cm	876.70
4018.0Y050P080.1	31293	Ø 50	80 cm	1073.40

**ALT ÇIKIŞ**

4018.0A050P020.1	31487	Ø 50	20 cm	470.00
4018.0A050P033.1	31491	Ø 50	33 cm	593.40
4018.0A050P040.1	31495	Ø 50	40 cm	666.70
4018.0A050P050.1	31499	Ø 50	50 cm	780.00
4018.0A050P060.1	31503	Ø 50	60 cm	876.70
4018.0A050P080.1	31507	Ø 50	80 cm	1073.40

Duş kanalı / W200-330-400-500-600-800 mm / Ø 50 yan - alt çıkış  
Paslanmaz gövde / Paslanmaz ızgara / Sulu koku tutucu

## SCALA

Ürün Kodu	Kısa Kod	Çıkış	Ölçü		Fiyat
<b>YAN ÇIKIŞ</b>					
4014.0Y050K.020.1	15086	Ø 50	20 cm	12	383.40
4014.0Y050K.033.1	15087	Ø 50	33 cm	12	526.70
4014.0Y050K.040.1	15088	Ø 50	40 cm	12	596.70
4014.0Y050K.050.1	15090	Ø 50	50 cm	12	710.00
4014.0Y050K.060.1	15092	Ø 50	60 cm	12	803.40
4014.0Y050K.080.1	15095	Ø 50	80 cm	12	990.00
<b>ALT ÇIKIŞ</b>					
4014.0A050K.020.1	15072	Ø 50	20 cm	12	383.40
4014.0A050K.033.1	15076	Ø 50	33 cm	12	526.70
4014.0A050K.040.1	15078	Ø 50	40 cm	12	596.70
4014.0A050K.050.1	15080	Ø 50	50 cm	12	710.00
4014.0A050K.060.1	15082	Ø 50	60 cm	12	803.40
4014.0A050K.080.1	15084	Ø 50	80 cm	12	990.00

Duş kanalı / W200-330-400-500-600-800 mm / Ø 50 yan - alt çıkış  
Paslanmaz gövde / Paslanmaz seramik uyumlu çerçeve / Sulu koku tutucu



**HM-31363**

Legal koku tutucu kullanılmaktadır.

## SCALA Y360°

Ürün Kodu	Kısa Kod	Çıkış	Ölçü		Fiyat
<b>YAN ÇIKIŞ</b>					
4014.0Y360K.020.1	15110	Ø 50	20 cm	12	490.00
4014.0Y360K.033.1	15112	Ø 50	33 cm	12	633.40
4014.0Y360K.040.1	15114	Ø 50	40 cm	12	710.00
4014.0Y360K.050.1	15116	Ø 50	50 cm	12	810.00
4014.0Y360K.060.1	15117	Ø 50	60 cm	12	876.70
4014.0Y360K.080.1	15118	Ø 50	80 cm	12	1070.00
<b>ALT ÇIKIŞ</b>					
4014.0A360K.020.1	31365	Ø 50	20 cm	12	490.00
4014.0A360K.033.1	31366	Ø 50	33 cm	12	633.40
4014.0A360K.040.1	31367	Ø 50	40 cm	12	710.00
4014.0A360K.050.1	31368	Ø 50	50 cm	12	810.00
4014.0A360K.060.1	31369	Ø 50	60 cm	12	876.70
4014.0A360K.080.1	31370	Ø 50	80 cm	12	1070.00

Duş kanalı / W200-330-400-500-600-800 mm / Ø 50 yan - alt çıkış  
Paslanmaz gövde / Paslanmaz seramik uyumlu çerçeve / Sulu koku tutucu



**HM-31363**

Legal koku tutucu kullanılmaktadır.

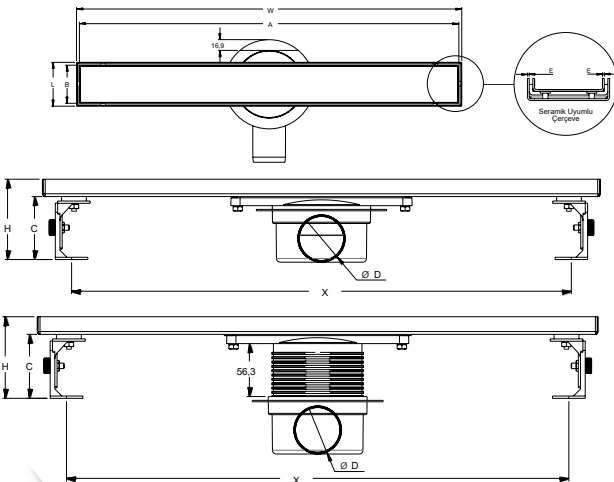

### ÜRÜN KODU

ÜRÜN KODU	W	L	H	Ø D	A	B	C	X	E
4014.00360K.033.1	330	72	88	49.5	316	58	68	285	1.5
4014.00360K.040.1	400	72	88	49.5	388	58	68	335	1.5
4014.00360K.050.1	500	72	88	49.5	487	58	68	435	1.5
4014.00360K.060.1	600	72	88	49.5	589	58	68	556	1.5
4014.00360K.080.1	785	72	88	49.5	773	58	68	737	1.5

### ÜRÜN KODU

ÜRÜN KODU	W	L	H	Ø D	A	B	C	X	E
4014.0Y360K.033.1	330	72	154	49.5	316	58	68	285	1.5
4014.0Y360K.040.1	400	72	154	49.5	388	58	68	335	1.5
4014.0Y360K.050.1	500	72	154	49.5	487	58	68	435	1.5
4014.0Y360K.060.1	600	72	154	49.5	589	58	68	556	1.5
4014.0Y360K.080.1	785	72	154	49.5	773	58	68	737	1.5

Tablo ölçü birimi "mm"dir.

# STYLE SERİSİ

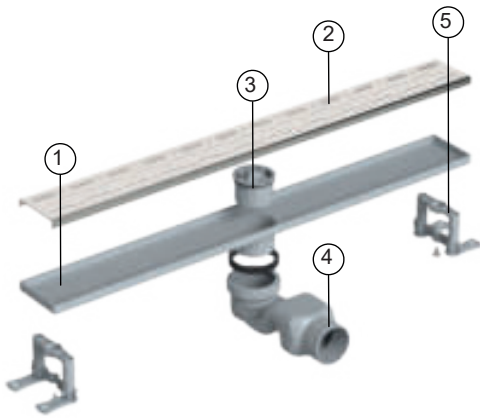

PARÇA NO	PARÇA AÇIKLAMASI	MALZEME	ADET
4083.1	Paslanmaz Üst Gövde	AISI 304	1
4083.2	Paslanmaz Izgara	AISI 304	1
4083.3	Koku Tutucu	PP	1
4083.4	S Sifon	PP	1
4083.5	Yükseklik Ayarlı Montaj Seti	PP	2

## Detaylar

DN 50 Yan ve Alt çıkış – Pvc boru bağlantılarına uyumludur. Akış hızı 32 lt/dk'dır. Izgarası 304 kalite paslanmaz çeliktir.

## Avantajlar

304 kalite paslanmaz çelik ızgarası sayesinde şık ve kaliteli bir görünüme sahiptir. Duvar dibi uygulamalarda rahatlıkla uygulanabilir. Su tutuculu koku önleyici sayesinde tesisattan gelecek kötü kokuları önler. Yükseltme ayakları sayesinde şapın yüksekliğine göre ayarlama olanağı sağlar. Organik ve inorganik kimyasallara yüksek dayanım. çoğu asidik ve tuzlu su oksidasyonuna dayanıklıdır.

## Kullanım Alanları

Genel kullanım banyo duşları, hastane ve otel duş alanları, soyunma odaları duş alanları vb.

## Özel Üretim

Izgara modeli olarak isteğinize göre altın, bronz gibi renkler de üretilmektedir.

## Uyarı

Yüksek yoğunluklu temizlik malzemelerinin uzun süreli kullanımı tavsiye edilmez.

## SIMPLE LINE

Ürün Kodu	Kısa Kod	Çıkış	Ölçü		Fiyat
<b>ALT ÇIKIŞ</b>					
4080.0A050K.033.1	15119	Ø 50	33 cm	12	200.00
4080.0A050K.040.1	15148	Ø 50	40 cm	12	236.70
4080.0A050K.050.1	15162	Ø 50	50 cm	12	276.70
4080.0A050K.060.1	15199	Ø 50	60 cm	12	316.70
4080.0A050K.080.1	15216	Ø 50	80 cm	12	386.70

Duş kanalı / W330-400-500-600-800 mm / Ø 50 yan - alt çıkış  
Plastik gövde / Paslanmaz ızgara / Sulu koku tutucu



**HM-31359**

Style koku tutucu kullanılmaktadır.

## LINE

Ürün Kodu	Kısa Kod	Çıkış	Ölçü		Fiyat
<b>YAN ÇIKIŞ</b>					
4081.0Y050K.033.1	15160	Ø 50	33 cm	12	253.40
4081.0Y050K.040.1	15172	Ø 50	40 cm	12	286.70
4081.0Y050K.050.1	15187	Ø 50	50 cm	12	323.40
4081.0Y050K.060.1	15197	Ø 50	60 cm	12	370.00
4081.0Y050K.080.1	15213	Ø 50	80 cm	12	453.40
<b>ALT ÇIKIŞ</b>					
4082.0A050K.033.1	15228	Ø 50	33 cm	12	253.40
4082.0A050K.040.1	15239	Ø 50	40 cm	12	286.70
4082.0A050K.050.1	15254	Ø 50	50 cm	12	323.40
4082.0A050K.060.1	15269	Ø 50	60 cm	12	370.00
4082.0A050K.080.1	15295	Ø 50	80 cm	12	453.40

Duş kanalı / W330-400-500-600-800 mm / Ø 50 yan - alt çıkış  
Plastik gövde / Paslanmaz ızgara / Sulu koku tutucu



**HM-31359**

Style koku tutucu kullanılmaktadır.

## LINE FİLELİ

Ürün Kodu	Kısa Kod	Çıkış	Ölçü		Fiyat
<b>YAN ÇIKIŞ</b>					
4092.FY050K.033.1	15585	Ø 50	33 cm	12	273.40
4092.FY050K.040.1	15603	Ø 50	40 cm	12	303.40
4092.FY050K.050.1	15623	Ø 50	50 cm	12	353.40
4092.FY050K.060.1	15637	Ø 50	60 cm	12	390.00
4092.FY050K.080.1	15647	Ø 50	80 cm	12	463.40
<b>ALT ÇIKIŞ</b>					
4093.FA050K.033.1	15591	Ø 50	33 cm	12	273.40
4093.FA050K.040.1	15613	Ø 50	40 cm	12	303.40
4093.FA050K.050.1	15635	Ø 50	50 cm	12	353.40
4093.FA050K.060.1	15662	Ø 50	60 cm	12	390.00
4093.FA050K.080.1	15698	Ø 50	80 cm	12	463.40

Duş kanalı / W330-400-500-600-800 mm / Ø 50 yan - alt çıkış  
Plastik gövde / Paslanmaz ızgara / Sulu koku tutucu

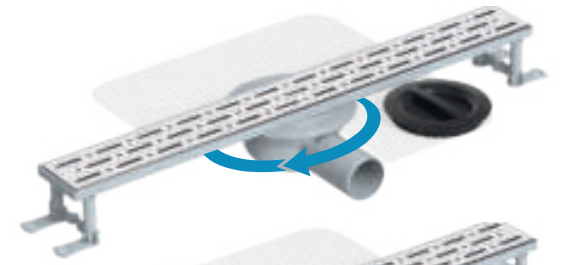

**HM-31359**

Style koku tutucu kullanılmaktadır.



RAIN



KARE



BAHN



**HM-31359**

Style koku tutucu kullanılmaktadır.

**STYLE SİFONİK**

Ürün Kodu	Kısa Kod	Çıkış	Ölçü	Fiyat
<b>YAN ÇIKIŞ</b>				
4083.0Y050K.033.1	15243	Ø 50	33 cm	253.40
4083.0Y050K.040.1	15270	Ø 50	40 cm	283.40
4083.0Y050K.050.1	15282	Ø 50	50 cm	323.40
4083.0Y050K.060.1	15300	Ø 50	60 cm	366.70
4083.0Y050K.080.1	15312	Ø 50	80 cm	433.40

Duş kanalı / W330-400-500-600-800 mm / Ø 50 yan - alt çıkış  
Plastik gövde / Paslanmaz ızgara / Sulu koku tutucu

**LINE Y360°**

Ürün Kodu	Kısa Kod	Çıkış	Ölçü	Fiyat
<b>YAN ÇIKIŞ</b>				
4085.0Y050K.033.1	29857	Ø 50	33 cm	303.40
4085.0Y050K.040.1	29860	Ø 50	40 cm	336.70
4085.0Y050K.050.1	29863	Ø 50	50 cm	383.40
4085.0Y050K.060.1	29866	Ø 50	60 cm	423.40
4085.0Y050K.080.1	29869	Ø 50	80 cm	493.40
<b>ALT ÇIKIŞ</b>				
4085.0A050K.033.1	29872	Ø 50	33 cm	303.40
4085.0A050K.040.1	29875	Ø 50	40 cm	336.70
4085.0A050K.050.1	29878	Ø 50	50 cm	383.40
4085.0A050K.060.1	29881	Ø 50	60 cm	423.40
4085.0A050K.080.1	29884	Ø 50	80 cm	493.40

Duş kanalı / W330-400-500-600-800 mm / Ø 50 yan - alt çıkış  
Plastik gövde / Paslanmaz ızgara / Sulu koku tutucu

**LINE FİLELİ Y360°**

Ürün Kodu	Kısa Kod	Çıkış	Ölçü	Fiyat
<b>YAN ÇIKIŞ</b>				
4090.FY050K.033.1	29935	Ø 50	33 cm	313.40
4090.FY050K.040.1	29939	Ø 50	40 cm	343.40
4090.FY050K.050.1	29943	Ø 50	50 cm	393.40
4090.FY050K.060.1	29947	Ø 50	60 cm	430.00
4090.FY050K.080.1	29951	Ø 50	80 cm	503.40
<b>ALT ÇIKIŞ</b>				
4090.FA050K.033.1	29955	Ø 50	33 cm	313.40
4090.FA050K.040.1	29959	Ø 50	40 cm	343.40
4090.FA050K.050.1	29963	Ø 50	50 cm	393.40
4090.FA050K.060.1	29967	Ø 50	60 cm	430.00
4090.FA050K.080.1	29971	Ø 50	80 cm	503.40

Duş kanalı / W330-400-500-600-800 mm / Ø 50 yan - alt çıkış  
Plastik gövde / Paslanmaz ızgara / Sulu koku tutucu



**HM-31359**

Style koku tutucu kullanılmaktadır.



RAIN

KARE

BAHN



## SIMPLE LEGAL

Ürün Kodu	Kısa Kod	Çıkış	Ölçü		Fiyat
<b>ALT ÇIKIŞ</b>					
4086.0A050K.020.1	15329	Ø 50	20 cm	12	256.70
4086.0A050K.033.1	15338	Ø 50	33 cm	12	326.70
4086.0A050K.040.1	15347	Ø 50	40 cm	12	403.40
4086.0A050K.050.1	15363	Ø 50	50 cm	12	480.00
4086.0A050K.060.1	15381	Ø 50	60 cm	12	553.40
4086.0A050K.080.1	15420	Ø 50	80 cm	12	690.00

Duş kanalı / W200-330-400-500-600-800 mm / Ø 50 yan - alt çıkış  
Paslanmaz gövde / Paslanmaz ızgara / Sulu koku tutucu



**HM-31359**

Style koku tutucu kullanılmaktadır.

## LEGAL

Ürün Kodu	Kısa Kod	Çıkış	Ölçü		Fiyat
<b>YAN ÇIKIŞ</b>					
4087.0Y050K.020.1	15445	Ø 50	20 cm	12	290.00
4087.0Y050K.033.1	15471	Ø 50	33 cm	12	360.00
4087.0Y050K.040.1	15490	Ø 50	40 cm	12	440.00
4087.0Y050K.050.1	15508	Ø 50	50 cm	12	513.40
4087.0Y050K.060.1	15532	Ø 50	60 cm	12	590.00
4087.0Y050K.080.1	15580	Ø 50	80 cm	12	750.00
<b>ALT ÇIKIŞ</b>					
4088.0A050K.020.1	15321	Ø 50	20 cm	12	290.00
4088.0A050K.033.1	15366	Ø 50	33 cm	12	360.00
4088.0A050K.040.1	15383	Ø 50	40 cm	12	440.00
4088.0A050K.050.1	15396	Ø 50	50 cm	12	513.40
4088.0A050K.060.1	15417	Ø 50	60 cm	12	590.00
4088.0A050K.080.1	15446	Ø 50	80 cm	12	750.00

Duş kanalı / W200-330-400-500-600-800 mm / Ø 50 yan - alt çıkış  
Paslanmaz gövde / Paslanmaz ızgara / Sulu koku tutucu



**HM-31359**

Style koku tutucu kullanılmaktadır.

## LEGAL FİLELİ

Ürün Kodu	Kısa Kod	Çıkış	Ölçü		Fiyat
<b>YAN ÇIKIŞ</b>					
4094.FY050K.020.1	15665	Ø 50	20 cm	12	363.40
4094.FY050K.033.1	15680	Ø 50	33 cm	12	446.70
4094.FY050K.040.1	15692	Ø 50	40 cm	12	526.70
4094.FY050K.050.1	15706	Ø 50	50 cm	12	623.40
4094.FY050K.060.1	15731	Ø 50	60 cm	12	703.40
4094.FY050K.080.1	15784	Ø 50	80 cm	12	863.40
<b>ALT ÇIKIŞ</b>					
4094.FA050K.020.1	15714	Ø 50	20 cm	12	363.40
4094.FA050K.033.1	15728	Ø 50	33 cm	12	446.70
4094.FA050K.040.1	15740	Ø 50	40 cm	12	526.70
4094.FA050K.050.1	15754	Ø 50	50 cm	12	623.40
4094.FA050K.060.1	15767	Ø 50	60 cm	12	703.40
4094.FA050K.080.1	15793	Ø 50	80 cm	12	863.40

Duş kanalı / W200-330-400-500-600-800 mm / Ø 50 yan - alt çıkış  
Paslanmaz gövde / Paslanmaz ızgara / Sulu koku tutucu

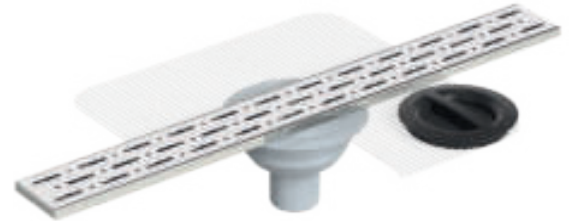

**HM-31359**

Style koku tutucu kullanılmaktadır.



RAIN

KARE

BAHN



**HM-31359**

Style koku tutucu kullanılmaktadır.

**LEGAL SİFONİK**

Ürün Kodu	Kısa Kod	Çıkış	Ölçü		Fiyat
<b>YAN ÇIKIŞ</b>					
4084.0Y050K.020.1	15457	Ø 50	20 cm	12	286.70
4084.0Y050K.033.1	15479	Ø 50	33 cm	12	360.00
4084.0Y050K.040.1	15495	Ø 50	40 cm	12	430.00
4084.0Y050K.050.1	15517	Ø 50	50 cm	12	506.70
4084.0Y050K.060.1	15536	Ø 50	60 cm	12	566.70
4084.0Y050K.080.1	15565	Ø 50	80 cm	12	720.00

Duş kanalı / W200-330-400-500-600-800 mm / Ø 50 yan - alt çıkış  
Paslanmaz gövde / Paslanmaz ızgara / Sulu koku tutucu

**LEGAL Y360°**

Ürün Kodu	Kısa Kod	Çıkış	Ölçü		Fiyat
<b>YAN ÇIKIŞ</b>					
4089.0Y050K.020.1	29887	Ø 50	20 cm	12	360.00
4089.0Y050K.033.1	29891	Ø 50	33 cm	12	433.40
4089.0Y050K.040.1	29895	Ø 50	40 cm	12	506.70
4089.0Y050K.050.1	29899	Ø 50	50 cm	12	596.70
4089.0Y050K.060.1	29903	Ø 50	60 cm	12	670.00
4089.0Y050K.080.1	29907	Ø 50	80 cm	12	813.40

**ALT ÇIKIŞ**

4089.0A050K.020.1	29911	Ø 50	20 cm	12	360.00
4089.0A050K.033.1	29915	Ø 50	33 cm	12	433.40
4089.0A050K.040.1	29919	Ø 50	40 cm	12	506.70
4089.0A050K.050.1	29923	Ø 50	50 cm	12	596.70
4089.0A050K.060.1	29927	Ø 50	60 cm	12	670.00
4089.0A050K.080.1	29931	Ø 50	80 cm	12	813.40

Duş kanalı / W200-330-400-500-600-800 mm / Ø 50 yan - alt çıkış  
Paslanmaz gövde / Paslanmaz ızgara / Sulu koku tutucu



**HM-31359**

Style koku tutucu kullanılmaktadır.

**LEGAL FİLELİ Y360°**

Ürün Kodu	Kısa Kod	Çıkış	Ölçü		Fiyat
<b>YAN ÇIKIŞ</b>					
4095.FY050K.020.1	30753	Ø 50	20 cm	12	393.40
4095.FY050K.033.1	29975	Ø 50	33 cm	12	473.40
4095.FY050K.040.1	29979	Ø 50	40 cm	12	553.40
4095.FY050K.050.1	29983	Ø 50	50 cm	12	650.00
4095.FY050K.060.1	29987	Ø 50	60 cm	12	730.00
4095.FY050K.080.1	29991	Ø 50	80 cm	12	890.00

**ALT ÇIKIŞ**

4095.FA050K.020.1	30757	Ø 50	20 cm	12	393.40
4095.FA050K.033.1	29995	Ø 50	33 cm	12	473.40
4095.FA050K.040.1	29999	Ø 50	40 cm	12	553.40
4095.FA050K.050.1	30003	Ø 50	50 cm	12	650.00
4095.FA050K.060.1	30007	Ø 50	60 cm	12	730.00
4095.FA050K.080.1	30011	Ø 50	80 cm	12	890.00

Duş kanalı / W200-330-400-500-600-800 mm / Ø 50 yan - alt çıkış  
Paslanmaz gövde / Paslanmaz ızgara / Sulu koku tutucu



**HM-31359**

Style koku tutucu kullanılmaktadır.



RAIN

KARE

BAHN

## SİMPLE VEGA

Ürün Kodu	Kısa Kod	Çıkış	Ölçü		Fiyat
<b>ALT ÇIKIŞ</b>					
4074.0A050K.040.1	15802	Ø 50	40 cm	12	380.00
4074.0A050K.050.1	15812	Ø 50	50 cm	12	426.70
4074.0A050K.060.1	15821	Ø 50	60 cm	12	480.00

Duş kanalı / W200-330-400-500-600-800 mm / Ø 50 yan - alt çıkış  
Paslanmaz gövde / Paslanmaz ızgara / Sulu koku tutucu



**HM-31359**

Style koku tutucu kullanılmaktadır.

## VEGA

Ürün Kodu	Kısa Kod	Çıkış	Ölçü		Fiyat
<b>YAN ÇIKIŞ</b>					
4075.0Y050K.040.1	15830	Ø 50	40 cm	12	430.00
4075.0Y050K.050.1	15843	Ø 50	50 cm	12	480.00
4075.0Y050K.060.1	15858	Ø 50	60 cm	12	540.00
<b>ALT ÇIKIŞ</b>					
4075.0A050K.040.1	15835	Ø 50	40 cm	12	430.00
4075.0A050K.050.1	15856	Ø 50	50 cm	12	480.00
4075.0A050K.060.1	15871	Ø 50	60 cm <td 12	540.00	

Duş kanalı / W200-330-400-500-600-800 mm / Ø 50 yan - alt çıkış  
Paslanmaz gövde / Paslanmaz ızgara / Sulu koku tutucu



**HM-31359**

Style koku tutucu kullanılmaktadır.

## VEGA FİLELİ

Ürün Kodu	Kısa Kod	Çıkış	Ölçü		Fiyat
<b>YAN ÇIKIŞ</b>					
4075.FY050K.040.1	16002	Ø 50	40 cm	12	453.40
4075.FY050K.050.1	16011	Ø 50	50 cm	12	523.40
4075.FY050K.060.1	16020	Ø 50	60 cm	12	583.40
<b>ALT ÇIKIŞ</b>					
4075.FA050K.040.1	16031	Ø 50	40 cm	12	453.40
4075.FA050K.050.1	16051	Ø 50	50 cm	12	523.40
4075.FA050K.060.1	16066	Ø 50	60 cm	12	583.40

Duş kanalı / W200-330-400-500-600-800 mm / Ø 50 yan - alt çıkış  
Paslanmaz gövde / Paslanmaz ızgara / Sulu koku tutucu

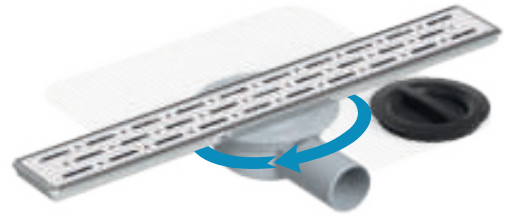

**HM-31359**

Style koku tutucu kullanılmaktadır.



RAIN

KARE

BAHN



**HM-31359**

Style koku tutucu kullanılmaktadır.

**VEGA SİFONİK**

Ürün Kodu	Kısa Kod	Çıkış	Ölçü	Fiyat	
<b>YAN ÇIKIŞ</b>					
4076.0Y050K.040.1	15882	Ø 50	40 cm	12	413.40
4076.0Y050K.050.1	15911	Ø 50	50 cm	12	460.00
4076.0Y050K.060.1	15925	Ø 50	60 cm	12	516.70

Duş kanalı / W200-330-400-500-600-800 mm / Ø 50 yan - alt çıkış  
Paslanmaz gövde / Paslanmaz ızgara / Sulu koku tutucu

**VEGA Y360°**

Ürün Kodu	Kısa Kod	Çıkış	Ölçü	Fiyat	
<b>YAN ÇIKIŞ</b>					
4070.0Y050K.040.1	30025	Ø 50	40 cm	12	473.40
4070.0Y050K.050.1	30029	Ø 50	50 cm	12	533.40
4070.0Y050K.060.1	30033	Ø 50	60 cm	12	586.70
<b>ALT ÇIKIŞ</b>					
4070.0A050K.040.1	30037	Ø 50	40 cm	12	473.40
4070.0A050K.050.1	30041	Ø 50	50 cm	12	533.40
4070.0A050K.060.1	30045	Ø 50	60 cm	12	586.70

Duş kanalı / W200-330-400-500-600-800 mm / Ø 50 yan - alt çıkış  
Paslanmaz gövde / Paslanmaz ızgara / Sulu koku tutucu



**HM-31359**

Style koku tutucu kullanılmaktadır.

**VEGA FİLELİ Y360°**

Ürün Kodu	Kısa Kod	Çıkış	Ölçü	Fiyat	
<b>YAN ÇIKIŞ</b>					
4069.FY050K.040.1	30073	Ø 50	40 cm	12	470.00
4069.FY050K.050.1	30077	Ø 50	50 cm	12	550.00
4069.FY050K.060.1	30081	Ø 50	60 cm	12	600.00
<b>ALT ÇIKIŞ</b>					
4069.FA050K.040.1	30085	Ø 50	40 cm	12	470.00
4069.FA050K.050.1	30089	Ø 50	50 cm	12	550.00
4069.FA050K.060.1	30093	Ø 50	60 cm	12	600.00

Duş kanalı / W200-330-400-500-600-800 mm / Ø 50 yan - alt çıkış  
Paslanmaz gövde / Paslanmaz ızgara / Sulu koku tutucu



**HM-31359**

Style koku tutucu kullanılmaktadır.



RAIN

KARE

BAHN

### SİMPLE VEGA LUX

Ürün Kodu	Kısa Kod	Çıkış	Ölçü		Fiyat
<b>ALT ÇIKIŞ</b>					
4077.0A050K.040.1	15886	Ø 50	40 cm	12	446.70
4077.0A050K.050.1	15901	Ø 50	50 cm	12	513.40
4077.0A050K.060.1	15917	Ø 50	60 cm	12	556.70

Duş kanalı / W200-330-400-500-600-800 mm / Ø 50 yan - alt çıkış  
Paslanmaz gövde / Paslanmaz çerçeve ve ızgara / Sulu koku tutucu



**HM-31359**

Style koku tutucu kullanılmaktadır.

### VEGA LUX

Ürün Kodu	Kısa Kod	Çıkış	Ölçü		Fiyat
<b>YAN ÇIKIŞ</b>					
4078.0Y050K.040.1	15935	Ø 50	40 cm	12	496.70
4078.0Y050K.050.1	15952	Ø 50	50 cm	12	566.70
4078.0Y050K.060.1	15961	Ø 50	60 cm	12	636.70
<b>ALT ÇIKIŞ</b>					
4078.0A050K.040.1	15943	Ø 50	40 cm	12	496.70
4078.0A050K.050.1	16046	Ø 50	50 cm	12	566.70
4078.0A050K.060.1	16071	Ø 50	60 cm	12	636.70

Duş kanalı / W200-330-400-500-600-800 mm / Ø 50 yan - alt çıkış  
Paslanmaz gövde / Paslanmaz çerçeve ve ızgara / Sulu koku tutucu



**HM-31359**

Style koku tutucu kullanılmaktadır.

### VEGA LUX FİLELİ

Ürün Kodu	Kısa Kod	Çıkış	Ölçü		Fiyat
<b>YAN ÇIKIŞ</b>					
4078.FY050K.040.1	16083	Ø 50	40 cm	12	520.00
4078.FY050K.050.1	16094	Ø 50	50 cm	12	586.70
4078.FY050K.060.1	16117	Ø 50	60 cm	12	636.70
<b>ALT ÇIKIŞ</b>					
4078.FA050K.040.1	16086	Ø 50	40 cm	12	520.00
4078.FA050K.050.1	16109	Ø 50	50 cm	12	586.70
4078.FA050K.060.1	16143	Ø 50	60 cm	12	636.70

Duş kanalı / W200-330-400-500-600-800 mm / Ø 50 yan - alt çıkış  
Paslanmaz gövde / Paslanmaz çerçeve ve ızgara / Sulu koku tutucu



**HM-31359**

Style koku tutucu kullanılmaktadır.



RAIN

KARE

BAHN



**HM-31359**

Style koku tutucu kullanılmaktadır.

**VEGA LUX SIFONİK**

Ürün Kodu	Kısa Kod	Çıkış	Ölçü	Fiyat
<b>YAN ÇIKIŞ</b>				
4079.0Y050K.040.1	15971	Ø 50	40 cm	12 473.40
4079.0Y050K.050.1	15981	Ø 50	50 cm	12 536.70
4079.0Y050K.060.1	15991	Ø 50	60 cm	12 583.40

Duş kanalı / W200-330-400-500-600-800 mm / Ø 50 yan - alt çıkış  
Paslanmaz gövde / Paslanmaz çerçeve ve ızgara / Sulu koku tutucu

**VEGA LUX Y360°**



**HM-31359**

Style koku tutucu kullanılmaktadır.

Ürün Kodu	Kısa Kod	Çıkış	Ölçü	Fiyat
<b>YAN ÇIKIŞ</b>				
4071.0Y050K.040.1	30049	Ø 50	40 cm	12 546.70
4071.0Y050K.050.1	30053	Ø 50	50 cm	12 620.00
4071.0Y050K.060.1	30057	Ø 50	60 cm	12 690.00
<b>ALT ÇIKIŞ</b>				
4071.0A050K.040.1	30061	Ø 50	40 cm	12 546.70
4071.0A050K.050.1	30065	Ø 50	50 cm	12 620.00
4071.0A050K.060.1	30069	Ø 50	60 cm	12 690.00

Duş kanalı / W200-330-400-500-600-800 mm / Ø 50 yan - alt çıkış  
Paslanmaz gövde / Paslanmaz çerçeve ve ızgara / Sulu koku tutucu

**VEGA LUX FİLELİ Y360°**



**HM-31359**

Style koku tutucu kullanılmaktadır.

Ürün Kodu	Kısa Kod	Çıkış	Ölçü	Fiyat
<b>YAN ÇIKIŞ</b>				
4068.FY050K.040.1	30792	Ø 50	40 cm	12 556.70
4068.FY050K.050.1	30796	Ø 50	50 cm	12 626.70
4068.FY050K.060.1	30800	Ø 50	60 cm	12 673.40
<b>ALT ÇIKIŞ</b>				
4068.FA050K.040.1	30804	Ø 50	40 cm	12 556.70
4068.FA050K.050.1	30808	Ø 50	50 cm	12 626.70
4068.FA050K.060.1	30812	Ø 50	60 cm	12 673.40

Duş kanalı / W200-330-400-500-600-800 mm / Ø 50 yan - alt çıkış  
Paslanmaz gövde / Paslanmaz çerçeve ve ızgara / Sulu koku tutucu



**RAIN**

**KARE**

**BAHN**

## SİMPLE ALFA

Ürün Kodu	Kısa Kod	Çıkış	Ölçü		Fiyat
<b>ALT ÇIKIŞ</b>					
4060.0A050K.020.1	29724	Ø 50	20 cm	12	273.40
4060.0A050K.030.1	29726	Ø 50	30 cm	12	346.70
4060.0A050K.040.1	28913	Ø 50	40 cm	12	423.40
4060.0A050K.050.1	28914	Ø 50	50 cm	12	496.70
4060.0A050K.060.1	28915	Ø 50	60 cm	12	573.40

Duş kanalı / W200-330-400-500-600-800 mm / Ø 50 yan - alt çıkış  
Paslanmaz gövde / Paslanmaz ızgara / Sulu koku tutucu



**HM-31359**

Style koku tutucu kullanılmaktadır.

## ALFA

Ürün Kodu	Kısa Kod	Çıkış	Ölçü		Fiyat
<b>YAN ÇIKIŞ</b>					
4060.0Y050K.020.1	29723	Ø 50	20 cm	12	316.70
4060.0Y050K.030.1	29725	Ø 50	30 cm	12	393.40
4060.0Y050K.040.1	28919	Ø 50	40 cm	12	473.40
4060.0Y050K.050.1	28920	Ø 50	50 cm	12	550.00
4060.0Y050K.060.1	28921	Ø 50	60 cm	12	630.00
<b>ALT ÇIKIŞ</b>					
4067.0A050K.020.1	31372	Ø 50	20 cm	12	316.70
4067.0A050K.030.1	31373	Ø 50	30 cm	12	393.40
4067.0A050K.040.1	31374	Ø 50	40 cm	12	473.40
4067.0A050K.050.1	31375	Ø 50	50 cm	12	550.00
4067.0A050K.060.1	31376	Ø 50	60 cm	12	630.00

Duş kanalı / W200-330-400-500-600-800 mm / Ø 50 yan - alt çıkış  
Paslanmaz gövde / Paslanmaz ızgara / Sulu koku tutucu



**HM-31359**

Style koku tutucu kullanılmaktadır.

## ALFA Y360°

Ürün Kodu	Kısa Kod	Çıkış	Ölçü		Fiyat
<b>YAN ÇIKIŞ</b>					
4064.0Y050K.020.1	30015	Ø 50	20 cm	12	373.40
4064.0Y050K.030.1	30016	Ø 50	30 cm	12	446.70
4064.0Y050K.040.1	30017	Ø 50	40 cm	12	523.40
4064.0Y050K.050.1	30018	Ø 50	50 cm	12	603.40
4064.0Y050K.060.1	30019	Ø 50	60 cm	12	676.70
<b>ALT ÇIKIŞ</b>					
4064.0A050K.020.1	30761	Ø 50	20 cm	12	373.40
4064.0A050K.030.1	30762	Ø 50	30 cm	12	446.70
4064.0A050K.040.1	30763	Ø 50	40 cm	12	523.40
4064.0A050K.050.1	30764	Ø 50	50 cm	12	603.40
4064.0A050K.060.1	30765	Ø 50	60 cm	12	676.70

Duş kanalı / W200-330-400-500-600-800 mm / Ø 50 yan - alt çıkış  
Paslanmaz gövde / Paslanmaz ızgara / Sulu koku tutucu



**HM-31359**

Style koku tutucu kullanılmaktadır.



RAIN

KARE

BAHN



**HM-31359**

Style koku tutucu kullanılmaktadır.

**SIMPLE DELUXE**

Ürün Kodu	Kısa Kod	Çıkış	Ölçü		Fiyat
<b>ALT ÇIKIŞ</b>					
4061.0A050K.020.1	29728	Ø 50	20 cm	12	283.40
4061.0A050K.030.1	29730	Ø 50	30 cm	12	360.00
4061.0A050K.040.1	28916	Ø 50	40 cm	12	440.00
4061.0A050K.050.1	28917	Ø 50	50 cm	12	516.70
4061.0A050K.060.1	28918	Ø 50	60 cm	12	596.70

Duş kanalı / W200-330-400-500-600-800 mm / Ø 50 yan - alt çıkış  
Paslanmaz gövde / Paslanmaz ızgara / Sulu koku tutucu

**DELUXE**

Ürün Kodu	Kısa Kod	Çıkış	Ölçü		Fiyat
<b>YAN ÇIKIŞ</b>					
4061.0Y050K.020.1	29727	Ø 50	20 cm	12	330.00
4061.0Y050K.030.1	29729	Ø 50	30 cm	12	410.00
4061.0Y050K.040.1	28922	Ø 50	40 cm	12	490.00
4061.0Y050K.050.1	28923	Ø 50	50 cm	12	570.00
4061.0Y050K.060.1	28924	Ø 50	60 cm	12	653.40

**ALT ÇIKIŞ**

4065.0A050K.020.1	31377	Ø 50	20 cm	12	330.00
4065.0A050K.030.1	31378	Ø 50	30 cm	12	410.00
4065.0A050K.040.1	31379	Ø 50	40 cm	12	490.00
4065.0A050K.050.1	31380	Ø 50	50 cm	12	570.00
4065.0A050K.060.1	31381	Ø 50	60 cm	12	653.40

Duş kanalı / W200-330-400-500-600-800 mm / Ø 50 yan - alt çıkış  
Paslanmaz gövde / Paslanmaz ızgara / Sulu koku tutucu



**HM-31359**

Style koku tutucu kullanılmaktadır.

**DELUXE Y360°**

Ürün Kodu	Kısa Kod	Çıkış	Ölçü		Fiyat
<b>YAN ÇIKIŞ</b>					
4066.0Y050K.020.1	30020	Ø 50	20 cm	12	386.70
4066.0Y050K.030.1	30021	Ø 50	30 cm	12	463.40
4066.0Y050K.040.1	30022	Ø 50	40 cm	12	543.40
4066.0Y050K.050.1	30023	Ø 50	50 cm	12	626.70
4066.0Y050K.060.1	30024	Ø 50	60 cm	12	703.40

**ALT ÇIKIŞ**

4066.0A050K.020.1	30766	Ø 50	20 cm	12	386.70
4066.0A050K.030.1	30767	Ø 50	30 cm	12	463.40
4066.0A050K.040.1	30768	Ø 50	40 cm	12	543.40
4066.0A050K.050.1	30769	Ø 50	50 cm	12	626.70
4066.0A050K.060.1	30770	Ø 50	60 cm	12	703.40

Duş kanalı / W200-330-400-500-600-800 mm / Ø 50 yan - alt çıkış  
Paslanmaz gövde / Paslanmaz ızgara / Sulu koku tutucu



**HM-31359**

Style koku tutucu kullanılmaktadır.



RAİN



KARE



BAHN



# PERA SERİSİ

**MAXIFLOW**  
Maksimum akış...

## LINE

Ürün Kodu	Kısa Kod	Çıkış	Ölçü		Fiyat
<b>YAN ÇIKIŞ</b>					
3152.0Y050K.033.1	26499	Ø 50	30 cm	12	213.40
3152.0Y050K.040.1	26500	Ø 50	40 cm	12	250.00
3152.0Y050K.050.1	26501	Ø 50	50 cm	12	283.40
3152.0Y050K.060.1	26502	Ø 50	60 cm	12	313.40
3152.0Y050K.080.1	26503	Ø 50	80 cm	12	373.40
<b>ALT ÇIKIŞ</b>					
3152.0A050K.033.1	26494	Ø 50	30 cm	12	213.40
3152.0A050K.040.1	26495	Ø 50	40 cm	12	250.00
3152.0A050K.050.1	26496	Ø 50	50 cm	12	283.40
3152.0A050K.060.1	26497	Ø 50	60 cm	12	313.40
3152.0A050K.080.1	26498	Ø 50	80 cm	12	373.40

Duş kanalı / W200-330-400-500-600-800 mm / Ø 50 yan - alt çıkış  
Plastik gövde / Paslanmaz ızgara / Sulu koku tutucu



**HM-27970**

Pera koku tutucu kullanılmaktadır.

## LINE

Ürün Kodu	Kısa Kod	Çıkış	Ölçü		Fiyat
<b>YAN ÇIKIŞ</b>					
3153.0Y050K.033.1	26509	Ø 50	30 cm	12	213.40
3153.0Y050K.040.1	26510	Ø 50	40 cm	12	250.00
3153.0Y050K.050.1	26511	Ø 50	50 cm	12	283.40
3153.0Y050K.060.1	26512	Ø 50	60 cm	12	313.40
3153.0Y050K.080.1	26513	Ø 50	80 cm	12	373.40
<b>ALT ÇIKIŞ</b>					
3153.0A050K.033.1	26504	Ø 50	30 cm	12	213.40
3153.0A050K.040.1	26505	Ø 50	40 cm	12	250.00
3153.0A050K.050.1	26506	Ø 50	50 cm	12	283.40
3153.0A050K.060.1	26507	Ø 50	60 cm	12	313.40
3153.0A050K.080.1	26508	Ø 50	80 cm	12	373.40

Duş kanalı / W200-330-400-500-600-800 mm / Ø 50 yan - alt çıkış  
Plastik gövde / Paslanmaz ızgara / Sulu koku tutucu



**HM-27970**

Pera koku tutucu kullanılmaktadır.

## LINE

Ürün Kodu	Kısa Kod	Çıkış	Ölçü		Fiyat
<b>YAN ÇIKIŞ</b>					
3154.0Y050K.033.1	26519	Ø 50	30 cm	12	213.40
3154.0Y050K.040.1	26520	Ø 50	40 cm	12	250.00
3154.0Y050K.050.1	26521	Ø 50	50 cm	12	283.40
3154.0Y050K.060.1	26522	Ø 50	60 cm	12	313.40
3154.0Y050K.080.1	26523	Ø 50	80 cm	12	373.40
<b>ALT ÇIKIŞ</b>					
3154.0A050K.033.1	26514	Ø 50	30 cm	12	213.40
3154.0A050K.040.1	26515	Ø 50	40 cm	12	250.00
3154.0A050K.050.1	26516	Ø 50	50 cm	12	283.40
3154.0A050K.060.1	26517	Ø 50	60 cm	12	313.40
3154.0A050K.080.1	26518	Ø 50	80 cm	12	373.40

Duş kanalı / W200-330-400-500-600-800 mm / Ø 50 yan - alt çıkış  
Plastik gövde / Paslanmaz ızgara / Sulu koku tutucu



**HM-27970**

Pera koku tutucu kullanılmaktadır.

**LINE Y360°**



**HM-27970**

Pera koku tutucu kullanılmaktadır.



**HM-27970**

Pera koku tutucu kullanılmaktadır.



**HM-27970**

Pera koku tutucu kullanılmaktadır.

Ürün Kodu	Kısa Kod	Çıkış	Ölçü		Fiyat
<b>YAN ÇIKIŞ</b>					
3150.0Y050K.033.1	30097	Ø 50	30 cm	12	266.70
3150.0Y050K.040.1	30098	Ø 50	40 cm	12	306.70
3150.0Y050K.050.1	30099	Ø 50	50 cm	12	346.70
3150.0Y050K.060.1	30100	Ø 50	60 cm	12	373.40
3150.0Y050K.080.1	30101	Ø 50	80 cm	12	436.70
<b>ALT ÇIKIŞ</b>					
3150.0A050K.033.1	30102	Ø 50	30 cm	12	266.70
3150.0A050K.040.1	30103	Ø 50	40 cm	12	306.70
3150.0A050K.050.1	30104	Ø 50	50 cm	12	346.70
3150.0A050K.060.1	30105	Ø 50	60 cm	12	373.40
3150.0A050K.080.1	30106	Ø 50	80 cm	12	436.70

Duş kanalı / W200-330-400-500-600-800 mm / Ø 50 yan - alt çıkış  
Plastik gövde / Paslanmaz ızgara / Sulu koku tutucu

**LINE Y360°**

Ürün Kodu	Kısa Kod	Çıkış	Ölçü		Fiyat
<b>YAN ÇIKIŞ</b>					
3151.0Y050K.033.1	30107	Ø 50	30 cm	12	266.70
3151.0Y050K.040.1	30108	Ø 50	40 cm	12	306.70
3151.0Y050K.050.1	30109	Ø 50	50 cm	12	346.70
3151.0Y050K.060.1	30110	Ø 50	60 cm	12	373.40
3151.0Y050K.080.1	30111	Ø 50	80 cm	12	436.70
<b>ALT ÇIKIŞ</b>					
3151.0A050K.033.1	30112	Ø 50	30 cm	12	266.70
3151.0A050K.040.1	30113	Ø 50	40 cm	12	306.70
3151.0A050K.050.1	30114	Ø 50	50 cm	12	346.70
3151.0A050K.060.1	30115	Ø 50	60 cm	12	373.40
3151.0A050K.080.1	30116	Ø 50	80 cm	12	436.70

Duş kanalı / W200-330-400-500-600-800 mm / Ø 50 yan - alt çıkış  
Plastik gövde / Paslanmaz ızgara / Sulu koku tutucu

**LINE Y360°**

Ürün Kodu	Kısa Kod	Çıkış	Ölçü		Fiyat
<b>YAN ÇIKIŞ</b>					
3149.0Y050K.033.1	30117	Ø 50	30 cm	12	266.70
3149.0Y050K.040.1	30118	Ø 50	40 cm	12	306.70
3149.0Y050K.050.1	30119	Ø 50	50 cm	12	346.70
3149.0Y050K.060.1	30120	Ø 50	60 cm	12	373.40
3149.0Y050K.080.1	30121	Ø 50	80 cm	12	436.70
<b>ALT ÇIKIŞ</b>					
3149.0A050K.033.1	30122	Ø 50	30 cm	12	266.70
3149.0A050K.040.1	30123	Ø 50	40 cm	12	306.70
3149.0A050K.050.1	30124	Ø 50	50 cm	12	346.70
3149.0A050K.060.1	30125	Ø 50	60 cm	12	373.40
3149.0A050K.080.1	30126	Ø 50	80 cm	12	436.70

Duş kanalı / W200-330-400-500-600-800 mm / Ø 50 yan - alt çıkış  
Plastik gövde / Paslanmaz ızgara / Sulu koku tutucu

LINE

Ürün Kodu	Kısa Kod	Çıkış	Ölçü		Fiyat
<b>YAN ÇIKIŞ</b>					
3155.0Y050K.033.1	26529	Ø 50	30 cm	12	243.40
3155.0Y050K.040.1	26530	Ø 50	40 cm	12	290.00
3155.0Y050K.050.1	26531	Ø 50	50 cm	12	330.00
3155.0Y050K.060.1	26532	Ø 50	60 cm	12	366.70
3155.0Y050K.080.1	26533	Ø 50	80 cm	12	436.70
<b>ALT ÇIKIŞ</b>					
3155.0A050K.033.1	26524	Ø 50	30 cm	12	243.40
3155.0A050K.040.1	26525	Ø 50	40 cm	12	290.00
3155.0A050K.050.1	26526	Ø 50	50 cm	12	330.00
3155.0A050K.060.1	26527	Ø 50	60 cm	12	366.70
3155.0A050K.080.1	26528	Ø 50	80 cm	12	436.70

Duş kanalı / W200-330-400-500-600-800 mm / Ø 50 yan - alt çıkış  
Plastik gövde / Paslanmaz ızgara / Sulu koku tutucu



HM-27970

Pera koku tutucu kullanılmaktadır.

LINE

Ürün Kodu	Kısa Kod	Çıkış	Ölçü		Fiyat
<b>YAN ÇIKIŞ</b>					
3156.0Y050K.033.1	26549	Ø 50	30 cm	12	243.40
3156.0Y050K.040.1	26550	Ø 50	40 cm	12	290.00
3156.0Y050K.050.1	26551	Ø 50	50 cm	12	330.00
3156.0Y050K.060.1	26552	Ø 50	60 cm	12	366.70
3156.0Y050K.080.1	26553	Ø 50	80 cm	12	436.70
<b>ALT ÇIKIŞ</b>					
3156.0A050K.033.1	26544	Ø 50	30 cm	12	243.40
3156.0A050K.040.1	26545	Ø 50	40 cm	12	290.00
3156.0A050K.050.1	26546	Ø 50	50 cm	12	330.00
3156.0A050K.060.1	26547	Ø 50	60 cm	12	366.70
3156.0A050K.080.1	26548	Ø 50	80 cm	12	436.70

Duş kanalı / W200-330-400-500-600-800 mm / Ø 50 yan - alt çıkış  
Plastik gövde / Paslanmaz ızgara / Sulu koku tutucu



HM-27970

Pera koku tutucu kullanılmaktadır.

LINE

Ürün Kodu	Kısa Kod	Çıkış	Ölçü		Fiyat
<b>YAN ÇIKIŞ</b>					
3157.0Y050K.033.1	26569	Ø 50	30 cm	12	243.40
3157.0Y050K.040.1	26570	Ø 50	40 cm	12	290.00
3157.0Y050K.050.1	26571	Ø 50	50 cm	12	330.00
3157.0Y050K.060.1	26572	Ø 50	60 cm	12	366.70
3157.0Y050K.080.1	26575	Ø 50	80 cm	12	436.70
<b>ALT ÇIKIŞ</b>					
3157.0A050K.033.1	26564	Ø 50	30 cm	12	243.40
3157.0A050K.040.1	26565	Ø 50	40 cm	12	290.00
3157.0A050K.050.1	26566	Ø 50	50 cm	12	330.00
3157.0A050K.060.1	26567	Ø 50	60 cm	12	366.70
3157.0A050K.080.1	26568	Ø 50	80 cm	12	436.70

Duş kanalı / W200-330-400-500-600-800 mm / Ø 50 yan - alt çıkış  
Plastik gövde / Paslanmaz ızgara / Sulu koku tutucu

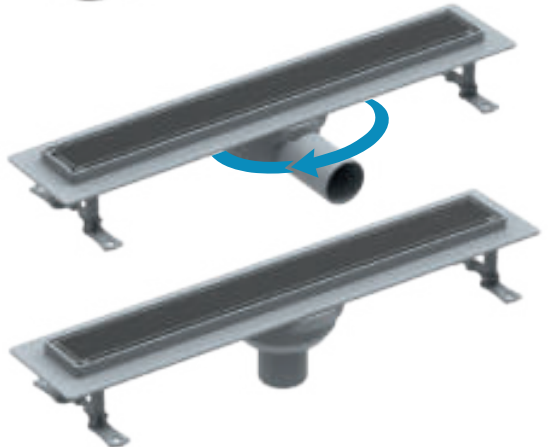

HM-27970

Pera koku tutucu kullanılmaktadır.



**HM-27970**  
Pera koku tutucu kullanılmaktadır.



**HM-27970**  
Pera koku tutucu kullanılmaktadır.



**HM-27970**  
Pera koku tutucu kullanılmaktadır.

**LINE Y360°**

Ürün Kodu	Kısa Kod	Çıkış	Ölçü		Fiyat
<b>YAN ÇIKIŞ</b>					
3148.0Y050K.033.1	30127	Ø 50	30 cm	12	300.00
3148.0Y050K.040.1	30128	Ø 50	40 cm	12	350.00
3148.0Y050K.050.1	30129	Ø 50	50 cm	12	393.40
3148.0Y050K.060.1	30130	Ø 50	60 cm	12	430.00
3148.0Y050K.080.1	30131	Ø 50	80 cm	12	503.40
<b>ALT ÇIKIŞ</b>					
3148.0A050K.033.1	30132	Ø 50	30 cm	12	300.00
3148.0A050K.040.1	30133	Ø 50	40 cm	12	350.00
3148.0A050K.050.1	30134	Ø 50	50 cm	12	393.40
3148.0A050K.060.1	30135	Ø 50	60 cm	12	430.00
3148.0A050K.080.1	30136	Ø 50	80 cm	12	503.40

Duş kanalı / W200-330-400-500-600-800 mm / Ø 50 yan - alt çıkış  
Plastik gövde / Paslanmaz ızgara / Sulu koku tutucu

**LINE Y360°**

Ürün Kodu	Kısa Kod	Çıkış	Ölçü		Fiyat
<b>YAN ÇIKIŞ</b>					
3146.0Y050K.033.1	30147	Ø 50	30 cm	12	300.00
3146.0Y050K.040.1	30148	Ø 50	40 cm	12	350.00
3146.0Y050K.050.1	30149	Ø 50	50 cm	12	393.40
3146.0Y050K.060.1	30150	Ø 50	60 cm	12	430.00
3146.0Y050K.080.1	30151	Ø 50	80 cm	12	503.40
<b>ALT ÇIKIŞ</b>					
3146.0A050K.033.1	30152	Ø 50	30 cm	12	300.00
3146.0A050K.040.1	30153	Ø 50	40 cm	12	350.00
3146.0A050K.050.1	30154	Ø 50	50 cm	12	393.40
3146.0A050K.060.1	30155	Ø 50	60 cm	12	430.00
3146.0A050K.080.1	30156	Ø 50	80 cm	12	503.40

Duş kanalı / W200-330-400-500-600-800 mm / Ø 50 yan - alt çıkış  
Plastik gövde / Paslanmaz ızgara / Sulu koku tutucu

**LINE Y360°**

Ürün Kodu	Kısa Kod	Çıkış	Ölçü		Fiyat
<b>YAN ÇIKIŞ</b>					
3160.0Y050K.033.1	30157	Ø 50	30 cm	12	300.00
3160.0Y050K.040.1	30158	Ø 50	40 cm	12	350.00
3160.0Y050K.050.1	30159	Ø 50	50 cm	12	393.40
3160.0Y050K.060.1	30160	Ø 50	60 cm	12	430.00
3160.0Y050K.080.1	30161	Ø 50	80 cm	12	503.40
<b>ALT ÇIKIŞ</b>					
3160.0A050K.033.1	30162	Ø 50	30 cm	12	300.00
3160.0A050K.040.1	30163	Ø 50	40 cm	12	350.00
3160.0A050K.050.1	30164	Ø 50	50 cm	12	393.40
3160.0A050K.060.1	30165	Ø 50	60 cm	12	430.00
3160.0A050K.080.1	30166	Ø 50	80 cm	12	503.40

Duş kanalı / W200-330-400-500-600-800 mm / Ø 50 yan - alt çıkış  
Plastik gövde / Paslanmaz ızgara / Sulu koku tutucu

## LINE T.M.

Ürün Kodu	Kısa Kod	Çıkış	Ölçü		Fiyat
<b>YAN ÇIKIŞ</b>					
3155.TY050K.033.1	26539	Ø 50	30 cm	12	296.70
3155.TY050K.040.1	26540	Ø 50	40 cm	12	353.40
3155.TY050K.050.1	26541	Ø 50	50 cm	12	403.40
3155.TY050K.060.1	26542	Ø 50	60 cm	12	446.70
3155.TY050K.080.1	26543	Ø 50	80 cm	12	530.00
<b>ALT ÇIKIŞ</b>					
3155.TA050K.033.1	26534	Ø 50	30 cm	12	296.70
3155.TA050K.040.1	26535	Ø 50	40 cm	12	353.40
3155.TA050K.050.1	26536	Ø 50	50 cm	12	403.40
3155.TA050K.060.1	26537	Ø 50	60 cm	12	446.70
3155.TA050K.080.1	26538	Ø 50	80 cm	12	530.00

Duş kanalı / W200-330-400-500-600-800 mm / Ø 50 yan - alt çıkış  
Plastik gövde / Paslanmaz ızgara / Sulu koku tutucu



HM-27970

Pera koku tutucu kullanılmaktadır.

## LINE T.M.

Ürün Kodu	Kısa Kod	Çıkış	Ölçü		Fiyat
<b>YAN ÇIKIŞ</b>					
3156.TY050K.033.1	26559	Ø 50	30 cm	12	296.70
3156.TY050K.040.1	26560	Ø 50	40 cm	12	353.40
3156.TY050K.050.1	26561	Ø 50	50 cm	12	403.40
3156.TY050K.060.1	26562	Ø 50	60 cm	12	446.70
3156.TY050K.080.1	26563	Ø 50	80 cm	12	530.00
<b>ALT ÇIKIŞ</b>					
3156.TA050K.033.1	26554	Ø 50	30 cm	12	296.70
3156.TA050K.040.1	26555	Ø 50	40 cm	12	353.40
3156.TA050K.050.1	26556	Ø 50	50 cm	12	403.40
3156.TA050K.060.1	26557	Ø 50	60 cm	12	446.70
3156.TA050K.080.1	26558	Ø 50	80 cm	12	530.00

Duş kanalı / W200-330-400-500-600-800 mm / Ø 50 yan - alt çıkış  
Plastik gövde / Paslanmaz ızgara / Sulu koku tutucu



HM-27970

Pera koku tutucu kullanılmaktadır.

## LINE T.M.

Ürün Kodu	Kısa Kod	Çıkış	Ölçü		Fiyat
<b>YAN ÇIKIŞ</b>					
3157.TY050K.033.1	26581	Ø 50	30 cm	12	296.70
3157.TY050K.040.1	26582	Ø 50	40 cm	12	353.40
3157.TY050K.050.1	26584	Ø 50	50 cm	12	403.40
3157.TY050K.060.1	26585	Ø 50	60 cm	12	446.70
3157.TY050K.080.1	26586	Ø 50	80 cm	12	530.00
<b>ALT ÇIKIŞ</b>					
3157.TA050K.033.1	26576	Ø 50	30 cm	12	296.70
3157.TA050K.040.1	26577	Ø 50	40 cm	12	353.40
3157.TA050K.050.1	26578	Ø 50	50 cm	12	403.40
3157.TA050K.060.1	26579	Ø 50	60 cm	12	446.70
3157.TA050K.080.1	26580	Ø 50	80 cm	12	530.00

Duş kanalı / W200-330-400-500-600-800 mm / Ø 50 yan - alt çıkış  
Plastik gövde / Paslanmaz ızgara / Sulu koku tutucu



HM-27970

Pera koku tutucu kullanılmaktadır.

**LINE T.M. Y360°**



**HM-27970**

Pera koku tutucu kullanılmaktadır.

Ürün Kodu	Kısa Kod	Çıkış	Ölçü		Fiyat
<b>YAN ÇIKIŞ</b>					
3168.TY050K.033.1	30207	Ø 50	30 cm	12	343.40
3168.TY050K.040.1	30208	Ø 50	40 cm	12	400.00
3168.TY050K.050.1	30209	Ø 50	50 cm	12	453.40
3168.TY050K.060.1	30210	Ø 50	60 cm	12	500.00
3168.TY050K.080.1	30211	Ø 50	80 cm	12	586.70
<b>ALT ÇIKIŞ</b>					
3168.TA050K.033.1	30212	Ø 50	30 cm	12	343.40
3168.TA050K.040.1	30213	Ø 50	40 cm	12	400.00
3168.TA050K.050.1	30214	Ø 50	50 cm	12	453.40
3168.TA050K.060.1	30215	Ø 50	60 cm	12	500.00
3168.TA050K.080.1	30216	Ø 50	80 cm	12	586.70

Duş kanalı / W200-330-400-500-600-800 mm / Ø 50 yan - alt çıkış  
Plastik gövde / Paslanmaz ızgara / Sulu koku tutucu

**LINE T.M. Y360°**



**HM-27970**

Pera koku tutucu kullanılmaktadır.

Ürün Kodu	Kısa Kod	Çıkış	Ölçü		Fiyat
<b>YAN ÇIKIŞ</b>					
3169.TY050K.033.1	30217	Ø 50	30 cm	12	343.40
3169.TY050K.040.1	30218	Ø 50	40 cm	12	400.00
3169.TY050K.050.1	30219	Ø 50	50 cm	12	453.40
3169.TY050K.060.1	30220	Ø 50	60 cm	12	500.00
3169.TY050K.080.1	30221	Ø 50	80 cm	12	586.70
<b>ALT ÇIKIŞ</b>					
3169.TA050K.033.1	30222	Ø 50	30 cm	12	343.40
3169.TA050K.040.1	30223	Ø 50	40 cm	12	400.00
3169.TA050K.050.1	30224	Ø 50	50 cm	12	453.40
3169.TA050K.060.1	30225	Ø 50	60 cm	12	500.00
3169.TA050K.080.1	30226	Ø 50	80 cm	12	586.70

Duş kanalı / W200-330-400-500-600-800 mm / Ø 50 yan - alt çıkış  
Plastik gövde / Paslanmaz ızgara / Sulu koku tutucu

**LINE T.M. Y360°**



**HM-27970**

Pera koku tutucu kullanılmaktadır.

Ürün Kodu	Kısa Kod	Çıkış	Ölçü		Fiyat
<b>YAN ÇIKIŞ</b>					
3170.TY050K.033.1	30227	Ø 50	30 cm	12	343.40
3170.TY050K.040.1	30228	Ø 50	40 cm	12	400.00
3170.TY050K.050.1	30229	Ø 50	50 cm	12	453.40
3170.TY050K.060.1	30230	Ø 50	60 cm	12	500.00
3170.TY050K.080.1	30231	Ø 50	80 cm	12	586.70
<b>ALT ÇIKIŞ</b>					
3170.TA050K.033.1	30232	Ø 50	30 cm	12	343.40
3170.TA050K.040.1	30233	Ø 50	40 cm	12	400.00
3170.TA050K.050.1	30234	Ø 50	50 cm	12	453.40
3170.TA050K.060.1	30235	Ø 50	60 cm	12	500.00
3170.TA050K.080.1	30236	Ø 50	80 cm	12	586.70

Duş kanalı / W200-330-400-500-600-800 mm / Ø 50 yan - alt çıkış  
Plastik gövde / Paslanmaz ızgara / Sulu koku tutucu

# PERA SERİSİ

**MAXIFLOW**  
Maksimum akış...

## LEGAL

Ürün Kodu	Kısa Kod	Çıkış	Ölçü		Fiyat
<b>YAN ÇIKIŞ</b>					
3158.0Y050K.033.1	26595	Ø 50	30 cm	12	370.00
3158.0Y050K.040.1	26596	Ø 50	40 cm	12	450.00
3158.0Y050K.050.1	26597	Ø 50	50 cm	12	550.00
3158.0Y050K.060.1	26598	Ø 50	60 cm	12	613.40
3158.0Y050K.080.1	26599	Ø 50	80 cm	12	740.00
<b>ALT ÇIKIŞ</b>					
3158.0A050K.033.1	26587	Ø 50	30 cm	12	370.00
3158.0A050K.040.1	26588	Ø 50	40 cm	12	450.00
3158.0A050K.050.1	26592	Ø 50	50 cm	12	550.00
3158.0A050K.060.1	26593	Ø 50	60 cm	12	613.40
3158.0A050K.080.1	26594	Ø 50	80 cm	12	740.00

Duş kanalı / W200-330-400-500-600-800 mm / Ø 50 yan - alt çıkış  
Paslanmaz gövde / Paslanmaz ızgara / Sulu koku tutucu



**HM-27970**

Pera koku tutucu kullanılmaktadır.

## LEGAL

Ürün Kodu	Kısa Kod	Çıkış	Ölçü		Fiyat
<b>YAN ÇIKIŞ</b>					
3159.0Y050K.033.1	26615	Ø 50	30 cm	12	370.00
3159.0Y050K.040.1	26616	Ø 50	40 cm	12	450.00
3159.0Y050K.050.1	26617	Ø 50	50 cm	12	550.00
3159.0Y050K.060.1	26618	Ø 50	60 cm	12	613.40
3159.0Y050K.080.1	26619	Ø 50	80 cm	12	740.00
<b>ALT ÇIKIŞ</b>					
3159.0A050K.033.1	26610	Ø 50	30 cm	12	370.00
3159.0A050K.040.1	26611	Ø 50	40 cm	12	450.00
3159.0A050K.050.1	26612	Ø 50	50 cm	12	550.00
3159.0A050K.060.1	26613	Ø 50	60 cm	12	613.40
3159.0A050K.080.1	26614	Ø 50	80 cm	12	740.00

Duş kanalı / W200-330-400-500-600-800 mm / Ø 50 yan - alt çıkış  
Paslanmaz gövde / Paslanmaz ızgara / Sulu koku tutucu



**HM-27970**

Pera koku tutucu kullanılmaktadır.

## DELUXE

Ürün Kodu	Kısa Kod	Çıkış	Ölçü		Fiyat
<b>YAN ÇIKIŞ</b>					
3163.0Y050K.033.1	28952	Ø 50	30 cm	12	430.00
3163.0Y050K.040.1	28953	Ø 50	40 cm	12	493.40
3163.0Y050K.050.1	28954	Ø 50	50 cm	12	563.40
3163.0Y050K.060.1	28955	Ø 50	60 cm	12	640.00
3163.0Y050K.080.1	28956	Ø 50	80 cm	12	776.70
<b>ALT ÇIKIŞ</b>					
3163.0A050K.033.1	28957	Ø 50	30 cm	12	430.00
3163.0A050K.040.1	28958	Ø 50	40 cm	12	493.40
3163.0A050K.050.1	28959	Ø 50	50 cm	12	563.40
3163.0A050K.060.1	28960	Ø 50	60 cm	12	640.00
3163.0A050K.080.1	28961	Ø 50	80 cm	12	776.70

Duş kanalı / W200-330-400-500-600-800 mm / Ø 50 yan - alt çıkış  
Paslanmaz gövde / Paslanmaz ızgara / Sulu koku tutucu



**HM-27970**

Pera koku tutucu kullanılmaktadır.

**LEGAL Y360°**



**HM-27970**

Pera koku tutucu kullanılmaktadır.

Ürün Kodu	Kısa Kod	Çıkış	Ölçü		Fiyat
<b>YAN ÇIKIŞ</b>					
3161.0Y050K.033.1	30167	Ø 50	30 cm	12	433.40
3161.0Y050K.040.1	30168	Ø 50	40 cm	12	516.70
3161.0Y050K.050.1	30169	Ø 50	50 cm	12	623.40
3161.0Y050K.060.1	30170	Ø 50	60 cm	12	690.00
3161.0Y050K.080.1	30171	Ø 50	80 cm	12	823.40
<b>ALT ÇIKIŞ</b>					
3161.0A050K.033.1	30172	Ø 50	30 cm	12	433.40
3161.0A050K.040.1	30173	Ø 50	40 cm	12	516.70
3161.0A050K.050.1	30174	Ø 50	50 cm	12	623.40
3161.0A050K.060.1	30175	Ø 50	60 cm	12	690.00
3161.0A050K.080.1	30176	Ø 50	80 cm	12	823.40

Duş kanalı / W200-330-400-500-600-800 mm / Ø 50 yan - alt çıkış  
Paslanmaz gövde / Paslanmaz ızgara / Sulu koku tutucu

**LEGAL Y360°**



**HM-27970**

Pera koku tutucu kullanılmaktadır.

Ürün Kodu	Kısa Kod	Çıkış	Ölçü		Fiyat
<b>YAN ÇIKIŞ</b>					
3167.0Y050K.033.1	30197	Ø 50	30 cm	12	433.40
3167.0Y050K.040.1	30198	Ø 50	40 cm	12	516.70
3167.0Y050K.050.1	30199	Ø 50	50 cm	12	623.40
3167.0Y050K.060.1	30200	Ø 50	60 cm	12	690.00
3167.0Y050K.080.1	30201	Ø 50	80 cm	12	823.40
<b>ALT ÇIKIŞ</b>					
3167.0A050K.033.1	30202	Ø 50	30 cm	12	433.40
3167.0A050K.040.1	30203	Ø 50	40 cm	12	516.70
3167.0A050K.050.1	30204	Ø 50	50 cm	12	623.40
3167.0A050K.060.1	30205	Ø 50	60 cm	12	690.00
3167.0A050K.080.1	30206	Ø 50	80 cm	12	823.40

Duş kanalı / W200-330-400-500-600-800 mm / Ø 50 yan - alt çıkış  
Paslanmaz gövde / Paslanmaz ızgara / Sulu koku tutucu

**DELUXE Y360°**



**HM-27970**

Pera koku tutucu kullanılmaktadır.

Ürün Kodu	Kısa Kod	Çıkış	Ölçü		Fiyat
<b>YAN ÇIKIŞ</b>					
3164.0Y050K.033.1	30177	Ø 50	30 cm	12	483.40
3164.0Y050K.040.1	30178	Ø 50	40 cm	12	546.70
3164.0Y050K.050.1	30179	Ø 50	50 cm	12	620.00
3164.0Y050K.060.1	30180	Ø 50	60 cm	12	696.70
3164.0Y050K.080.1	30181	Ø 50	80 cm	12	836.70
<b>ALT ÇIKIŞ</b>					
3164.0A050K.033.1	30182	Ø 50	30 cm	12	483.40
3164.0A050K.040.1	30183	Ø 50	40 cm	12	546.70
3164.0A050K.050.1	30184	Ø 50	50 cm	12	620.00
3164.0A050K.060.1	30185	Ø 50	60 cm	12	696.70
3164.0A050K.080.1	30186	Ø 50	80 cm	12	836.70

Duş kanalı / W200-330-400-500-600-800 mm / Ø 50 yan - alt çıkış  
Paslanmaz gövde / Paslanmaz ızgara / Sulu koku tutucu



LEGAL T.M.

Ürün Kodu	Kısa Kod	Çıkış	Ölçü		Fiyat
<b>YAN ÇIKIŞ</b>					
3158.TY050K.033.1	26604	Ø 50	30 cm	12	416.70
3158.TY050K.040.1	26605	Ø 50	40 cm	12	503.40
3158.TY050K.050.1	26606	Ø 50	50 cm	12	606.70
3158.TY050K.060.1	26607	Ø 50	60 cm	12	676.70
3158.TY050K.080.1	26608	Ø 50	80 cm	12	810.00
<b>ALT ÇIKIŞ</b>					
3158.TA050K.033.1	26609	Ø 50	30 cm	12	416.70
3158.TA050K.040.1	26600	Ø 50	40 cm	12	503.40
3158.TA050K.050.1	26601	Ø 50	50 cm	12	606.70
3158.TA050K.060.1	26602	Ø 50	60 cm	12	676.70
3158.TA050K.080.1	26603	Ø 50	80 cm	12	810.00

Duş kanalı / W200-330-400-500-600-800 mm / Ø 50 yan - alt çıkış  
Paslanmaz gövde / Paslanmaz ızgara / Sulu koku tutucu

LEGAL T.M.

Ürün Kodu	Kısa Kod	Çıkış	Ölçü		Fiyat
<b>YAN ÇIKIŞ</b>					
3159.TY050K.033.1	26625	Ø 50	30 cm	12	416.70
3159.TY050K.040.1	26626	Ø 50	40 cm	12	503.40
3159.TY050K.050.1	26627	Ø 50	50 cm	12	606.70
3159.TY050K.060.1	26628	Ø 50	60 cm	12	676.70
3159.TY050K.080.1	26629	Ø 50	80 cm	12	810.00
<b>ALT ÇIKIŞ</b>					
3159.TA050K.033.1	26620	Ø 50	30 cm	12	416.70
3159.TA050K.040.1	26621	Ø 50	40 cm	12	503.40
3159.TA050K.050.1	26622	Ø 50	50 cm	12	606.70
3159.TA050K.060.1	26623	Ø 50	60 cm	12	676.70
3159.TA050K.080.1	26624	Ø 50	80 cm	12	810.00

Duş kanalı / W200-330-400-500-600-800 mm / Ø 50 yan - alt çıkış  
Paslanmaz gövde / Paslanmaz ızgara / Sulu koku tutucu

LINE FİLELİ

Ürün Kodu	Kısa Kod	Çıkış	Ölçü		Fiyat
<b>YAN ÇIKIŞ</b>					
3155.FY050K.033.1	27366	Ø 50	30 cm	12	260.00
3155.FY050K.040.1	27367	Ø 50	40 cm	12	320.00
3155.FY050K.050.1	27368	Ø 50	50 cm	12	356.70
3155.FY050K.060.1	37369	Ø 50	60 cm	12	396.70
3155.FY050K.080.1	37370	Ø 50	80 cm	12	466.70
<b>ALT ÇIKIŞ</b>					
3155.FA050K.033.1	27371	Ø 50	30 cm	12	260.00
3155.FA050K.040.1	37372	Ø 50	40 cm	12	320.00
3155.FA050K.050.1	37373	Ø 50	50 cm	12	356.70
3155.FA050K.060.1	37374	Ø 50	60 cm	12	396.70
3155.FA050K.080.1	37375	Ø 50	80 cm	12	466.70

Duş kanalı / W200-330-400-500-600-800 mm / Ø 50 yan - alt çıkış  
Paslanmaz gövde / Paslanmaz ızgara / Sulu koku tutucu

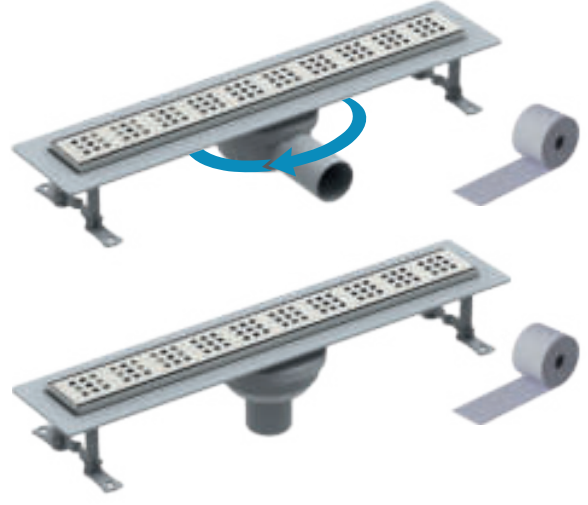

HM-27970

Pera koku tutucu kullanılmaktadır.

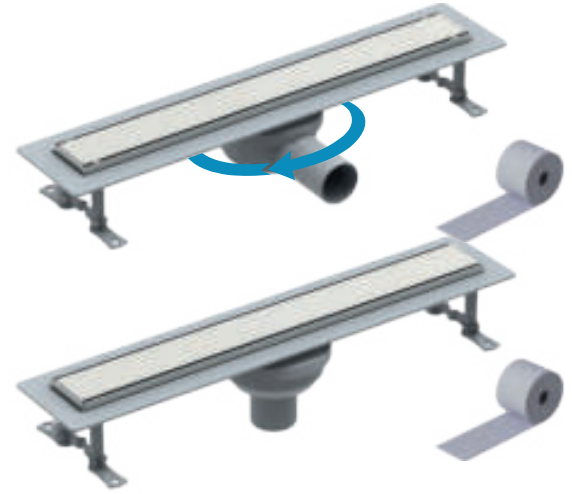

HM-27970

Pera koku tutucu kullanılmaktadır.



HM-27970

Pera koku tutucu kullanılmaktadır.

**LEGAL T.M.Y360°**



**HM-27970**

Pera koku tutucu kullanılmaktadır.

Ürün Kodu	Kısa Kod	Çıkış	Ölçü		Fiyat
<b>YAN ÇIKIŞ</b>					
3171.TY050K.033.1	30237	Ø 50	30 cm	12	480.00
3171.TY050K.040.1	30238	Ø 50	40 cm	12	573.35
3171.TY050K.050.1	30239	Ø 50	50 cm	12	683.40
3171.TY050K.060.1	30240	Ø 50	60 cm	12	756.70
3171.TY050K.080.1	30241	Ø 50	80 cm	12	896.70
<b>ALT ÇIKIŞ</b>					
3171.TA050K.033.1	30242	Ø 50	30 cm	12	480.00
3171.TA050K.040.1	30243	Ø 50	40 cm	12	573.35
3171.TA050K.050.1	30244	Ø 50	50 cm	12	683.40
3171.TA050K.060.1	30245	Ø 50	60 cm	12	756.70
3171.TA050K.080.1	30246	Ø 50	80 cm	12	896.70

Duş kanalı / W200-330-400-500-600-800 mm / Ø 50 yan - alt çıkış  
Paslanmaz gövde / Paslanmaz ızgara / Sulu koku tutucu

**LEGAL T.M. Y360°**



**HM-27970**

Pera koku tutucu kullanılmaktadır.

Ürün Kodu	Kısa Kod	Çıkış	Ölçü		Fiyat
<b>YAN ÇIKIŞ</b>					
3172.TY050K.033.1	30247	Ø 50	30 cm	12	480.00
3172.TY050K.040.1	30248	Ø 50	40 cm	12	573.40
3172.TY050K.050.1	30249	Ø 50	50 cm	12	683.40
3172.TY050K.060.1	30250	Ø 50	60 cm	12	756.70
3172.TY050K.080.1	30251	Ø 50	80 cm	12	896.70
<b>ALT ÇIKIŞ</b>					
3172.TA050K.033.1	30252	Ø 50	30 cm	12	480.00
3172.TA050K.040.1	30253	Ø 50	40 cm	12	573.40
3172.TA050K.050.1	30254	Ø 50	50 cm	12	683.40
3172.TA050K.060.1	30255	Ø 50	60 cm	12	756.70
3172.TA050K.080.1	30256	Ø 50	80 cm	12	896.70

Duş kanalı / W200-330-400-500-600-800 mm / Ø 50 yan - alt çıkış  
Paslanmaz gövde / Paslanmaz ızgara / Sulu koku tutucu

**LINE FİLELİ Y360°**



**HM-27970**

Pera koku tutucu kullanılmaktadır.

Ürün Kodu	Kısa Kod	Çıkış	Ölçü		Fiyat
<b>YAN ÇIKIŞ</b>					
3147.FY050K.033.1	30137	Ø 50	30 cm	12	313.40
3147.FY050K.040.1	30138	Ø 50	40 cm	12	376.70
3147.FY050K.050.1	30139	Ø 50	50 cm	12	413.40
3147.FY050K.060.1	30140	Ø 50	60 cm	12	456.70
3147.FY050K.080.1	30141	Ø 50	80 cm	12	526.70
<b>ALT ÇIKIŞ</b>					
3147.FA050K.033.1	30142	Ø 50	30 cm	12	313.40
3147.FA050K.040.1	30143	Ø 50	40 cm	12	376.70
3147.FA050K.050.1	30144	Ø 50	50 cm	12	413.40
3147.FA050K.060.1	30145	Ø 50	60 cm	12	456.70
3147.FA050K.080.1	30146	Ø 50	80 cm	12	526.70

Duş kanalı / W200-330-400-500-600-800 mm / Ø 50 yan - alt çıkış  
Paslanmaz gövde / Paslanmaz ızgara / Sulu koku tutucu

## LINE

Ürün Kodu	Kısa Kod	Çıkış	Ölçü		Fiyat
<b>ALÇAK SEVİYELİ YAN ÇIKIŞ</b>					
4022.0Y050A.033.1	22310	Ø 50	33 cm	12	290.00
4022.0Y050A.040.1	22382	Ø 50	40 cm	12	333.40
4022.0Y050A.050.1	22391	Ø 50	50 cm	12	383.40
4022.0Y050A.060.1	22400	Ø 50	60 cm	12	473.40
4022.0Y050A.080.1	22409	Ø 50	80 cm	12	513.40
<b>ALÇAK SEVİYELİ ALT ÇIKIŞ</b>					
4022.0A050A.033.1	22418	Ø 50	33 cm	12	290.00
4022.0A050A.040.1	22426	Ø 50	40 cm	12	333.40
4022.0A050A.050.1	22435	Ø 50	50 cm	12	383.40
4022.0A050A.060.1	22446	Ø 50	60 cm	12	473.40
4022.0A050A.080.1	22459	Ø 50	80 cm	12	513.40

Duş kanalı / W200-330-400-500-600 mm / Ø 50 yan - alt çıkış  
Plastik gövde / Paslanmaz ızgara / Sulu koku tutucu

## LINE

Ürün Kodu	Kısa Kod	Çıkış	Ölçü		Fiyat
<b>YAN ÇIKIŞ</b>					
4022.0Y050K.033.1	16126	Ø 50	30 cm	12	290.00
4022.0Y050K.040.1	16138	Ø 50	40 cm	12	333.40
4022.0Y050K.050.1	16157	Ø 50	50 cm	12	383.40
4022.0Y050K.060.1	16168	Ø 50	60 cm	12	473.40
4022.0Y050K.080.1	16178	Ø 50	80 cm	12	513.40
<b>ALT ÇIKIŞ</b>					
4022.0A050K.033.1	16159	Ø 50	30 cm	12	290.00
4022.0A050K.040.1	16187	Ø 50	40 cm	12	333.40
4022.0A050K.050.1	16207	Ø 50	50 cm	12	383.40
4022.0A050K.060.1	16231	Ø 50	60 cm	12	473.40
4022.0A050K.080.1	16249	Ø 50	80 cm	12	513.40

Duş kanalı / W200-330-400-500-600-800 mm / Ø 50 yan - alt çıkış  
Plastik gövde / Paslanmaz ızgara / Sulu koku tutucu

## LINE T.M.

Ürün Kodu	Kısa Kod	Çıkış	Ölçü		Fiyat
<b>YAN ÇIKIŞ</b>					
4022.TY050K.033.1	16268	Ø 50	33 cm	12	316.70
4022.TY050K.040.1	16283	Ø 50	40 cm	12	346.70
4022.TY050K.050.1	16298	Ø 50	50 cm	12	386.70
4022.TY050K.060.1	16312	Ø 50	60 cm	12	463.40
4022.TY050K.080.1	16332	Ø 50	80 cm	12	503.40
<b>ALT ÇIKIŞ</b>					
4022.TA050K.033.1	16363	Ø 50	33 cm	12	316.70
4022.TA050K.040.1	16395	Ø 50	40 cm	12	346.70
4022.TA050K.050.1	16413	Ø 50	50 cm	12	386.70
4022.TA050K.060.1	16436	Ø 50	60 cm	12	463.40
4022.TA050K.080.1	16451	Ø 50	80 cm	12	503.40

Duş kanalı / W200-330-400-500-600-800 mm / Ø 50 yan - alt çıkış  
Plastik gövde / Paslanmaz ızgara / Sulu koku tutucu



**HM-31362**

Kısa koku tutucu kullanılmaktadır.



**HM-31361**

Uzun koku tutucu kullanılmaktadır.

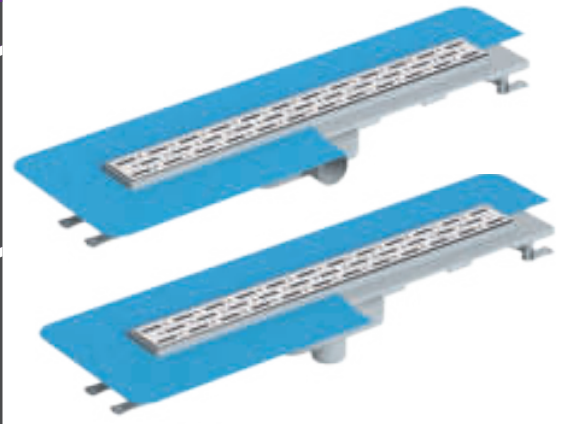

**HM-31361**

Uzun koku tutucu kullanılmaktadır.



**RAIN**



**KARE**



**BAHN**



**DOLU**



**HM-31361**

Uzun koku tutucu kullanılmaktadır.



**HM-31361**

Uzun koku tutucu kullanılmaktadır.

PARÇANO	PARÇA AÇIKLAMASI	MALZEME	ADET
4016.1	Plastik Alt Gövde	ABS	1
4016.2	Koku Tutucu	ABS	1
4016.3	Paslanmaz Izgara	AISI 304	1
4016.4	Yükseklik Ayarlı Montaj Seti	PP	2

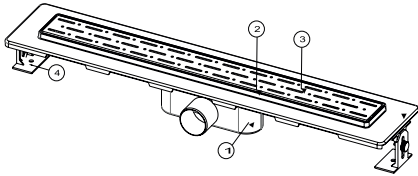

ÜRÜN KODU	W	L	H	Ø D	A	B	C	X	E	B1	A1
4016.0Y050K.033.1	423	134	72	49.5	360	88.9	11.35	385	1	56	325
4016.0Y050K.040.1	492	134	72	49.5	430	88.9	11.35	456	1	56	395
4016.0Y050K.050.1	592	134	72	49.5	530	88.9	11.35	556	1.5	56	495
4016.0Y050K.060.1	693	134	72	49.5	630	88.9	11.35	656	1.5	56	595
4016.0Y050K.080.1	893	134	72	49.5	830	88.9	11.35	856	1.5	56	795

ÜRÜN KODU	W	L	H	Ø D	A	B	C	X	E	B1	A1
4016.0A050K.033.1	423	134	100	49.5	360	88.9	11.35	385	1	56	325
4016.0A050K.040.1	492	134	100	49.5	430	88.9	11.35	456	1	56	395
4016.0A050K.050.1	592	134	100	49.5	530	88.9	11.35	556	1.5	56	495
4016.0A050K.060.1	693	134	100	49.5	630	88.9	11.35	656	1.5	56	595
4016.0A050K.080.1	893	134	100	49.5	830	88.9	11.35	856	1.5	56	795

Tablo ölçü birimi "mm"dir.

**DELUXE**

Ürün Kodu	Kısa Kod	Çıkış	Ölçü		Fiyat
<b>YAN ÇIKIŞ</b>					
4016.0Y050K.033.1	16462	Ø 50	33 cm	12	443.40
4016.0Y050K.040.1	16486	Ø 50	40 cm	12	483.40
4016.0Y050K.050.1	16497	Ø 50	50 cm	12	560.00
4016.0Y050K.060.1	16512	Ø 50	60 cm	12	643.40
4016.0Y050K.080.1	16527	Ø 50	80 cm	12	796.70
<b>ALT ÇIKIŞ</b>					
4016.0A050K.033.1	16542	Ø 50	33 cm	12	443.40
4016.0A050K.040.1	16570	Ø 50	40 cm	12	483.40
4016.0A050K.050.1	16592	Ø 50	50 cm	12	560.00
4016.0A050K.060.1	16608	Ø 50	60 cm	12	643.40
4016.0A050K.080.1	16625	Ø 50	80 cm	12	796.70

Duş kanalı / W200-330-400-500-600 mm / Ø 50 yan - alt çıkış  
Plastik gövde / Paslanmaz ızgara ve çerçeve / Sulu koku tutucu

**DELUXE T.M.**

Ürün Kodu	Kısa Kod	Çıkış	Ölçü		Fiyat
<b>YAN ÇIKIŞ</b>					
4016.TY050K.033.1	16555	Ø 50	30 cm	12	473.40
4016.TY050K.040.1	16572	Ø 50	40 cm	12	536.70
4016.TY050K.050.1	16587	Ø 50	50 cm	12	616.70
4016.TY050K.060.1	16604	Ø 50	60 cm	12	690.00
4016.TY050K.080.1	16634	Ø 50	80 cm	12	853.40
<b>ALT ÇIKIŞ</b>					
4016.TA050K.033.1	16643	Ø 50	30 cm	12	473.40
4016.TA050K.040.1	16666	Ø 50	40 cm	12	536.70
4016.TA050K.050.1	16683	Ø 50	50 cm	12	616.70
4016.TA050K.060.1	16704	Ø 50	60 cm	12	690.00
4016.TA050K.080.1	16722	Ø 50	80 cm	12	853.40

Duş kanalı / W200-330-400-500-600 mm / Ø 50 yan - alt çıkış  
Plastik gövde / Paslanmaz ızgara ve çerçeve / Sulu koku tutucu

**Detaylar**

DN 50 Yan ve Alt çıkış – Pvc boru bağlantılarına uyumludur. Akış hızı 32 lt/dk'dır. Izgarası 304 kalite paslanmaz çeliktir.

**Avantajlar**

304 kalite paslanmaz çelik ızgarası sayesinde şık ve kaliteli bir görünüme sahiptir. Duvar dibi uygulamalarda rahatlıkla uygulanabilir. Su tutuculu koku önleyici sayesinde tesisattan gelecek kötü kokuları önler. Yükseltme ayakları sayesinde şapın yüksekliğine göre ayarlama olanağı sağlar. Organik ve inorganik kimyasallara yüksek dayanım. çoğu asidik ve tuzlu su oksidasyonuna dayanıklıdır.

**Kullanım Alanları**

Genel kullanım banyo duşları. hastane ve otel duş alanları. soyunma odaları duş alanları vb.

**Özel Üretim**

Izgara modeli olarak isteğinize göre altın, bronz gibi renkler de üretilmektedir.

**Uyarı**

Yüksek yoğunluklu temizlik malzemelerinin uzun süreli kullanımı tavsiye edilmez.

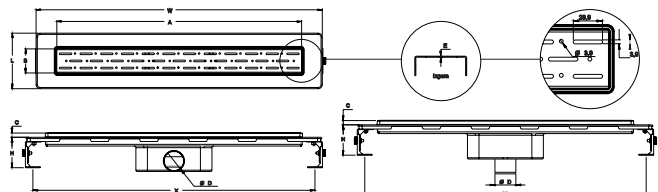

## LINE

Ürün Kodu	Kısa Kod	Çıkış	Ölçü		Fiyat
<b>YAN ÇIKIŞ</b>					
4023.0Y050K.033.1	16648	Ø 50	33 cm	12	290.00
4023.0Y050K.040.1	16669	Ø 50	40 cm	12	336.70
4023.0Y050K.050.1	16689	Ø 50	50 cm	12	390.00
4023.0Y050K.060.1	16705	Ø 50	60 cm	12	446.70
4023.0Y050K.080.1	18687	Ø 50	80 cm	12	560.00
<b>ALT ÇIKIŞ</b>					
4023.0A050K.033.1	16723	Ø 50	33 cm	12	290.00
4023.0A050K.040.1	16742	Ø 50	40 cm	12	336.70
4023.0A050K.050.1	16755	Ø 50	50 cm	12	390.00
4023.0A050K.060.1	16769	Ø 50	60 cm	12	446.70
4023.0A050K.080.1	18720	Ø 50	80 cm	12	560.00

Duş kanalı / W200-330-400-500-600-800 mm / Ø 50 yan - alt çıkış  
Plastik gövde / Paslanmaz ızgara / Sulu koku tutucu

## LINE T.M.

Ürün Kodu	Kısa Kod	Çıkış	Ölçü		Fiyat
<b>YAN ÇIKIŞ</b>					
4023.TY050K.033.1	16739	Ø 50	33 cm	12	366.70
4023.TY050K.040.1	16768	Ø 50	40 cm	12	416.70
4023.TY050K.050.1	16783	Ø 50	50 cm	12	476.70
4023.TY050K.060.1	16800	Ø 50	60 cm	12	536.70
4023.TY050K.080.1	18739	Ø 50	80 cm	12	663.40
<b>ALT ÇIKIŞ</b>					
4023.TA050K.033.1	16791	Ø 50	33 cm	12	366.70
4023.TA050K.040.1	16805	Ø 50	40 cm	12	416.70
4023.TA050K.050.1	16818	Ø 50	50 cm	12	476.70
4023.TA050K.060.1	16832	Ø 50	60 cm	12	536.70
4023.TA050K.080.1	18763	Ø 50	80 cm	12	663.40

Duş kanalı / W200-330-400-500-600-800 mm / Ø 50 yan - alt çıkış  
Plastik gövde / Paslanmaz ızgara / Sulu koku tutucu

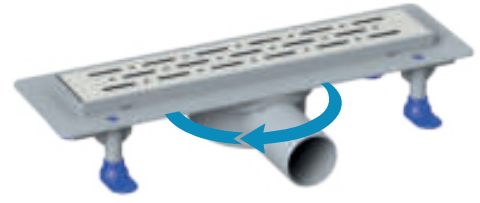

**HM-31360**

Prime koku tutucu kullanılmaktadır.

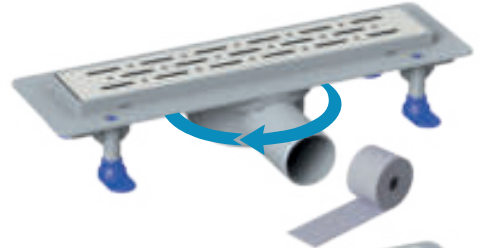

**HM-31360**

Prime koku tutucu kullanılmaktadır.





**HM-31360**

Prime koku tutucu kullanılmaktadır.

**LINE Y360°**

Ürün Kodu	Kısa Kod	Çıkış	Ölçü	Fiyat
<b>YAN ÇIKIŞ</b>				
4020.0Y050K.033.1	30257	Ø 50	33 cm	12
4020.0Y050K.040.1	30261	Ø 50	40 cm	12
4020.0Y050K.050.1	30265	Ø 50	50 cm	12
4020.0Y050K.060.1	30269	Ø 50	60 cm	12
4020.0Y050K.080.1	30273	Ø 50	80 cm	12
<b>ALT ÇIKIŞ</b>				
4020.0A050K.033.1	30277	Ø 50	33 cm	12
4020.0A050K.040.1	30281	Ø 50	40 cm	12
4020.0A050K.050.1	30285	Ø 50	50 cm	12
4020.0A050K.060.1	30289	Ø 50	60 cm	12
4020.0A050K.080.1	30293	Ø 50	80 cm	12

Duş kanalı / W200-330-400-500-600-800 mm / Ø 50 yan - alt çıkış  
Plastik gövde / Paslanmaz ızgara / Sulu koku tutucu

**LINE T.M. Y360°**

Ürün Kodu	Kısa Kod	Çıkış	Ölçü	Fiyat
<b>YAN ÇIKIŞ</b>				
4020.TY050K.033.1	30297	Ø 50	33 cm	12
4020.TY050K.040.1	30301	Ø 50	40 cm	12
4020.TY050K.050.1	30305	Ø 50	50 cm	12
4020.TY050K.060.1	30309	Ø 50	60 cm	12
4020.TY050K.080.1	30313	Ø 50	80 cm	12
<b>ALT ÇIKIŞ</b>				
4020.TA050K.033.1	30317	Ø 50	33 cm	12
4020.TA050K.040.1	30321	Ø 50	40 cm	12
4020.TA050K.050.1	30325	Ø 50	50 cm	12
4020.TA050K.060.1	30329	Ø 50	60 cm	12
4020.TA050K.080.1	30333	Ø 50	80 cm	12

Duş kanalı / W200-330-400-500-600-800 mm / Ø 50 yan - alt çıkış  
Plastik gövde / Paslanmaz ızgara / Sulu koku tutucu



**HM-31360**

Prime koku tutucu kullanılmaktadır.

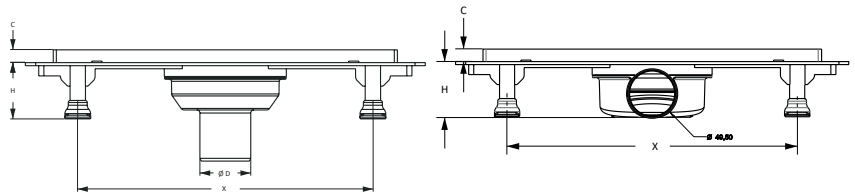
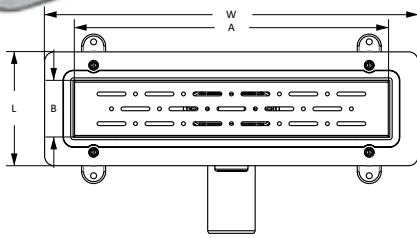

	W	L	H	ØD	A	B	C	X	E
4023.0Y050K.033.1	389	119	55	50	335	64.5	12.5	287	1.2
4023.0Y050K.040.1	454	119	55	50	405	64.5	12.5	387	1.2
4023.0Y050K.050.1	554	119	55	50	505	64.5	12.5	487	1.2
4023.0Y050K.060.1	654	119	55	50	605	64.5	12.5	587	1.2
4023.0Y050K.080.1	854	119	55	50	805	64.5	12.5	787	1.2

	W	L	H	ØD	A	B	C	X	E
4023.0A050K.033.1	389	119	55	50	335	64.5	12.5	287	1.2
4023.0A050K.040.1	454	119	55	50	405	64.5	12.5	387	1.2
4023.0A050K.050.1	554	119	55	50	505	64.5	12.5	487	1.2
4023.0A050K.060.1	654	119	55	50	605	64.5	12.5	587	1.2
4023.0A050K.080.1	854	119	55	50	805	64.5	12.5	787	1.2

Tablo ölçü birimi "mm"dir.

**Detaylar**

DN 50 Yan ve Alt çıkış – Pvc boru bağlantılarına uyumludur. Akış hızı 32 lt/dk'dır. Izgarası 304 kalite paslanmaz çeliktir.

**Avantajlar**

304 kalite paslanmaz çelik ızgarası sayesinde şık ve kaliteli bir görünüme sahiptir. Duvar dibi uygulamalarda rahatlıkla uygulanabilir. Su tutuculu koku önleyici sayesinde tesisattan gelecek kötü kokuları önler. Yükseltme ayakları sayesinde şapın yüksekliğine göre ayarlama olanağı sağlar. Organik ve inorganik kimyasallara yüksek dayanım. çoğu asidik ve tuzlu su oksidasyonuna dayanıklıdır.

**Kullanım Alanları**

Genel kullanım banyo duşları, hastane ve otel duş alanları, soyunma odaları duş alanları vb.

**Özel Üretim**

Izgara modeli olarak isteğinize göre altın, bronz gibi renklerde üretilmektedir.

**Uyarı**

Yüksek yoğunluklu temizlik malzemelerinin uzun süreli kullanımı tavsiye edilmez.

LEGAL

Ürün Kodu	Kısa Kod	Çıkış	Ölçü		Fiyat
<b>YAN ÇIKIŞ</b>					
4024.0Y050K.033.1	16842	Ø 50	33 cm	12	373.40
4024.0Y050K.040.1	16857	Ø 50	40 cm	12	420.00
4024.0Y050K.050.1	16880	Ø 50	50 cm	12	486.70
4024.0Y050K.060.1	16902	Ø 50	60 cm	12	550.00
4024.0Y050K.080.1	18723	Ø 50	80 cm	12	686.70
<b>ALT ÇIKIŞ</b>					
4024.0A050K.033.1	16841	Ø 50	33 cm	12	373.40
4024.0A050K.040.1	16860	Ø 50	40 cm	12	420.00
4024.0A050K.050.1	16876	Ø 50	50 cm	12	486.70
4024.0A050K.060.1	16892	Ø 50	60 cm	12	550.00
4024.0A050K.080.1	18740	Ø 50	80 cm	12	686.70

Duş kanalı / W200-330-400-500-600-800 mm / Ø 50 yan - alt çıkış  
Plastik gövde / Paslanmaz çerçeve ve ızgara / Sulu koku tutucu

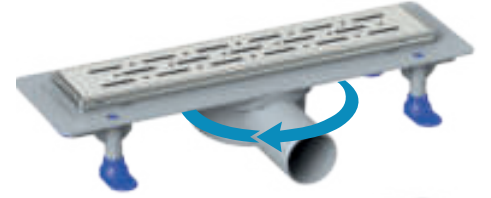

**HM-31360**  
Prime koku tutucu kullanılmaktadır.

LEGAL T.M.

Ürün Kodu	Kısa Kod	Çıkış	Ölçü		Fiyat
<b>YAN ÇIKIŞ</b>					
4024.TY050K.033.1	16922	Ø 50	33 cm	12	440.00
4024.TY050K.040.1	16940	Ø 50	40 cm	12	496.70
4024.TY050K.050.1	16951	Ø 50	50 cm	12	573.40
4024.TY050K.060.1	16968	Ø 50	60 cm	12	646.70
4024.TY050K.080.1	18754	Ø 50	80 cm	12	800.00
<b>ALT ÇIKIŞ</b>					
4024.TA050K.033.1	16915	Ø 50	33 cm	12	440.00
4024.TA050K.040.1	16941	Ø 50	40 cm	12	496.70
4024.TA050K.050.1	16967	Ø 50	50 cm	12	573.40
4024.TA050K.060.1	16986	Ø 50	60 cm	12	646.70
4024.TA050K.080.1	18770	Ø 50	80 cm	12	800.00

Duş kanalı / W200-330-400-500-600-800 mm / Ø 50 yan - alt çıkış  
Plastik gövde / Paslanmaz çerçeve ve ızgara / Sulu koku tutucu

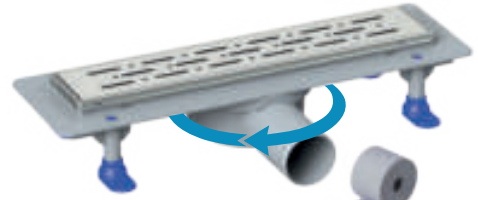

**HM-31360**  
Prime koku tutucu kullanılmaktadır.

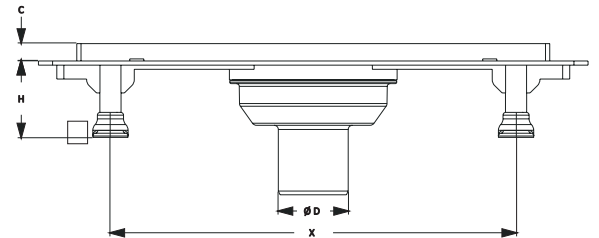
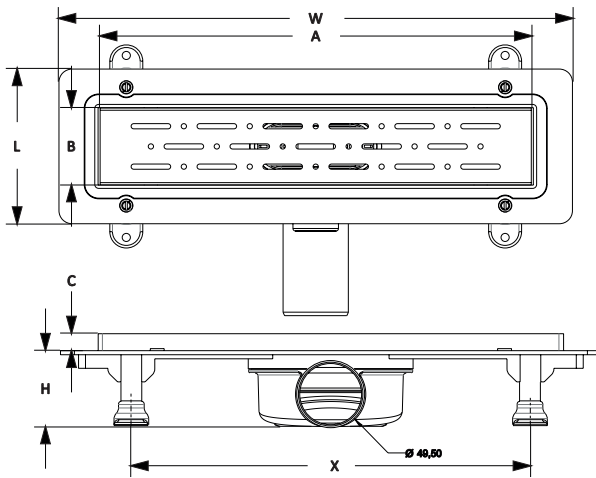

	W	L	H	Ø D	A	B	C	X	E
4024.0A050K.033.1	389	119	55	50	335	64.5	12.5	287	1.2
4024.0A050K.040.1	454	119	55	50	405	64.5	12.5	387	1.2
4024.0A050K.050.1	554	119	55	50	505	64.5	12.5	487	1.2
4024.0A050K.060.1	654	119	55	50	605	64.5	12.5	587	1.2

	W	L	H	Ø D	A	B	C	X	E
4024.0Y050K.033.1	389	119	55	50	335	64.5	12.5	287	1.2
4024.0Y050K.040.1	454	119	55	50	405	64.5	12.5	387	1.2
4024.0Y050K.050.1	554	119	55	50	505	64.5	12.5	487	1.2
4024.0Y050K.060.1	654	119	55	50	605	64.5	12.5	587	1.2

Tablo ölçü birimi "mm"dir.

**LEGAL Y360°**



**HM-31360**

Prime koku tutucu kullanılmaktadır.

Ürün Kodu	Kısa Kod	Çıkış	Ölçü	Fiyat	
<b>YAN ÇIKIŞ</b>					
4021.0Y050K.033.1	30337	Ø 50	33 cm	12	410.00
4021.0Y050K.040.1	30341	Ø 50	40 cm	12	460.00
4021.0Y050K.050.1	30345	Ø 50	50 cm	12	523.40
4021.0Y050K.060.1	30349	Ø 50	60 cm	12	586.70
4021.0Y050K.080.1	30353	Ø 50	80 cm	12	726.70
<b>ALT ÇIKIŞ</b>					
4021.0A050K.033.1	30357	Ø 50	33 cm	12	410.00
4021.0A050K.040.1	30361	Ø 50	40 cm	12	460.00
4021.0A050K.050.1	30365	Ø 50	50 cm	12	523.40
4021.0A050K.060.1	30369	Ø 50	60 cm	12	586.70
4021.0A050K.080.1	30373	Ø 50	80 cm	12	726.70

Duş kanalı / W200-330-400-500-600-800 mm / Ø 50 yan - alt çıkış  
Plastik gövde / Paslanmaz çerçeve ve ızgara / Sulu koku tutucu

**LEGAL T.M. Y360°**



**HM-31360**

Prime koku tutucu kullanılmaktadır.

Ürün Kodu	Kısa Kod	Çıkış	Ölçü	Fiyat	
<b>YAN ÇIKIŞ</b>					
4021.TY050K.033.1	30377	Ø 50	33 cm	12	480.00
4021.TY050K.040.1	30381	Ø 50	40 cm	12	536.70
4021.TY050K.050.1	30385	Ø 50	50 cm	12	613.40
4021.TY050K.060.1	30389	Ø 50	60 cm	12	686.70
4021.TY050K.080.1	30393	Ø 50	80 cm	12	836.70
<b>ALT ÇIKIŞ</b>					
4021.TA050K.033.1	30397	Ø 50	33 cm	12	480.00
4021.TA050K.040.1	30401	Ø 50	40 cm	12	536.70
4021.TA050K.050.1	30405	Ø 50	50 cm	12	613.40
4021.TA050K.060.1	30409	Ø 50	60 cm	12	686.70
4021.TA050K.080.1	30413	Ø 50	80 cm	12	836.70

Duş kanalı / W200-330-400-500-600-800 mm / Ø 50 yan - alt çıkış  
Plastik gövde / Paslanmaz çerçeve ve ızgara / Sulu koku tutucu

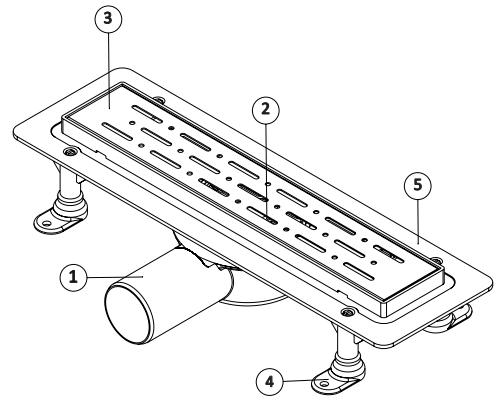

PARÇA NO	PARÇA AÇIKLAMASI	MALZEME	ADET
4023.1	Plastik Alt Gövde	ABS	1
4023.2	Koku Tutucu	ABS	1
4023.3	Paslanmaz Izgara	AISI 304	1
4023.4	Yükseklik Ayarlı Montaj Seti	PP	4
4023.5	Plastik Üst Gövde	PP	1





## DELUXE

Ürün Kodu	Kısa Kod	Çıkış	Ölçü		Fiyat
<b>YAN ÇIKIŞ</b>					
4025.0Y050K.033.1	16978	Ø 50	33 cm	12	443.40
4025.0Y050K.040.1	17003	Ø 50	40 cm	12	506.70
4025.0Y050K.050.1	17031	Ø 50	50 cm	12	580.00
4025.0Y050K.060.1	17041	Ø 50	60 cm	12	666.70
4025.0Y050K.080.1	18784	Ø 50	80 cm	12	833.40
<b>ALT ÇIKIŞ</b>					
4025.0A050K.033.1	17004	Ø 50	33 cm	12	443.40
4025.0A050K.040.1	17018	Ø 50	40 cm	12	506.70
4025.0A050K.050.1	17030	Ø 50	50 cm	12	580.00
4025.0A050K.060.1	17071	Ø 50	60 cm	12	666.70
4025.0A050K.080.1	18795	Ø 50	80 cm	12	833.40

Duş kanalı / W200-330-400-500-600-800 mm / Ø 50 yan - alt çıkış  
Plastik gövde / Paslanmaz çerçeve ve ızgara / Sulu koku tutucu



HM-31360

Prime koku tutucu kullanılmaktadır.

## DELUXE T.M.

Ürün Kodu	Kısa Kod	Çıkış	Ölçü		Fiyat
<b>YAN ÇIKIŞ</b>					
4025.TY050K.033.1	17050	Ø 50	33 cm	12	493.40
4025.TY050K.040.1	17059	Ø 50	40 cm	12	560.00
4025.TY050K.050.1	17081	Ø 50	50 cm	12	643.40
4025.TY050K.060.1	17098	Ø 50	60 cm	12	736.70
4025.TY050K.080.1	18792	Ø 50	80 cm	12	913.40
<b>ALT ÇIKIŞ</b>					
4025.TA050K.033.1	17085	Ø 50	33 cm	12	493.40
4025.TA050K.040.1	17130	Ø 50	40 cm	12	560.00
4025.TA050K.050.1	17145	Ø 50	50 cm	12	643.40
4025.TA050K.060.1	17160	Ø 50	60 cm	12	736.70
4025.TA050K.080.1	18815	Ø 50	80 cm	12	913.40

Duş kanalı / W200-330-400-500-600-800 mm / Ø 50 yan - alt çıkış  
Plastik gövde / Paslanmaz çerçeve ve ızgara / Sulu koku tutucu

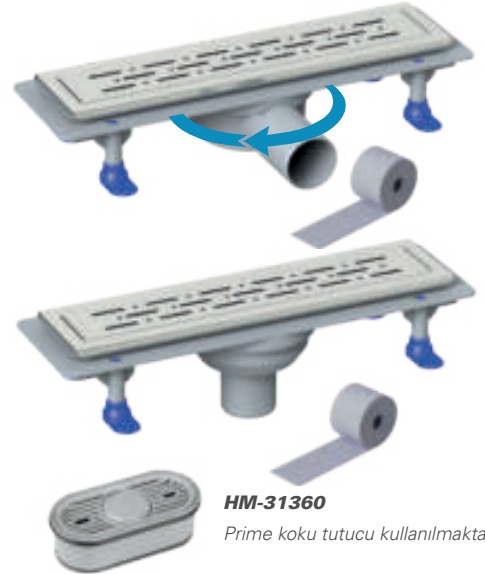

HM-31360

Prime koku tutucu kullanılmaktadır.



**DELUXE Y360°**



**HM-31360**

Prime koku tutucu kullanılmaktadır.

Ürün Kodu	Kısa Kod	Çıkış	Ölçü		Fiyat
<b>YAN ÇIKIŞ</b>					
4029.0Y050K.033.1	30417	Ø 50	33 cm	12	480.00
4029.0Y050K.040.1	30421	Ø 50	40 cm	12	540.00
4029.0Y050K.050.1	30425	Ø 50	50 cm	12	616.70
4029.0Y050K.060.1	30429	Ø 50	60 cm	12	703.40
4029.0Y050K.080.1	30433	Ø 50	80 cm	12	870.00
<b>ALT ÇIKIŞ</b>					
4029.0A050K.033.1	30437	Ø 50	33 cm	12	480.00
4029.0A050K.040.1	30441	Ø 50	40 cm	12	540.00
4029.0A050K.050.1	30445	Ø 50	50 cm	12	616.70
4029.0A050K.060.1	30449	Ø 50	60 cm	12	703.40
4029.0A050K.080.1	30453	Ø 50	80 cm	12	870.00

Duş kanalı / W200-330-400-500-600-800 mm / Ø 50 yan - alt çıkış  
Plastik gövde / Paslanmaz çerçeve ve ızgara / Sulu koku tutucu

**DELUXE T.M. Y360°**



**HM-31360**

Prime koku tutucu kullanılmaktadır.

Ürün Kodu	Kısa Kod	Çıkış	Ölçü		Fiyat
<b>YAN ÇIKIŞ</b>					
4029.TY050K.033.1	30457	Ø 50	33 cm	12	530.00
4029.TY050K.040.1	30461	Ø 50	40 cm	12	596.70
4029.TY050K.050.1	30465	Ø 50	50 cm	12	680.00
4029.TY050K.060.1	30469	Ø 50	60 cm	12	773.40
4029.TY050K.080.1	30473	Ø 50	80 cm	12	946.70
<b>ALT ÇIKIŞ</b>					
4029.TA050K.033.1	30477	Ø 50	33 cm	12	530.00
4029.TA050K.040.1	30481	Ø 50	40 cm	12	596.70
4029.TA050K.050.1	30485	Ø 50	50 cm	12	680.00
4029.TA050K.060.1	30489	Ø 50	60 cm	12	773.40
4029.TA050K.080.1	30493	Ø 50	80 cm	12	946.70

Duş kanalı / W200-330-400-500-600-800 mm / Ø 50 yan - alt çıkış  
Plastik gövde / Paslanmaz çerçeve ve ızgara / Sulu koku tutucu

**Detaylar**

DN 50 Yan ve Alt çıkış – Pvc boru bağlantılarına uyumlu. sulu tip (36mm) koku önleyiciye sahiptir. Akış hızı 32 lt/dk'dır. Dış kimyasal etkilere dayanım çalışma sıcaklığı -30°+75° arasındır. Izgarası 304 kalite paslanmaz çeliktir.

**Avantajlar**

304 kalite paslanmaz çelik ızgarası sayesinde şık ve kaliteli bir görünüme sahiptir. Duvar dibi uygulamalarda rahatlıkla uygulanabilir. Su tutuculu koku önleyici sayesinde tesisattan gelecek kötü kokuları önler. Yükseltme ayakları sayesinde şapın yüksekliğine göre ayarlama olanakları sağlar. Organik ve inorganik kimyasallara yüksek dayanım, çoğu asidik ve tuzlu su oksidasyonuna dayanıklıdır.

**Kullanım Alanları**

Genel kullanım banyo duşları, hastane ve otel duş alanları, soyunma odaları duş alanları vb.

**Özel Üretim**

Izgara modeli olarak istediğinize göre altın, bronz gibi renkler de üretilmektedir.

**Uyarı**

Yüksek yoğunluklu temizlik malzemelerinin uzun süreli kullanımı tavsiye edilmez.

	W	L	H	ØD	A	B	C	X	E
4028.0Y050K.033.1	389	119	55	50	335	64.5	12.5	287	1.2
4028.0Y050K.040.1	454	119	55	50	405	64.5	12.5	387	1.2
4028.0Y050K.050.1	554	119	55	50	505	64.5	12.5	487	1.2
4028.0Y050K.060.1	654	119	55	50	605	64.5	12.5	587	1.2

	W	L	H	ØD	A	B	C	X	E
4028.0A050K.033.1	389	119	55	50	335	64.5	12.5	287	1.2
4028.0A050K.040.1	454	119	55	50	405	64.5	12.5	387	1.2
4028.0A050K.050.1	554	119	55	50	505	64.5	12.5	487	1.2
4028.0A050K.060.1	654	119	55	50	605	64.5	12.5	587	1.2

Tablo ölçü birimi "mm"dir.

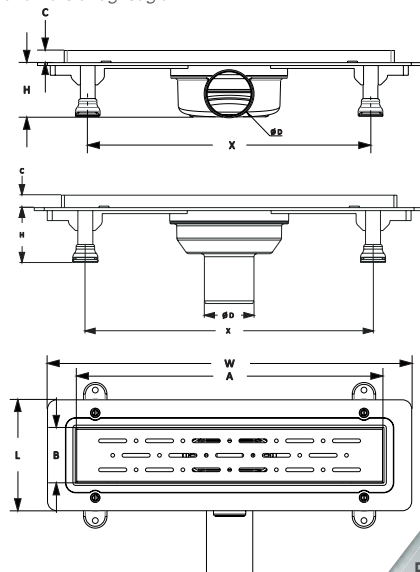

SCALA

Ürün Kodu	Kısa Kod	Çıkış	Ölçü		Fiyat
<b>YAN ÇIKIŞ</b>					
4026.0Y050K.033.1	17107	Ø 50	33 cm	12	283.40
4026.0Y050K.040.1	17108	Ø 50	40 cm	12	326.70
4026.0Y050K.050.1	17109	Ø 50	50 cm	12	370.00
4026.0Y050K.060.1	17110	Ø 50	60 cm	12	420.00
4026.0Y050K.080.1	18806	Ø 50	80 cm	12	530.00
<b>ALT ÇIKIŞ</b>					
4026.0A050K.033.1	17111	Ø 50	33 cm	12	283.40
4026.0A050K.040.1	17112	Ø 50	40 cm	12	326.70
4026.0A050K.050.1	17113	Ø 50	50 cm	12	370.00
4026.0A050K.060.1	17114	Ø 50	60 cm	12	420.00
4026.0A050K.080.1	18810	Ø 50	80 cm	12	530.00

Duş kanalı / W200-330-400-500-600-800 mm / Ø 50 yan - alt çıkış  
Plastik gövde / Paslanmaz ızgara / Sulu koku tutucu



HM-31360

Prime koku tutucu kullanılmaktadır.

SCALA T.M.

Ürün Kodu	Kısa Kod	Çıkış	Ölçü		Fiyat
<b>YAN ÇIKIŞ</b>					
4026.TY050K.033.1	17115	Ø 50	33 cm	12	333.40
4026.TY050K.040.1	17116	Ø 50	40 cm	12	380.00
4026.TY050K.050.1	17117	Ø 50	50 cm	12	433.40
4026.TY050K.060.1	17118	Ø 50	60 cm	12	490.00
4026.TY050K.080.1	18813	Ø 50	80 cm	12	606.70
<b>ALT ÇIKIŞ</b>					
4026.TA050K.033.1	17119	Ø 50	33 cm	12	333.40
4026.TA050K.040.1	17120	Ø 50	40 cm	12	380.00
4026.TA050K.050.1	17121	Ø 50	50 cm	12	433.40
4026.TA050K.060.1	17122	Ø 50	60 cm	12	490.00
4026.TA050K.080.1	18816	Ø 50	80 cm	12	606.70

Duş kanalı / W200-330-400-500-600-800 mm / Ø 50 yan - alt çıkış  
Plastik gövde / Paslanmaz ızgara / Sulu koku tutucu



HM-31360

Prime koku tutucu kullanılmaktadır.

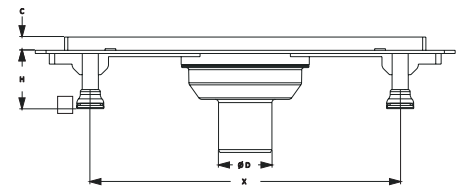
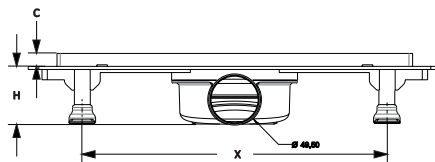
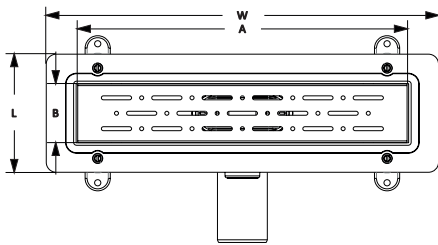

	W	L	H	Ø D	A	B	C	X	E
4024.0Y050K.033.1	389	119	55	50	335	64.5	12.5	287	1.2
4024.0Y050K.040.1	454	119	55	50	405	64.5	12.5	387	1.2
4024.0Y050K.050.1	554	119	55	50	505	64.5	12.5	487	1.2
4024.0Y050K.060.1	654	119	55	50	605	64.5	12.5	587	1.2

	W	L	H	Ø D	A	B	C	X	E
4024.0A050K.033.1	389	119	55	50	335	64.5	12.5	287	1.2
4024.0A050K.040.1	454	119	55	50	405	64.5	12.5	387	1.2
4024.0A050K.050.1	554	119	55	50	505	64.5	12.5	487	1.2
4024.0A050K.060.1	654	119	55	50	605	64.5	12.5	587	1.2

Tablo ölçü birimi "mm"dir.



RAIN



KARE



BAHN



DOLU

**SCALA Y360°**



**HM-31360**

Prime koku tutucu kullanılmaktadır.

Ürün Kodu	Kısa Kod	Çıkış	Ölçü		Fiyat
<b>YAN ÇIKIŞ</b>					
4030.0Y050K.033.1	30497	Ø 50	33 cm	12	320.00
4030.0Y050K.040.1	30501	Ø 50	40 cm	12	363.40
4030.0Y050K.050.1	30505	Ø 50	50 cm	12	406.70
4030.0Y050K.060.1	30509	Ø 50	60 cm	12	456.70
4030.0Y050K.080.1	30513	Ø 50	80 cm	12	563.40
<b>ALT ÇIKIŞ</b>					
4030.0A050K.033.1	30517	Ø 50	33 cm	12	320.00
4030.0A050K.040.1	30521	Ø 50	40 cm	12	363.40
4030.0A050K.050.1	30525	Ø 50	50 cm	12	406.70
4030.0A050K.060.1	30529	Ø 50	60 cm	12	456.70
4030.0A050K.080.1	30533	Ø 50	80 cm	12	563.40

Duş kanalı / W200-330-400-500-600-800 mm / Ø 50 yan - alt çıkış  
Plastik gövde / Paslanmaz ızgara / Sulu koku tutucu

**SCALA T.M. Y360°**



**HM-31360**

Prime koku tutucu kullanılmaktadır.

Ürün Kodu	Kısa Kod	Çıkış	Ölçü		Fiyat
<b>YAN ÇIKIŞ</b>					
4030.TY050K.033.1	30537	Ø 50	33 cm	12	370.00
4030.TY050K.040.1	30541	Ø 50	40 cm	12	416.70
4030.TY050K.050.1	30545	Ø 50	50 cm	12	470.00
4030.TY050K.060.1	30549	Ø 50	60 cm	12	526.70
4030.TY050K.080.1	30553	Ø 50	80 cm	12	643.40
<b>ALT ÇIKIŞ</b>					
4030.TA050K.033.1	30557	Ø 50	33 cm	12	370.00
4030.TA050K.040.1	30561	Ø 50	40 cm	12	416.70
4030.TA050K.050.1	30565	Ø 50	50 cm	12	470.00
4030.TA050K.060.1	30569	Ø 50	60 cm	12	526.70
4030.TA050K.080.1	30573	Ø 50	80 cm	12	643.40

Duş kanalı / W200-330-400-500-600-800 mm / Ø 50 yan - alt çıkış  
Plastik gövde / Paslanmaz ızgara / Sulu koku tutucu



## SCALA LEGAL

Ürün Kodu	Kısa Kod	Çıkış	Ölçü	Fiyat	
<b>YAN ÇIKIŞ</b>					
4027.0Y050K.033.1	17128	Ø 50	33 cm	12	360.00
4027.0Y050K.040.1	17131	Ø 50	40 cm	12	396.70
4027.0Y050K.050.1	17133	Ø 50	50 cm	12	453.40
4027.0Y050K.060.1	17135	Ø 50	60 cm	12	513.40
4027.0Y050K.080.1	18818	Ø 50	80 cm	12	640.00
<b>ALT ÇIKIŞ</b>					
4027.0A050K.033.1	17138	Ø 50	33 cm	12	360.00
4027.0A050K.040.1	17141	Ø 50	40 cm	12	396.70
4027.0A050K.050.1	17143	Ø 50	50 cm	12	453.40
4027.0A050K.060.1	17146	Ø 50	60 cm	12	513.40
4027.0A050K.080.1	18822	Ø 50	80 cm	12	640.00

Duş kanalı / W200-330-400-500-600-800 mm / Ø 50 yan - alt çıkış  
Plastik gövde / Paslanmaz çerçeve ve ızgara / Sulu koku tutucu

## SCALA LEGAL T.M.

Ürün Kodu	Kısa Kod	Çıkış	Ölçü	Fiyat	
<b>YAN ÇIKIŞ</b>					
4027.TY050K.033.1	17148	Ø 50	33 cm	12	396.70
4027.TY050K.040.1	17151	Ø 50	40 cm	12	453.40
4027.TY050K.050.1	17153	Ø 50	50 cm	12	520.00
4027.TY050K.060.1	17156	Ø 50	60 cm	12	586.70
4027.TY050K.080.1	18824	Ø 50	80 cm	12	723.40
<b>ALT ÇIKIŞ</b>					
4027.TA050K.033.1	17159	Ø 50	33 cm	12	396.70
4027.TA050K.040.1	17161	Ø 50	40 cm	12	453.40
4027.TA050K.050.1	17163	Ø 50	50 cm	12	520.00
4027.TA050K.060.1	17165	Ø 50	60 cm	12	586.70
4027.TA050K.080.1	18828	Ø 50	80 cm	12	723.40

Duş kanalı / W200-330-400-500-600-800 mm / Ø 50 yan - alt çıkış  
Plastik gövde / Paslanmaz çerçeve ve ızgara / Sulu koku tutucu



HM-31360

Prime koku tutucu kullanılmaktadır.



HM-31360

Prime koku tutucu kullanılmaktadır.



**SCALA LEGAL Y360°**



**HM-31360**

Prime koku tutucu kullanılmaktadır.

Ürün Kodu	Kısa Kod	Çıkış	Ölçü	Fiyat
<b>YAN ÇIKIŞ</b>				
4031.0Y050K.033.1	30577	Ø 50	33 cm	396.70
4031.0Y050K.040.1	30581	Ø 50	40 cm	433.40
4031.0Y050K.050.1	30585	Ø 50	50 cm	490.00
4031.0Y050K.060.1	30589	Ø 50	60 cm	550.00
4031.0Y050K.080.1	30593	Ø 50	80 cm	676.70
<b>ALT ÇIKIŞ</b>				
4031.0A050K.033.1	30597	Ø 50	33 cm	396.70
4031.0A050K.040.1	30601	Ø 50	40 cm	433.40
4031.0A050K.050.1	30605	Ø 50	50 cm	490.00
4031.0A050K.060.1	30609	Ø 50	60 cm	550.00
4031.0A050K.080.1	30613	Ø 50	80 cm	676.70

Duş kanalı / W200-330-400-500-600-800 mm / Ø 50 yan - alt çıkış  
Plastik gövde / Paslanmaz çerçeve ve ızgara / Sulu koku tutucu

**SCALA LEGAL T.M. Y360°**



**HM-31360**

Prime koku tutucu kullanılmaktadır.

Ürün Kodu	Kısa Kod	Çıkış	Ölçü	Fiyat
<b>YAN ÇIKIŞ</b>				
4031.TY050K.033.1	30617	Ø 50	33 cm	436.70
4031.TY050K.040.1	30621	Ø 50	40 cm	490.00
4031.TY050K.050.1	30625	Ø 50	50 cm	556.70
4031.TY050K.060.1	30629	Ø 50	60 cm	623.40
4031.TY050K.080.1	30633	Ø 50	80 cm	760.00
<b>ALT ÇIKIŞ</b>				
4031.TA050K.033.1	30637	Ø 50	33 cm	436.70
4031.TA050K.040.1	30641	Ø 50	40 cm	490.00
4031.TA050K.050.1	30645	Ø 50	50 cm	556.70
4031.TA050K.060.1	30649	Ø 50	60 cm	623.40
4031.TA050K.080.1	30653	Ø 50	80 cm	760.00

Duş kanalı / W200-330-400-500-600-800 mm / Ø 50 yan - alt çıkış  
Plastik gövde / Paslanmaz çerçeve ve ızgara / Sulu koku tutucu

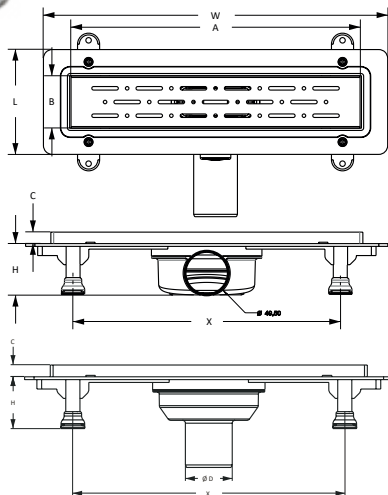

	W	L	H	Ø D	A	B	C	X	E
4023.0Y050K.033.1	389	119	55	50	335	64.5	12.5	287	1.2
4023.0Y050K.040.1	454	119	55	50	405	64.5	12.5	387	1.2
4023.0Y050K.050.1	554	119	55	50	505	64.5	12.5	487	1.2
4023.0Y050K.060.1	654	119	55	50	605	64.5	12.5	587	1.2
4023.0Y050K.080.1	854	119	55	50	805	64.5	12.5	787	1.2

**Detaylar**

DN 50 Yan ve Alt çıkış – Pvc boru bağlantılarına uyumludur. Akış hızı 32 lt/dk'dır. Iızgarası 304 kalite paslanmaz çeliklidir.

**Avantajlar**

304 kalite paslanmaz çelik ızgarası sayesinde şık ve kaliteli bir görünüme sahiptir. Duvar dibi uygulamalarda rahatlıkla uygulanabilir. Su tutuculu koku önleyici sayesinde tesisattan gelecek kötü kokuları önler. Yükseltme ayakları sayesinde şapın yüksekliğine göre ayarlama olanağı sağlar. Organik ve inorganik kimyasallara yüksek dayanım. çoğu asidik ve tuzlu su oksidasyonuna dayanıklıdır.

**Kullanım Alanları**

Genel kullanım banyo duşları, hastane ve otel duş alanları, soyunma odaları duş alanları vb.

**Özel Üretim**

Iızgara modeli olarak isteğinize göre altın, bronz gibi renkler de üretilmektedir.

**Uyarı**

Yüksek yoğunluklu temizlik malzemelerinin uzun süreli kullanımı tavsiye edilmez.

	W	L	H	Ø D	A	B	C	X	E
4023.0A050K.033.1	389	119	55	50	335	64.5	12.5	287	1.2
4023.0A050K.040.1	454	119	55	50	405	64.5	12.5	387	1.2
4023.0A050K.050.1	554	119	55	50	505	64.5	12.5	487	1.2
4023.0A050K.060.1	654	119	55	50	605	64.5	12.5	587	1.2
4023.0A050K.080.1	854	119	55	50	805	64.5	12.5	787	1.2

Tablo ölçü birimi "mm"dir.

## SCALA DELUXE

Ürün Kodu	Kısa Kod	Çıkış	Ölçü		Fiyat
<b>YAN ÇIKIŞ</b>					
4028.0Y050K.033.1	17173	Ø 50	33 cm	12	456.70
4028.0Y050K.040.1	17176	Ø 50	40 cm	12	500.00
4028.0Y050K.050.1	17177	Ø 50	50 cm	12	573.40
4028.0Y050K.060.1	17178	Ø 50	60 cm	12	660.00
4028.0Y050K.080.1	18830	Ø 50	80 cm	12	823.40
<b>ALT ÇIKIŞ</b>					
4028.0A050K.033.1	17167	Ø 50	33 cm	12	456.70
4028.0A050K.040.1	17174	Ø 50	40 cm	12	500.00
4028.0A050K.050.1	17175	Ø 50	50 cm	12	573.40
4028.0A050K.060.1	17179	Ø 50	60 cm	12	660.00
4028.0A050K.080.1	18831	Ø 50	80 cm	12	823.40

Duş kanalı / W200-330-400-500-600-800 mm / Ø 50 yan - alt çıkış  
Plastik gövde / Paslanmaz çerçeve ve ızgara / Sulu koku tutucu



HM-31360

Prime koku tutucu kullanılmaktadır.

## SCALA DELUXE T.M.

Ürün Kodu	Kısa Kod	Çıkış	Ölçü		Fiyat
<b>YAN ÇIKIŞ</b>					
4028.TY050K.033.1	17181	Ø 50	33 cm	12	510.00
4028.TY050K.040.1	17182	Ø 50	40 cm	12	560.00
4028.TY050K.050.1	17183	Ø 50	50 cm	12	640.00
4028.TY050K.060.1	17184	Ø 50	60 cm	12	733.40
4028.TY050K.080.1	18832	Ø 50	80 cm	12	906.70
<b>ALT ÇIKIŞ</b>					
4028.TA050K.033.1	17180	Ø 50	33 cm	12	510.00
4028.TA050K.040.1	17185	Ø 50	40 cm	12	560.00
4028.TA050K.050.1	17187	Ø 50	50 cm	12	640.00
4028.TA050K.060.1	17188	Ø 50	60 cm	12	733.40
4028.TA050K.080.1	18833	Ø 50	80 cm	12	906.70

Duş kanalı / W200-330-400-500-600-800 mm / Ø 50 yan - alt çıkış  
Plastik gövde / Paslanmaz çerçeve ve ızgara / Sulu koku tutucu



HM-31360

Prime koku tutucu kullanılmaktadır.

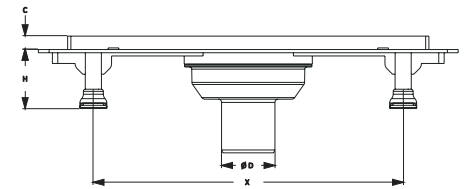
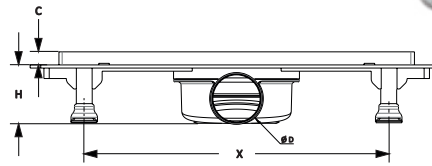
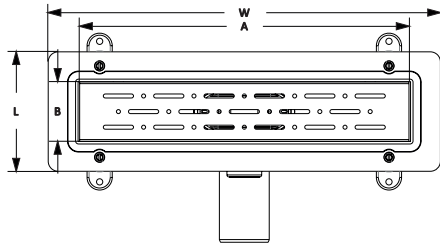

	W	L	H	Ø D	A	B	C	X	E
4028.0Y050K.033.1	389	119	55	50	335	64.5	12.5	287	1.2
4028.0Y050K.040.1	454	119	55	50	405	64.5	12.5	387	1.2
4028.0Y050K.050.1	554	119	55	50	505	64.5	12.5	487	1.2
4028.0Y050K.060.1	654	119	55	50	605	64.5	12.5	587	1.2

	W	L	H	Ø D	A	B	C	X	E
4028.0A050K.033.1	389	119	55	50	335	64.5	12.5	287	1.2
4028.0A050K.040.1	454	119	55	50	405	64.5	12.5	387	1.2
4028.0A050K.050.1	554	119	55	50	505	64.5	12.5	487	1.2
4028.0A050K.060.1	654	119	55	50	605	64.5	12.5	587	1.2

Tablo ölçü birimi "mm"dir.

**Detaylar**

DN 50 Yan ve Alt çıkış - Pvc boru bağlantılarına uyumludur. Akış hızı 32 lt/dk'dır. Iızgarası 304 kalite paslanmaz çeliklidir.

**Avantajlar**

304 kalite paslanmaz çelik ızgarası sayesinde şık ve kaliteli bir görünüme sahiptir. Duvar dibi uygulamalarda rahatlıkla uygulanabilir. Su tutuculu koku önleyici sayesinde tesisattan gelecek kötü kokuları önler. Yükseltme ayakları sayesinde şapın yüksekliğine göre ayarlama olanağı sağlar. Organik ve inorganik kimyasallara yüksek dayanım. çoğu asidik ve tuzlu su oksidasyonuna dayanıklıdır.

**Kullanım Alanları**

Genel kullanım banyo duşları, hastane ve otel duş alanları, soyunma odaları duş alanları vb.

**Özel Üretim**

Iızgara modeli olarak isteğinize göre altın, bronz gibi renkler de üretilmektedir.

**Uyarı**

Yüksek yoğunluklu temizlik malzemelerinin uzun süreli kullanımı tavsiye edilmez.

**SCALA DELUXE Y360°**



**HM-31360**

Prime koku tutucu kullanılmaktadır.

Ürün Kodu	Kısa Kod	Çıkış	Ölçü		Fiyat
<b>YAN ÇIKIŞ</b>					
4034.0Y050K.033.1	30657	Ø 50	33 cm	12	493.40
4034.0Y050K.040.1	30661	Ø 50	40 cm	12	540.00
4034.0Y050K.050.1	30665	Ø 50	50 cm	12	613.40
4034.0Y050K.060.1	30669	Ø 50	60 cm	12	696.70
4034.0Y050K.080.1	30673	Ø 50	80 cm	12	863.40
<b>ALT ÇIKIŞ</b>					
4034.0A050K.033.1	30677	Ø 50	33 cm	12	493.40
4034.0A050K.040.1	30681	Ø 50	40 cm	12	540.00
4034.0A050K.050.1	30685	Ø 50	50 cm	12	613.40
4034.0A050K.060.1	30689	Ø 50	60 cm	12	696.70
4034.0A050K.080.1	30693	Ø 50	80 cm	12	863.40

Duş kanalı / W200-330-400-500-600-800 mm / Ø 50 yan - alt çıkış  
Plastik gövde / Paslanmaz çerçeve ve ızgara / Sulu koku tutucu

**SCALA DELUXE T.M. Y360°**



**HM-31360**

Prime koku tutucu kullanılmaktadır.

Ürün Kodu	Kısa Kod	Çıkış	Ölçü		Fiyat
<b>YAN ÇIKIŞ</b>					
4034.TY050K.033.1	30697	Ø 50	33 cm	12	546.70
4034.TY050K.040.1	30701	Ø 50	40 cm	12	596.70
4034.TY050K.050.1	30705	Ø 50	50 cm	12	676.70
4034.TY050K.060.1	30709	Ø 50	60 cm	12	770.00
4034.TY050K.080.1	30713	Ø 50	80 cm	12	943.40
<b>ALT ÇIKIŞ</b>					
4034.TA050K.033.1	30717	Ø 50	33 cm	12	546.70
4034.TA050K.040.1	30721	Ø 50	40 cm	12	596.70
4034.TA050K.050.1	30725	Ø 50	50 cm	12	676.70
4034.TA050K.060.1	30729	Ø 50	60 cm	12	770.00
4034.TA050K.080.1	30733	Ø 50	80 cm	12	943.40

Duş kanalı / W200-330-400-500-600-800 mm / Ø 50 yan - alt çıkış  
Plastik gövde / Paslanmaz çerçeve ve ızgara / Sulu koku tutucu





## LINE

Ürün Kodu	Kısa Kod	Çıkış	Ölçü		Fiyat
<b>YAN ÇIKIŞ</b>					
4033.0Y050K.033.1	17186	Ø 50	33 cm	12	470.00
4033.0Y050K.040.1	17203	Ø 50	40 cm	12	546.70
4033.0Y050K.050.1	17216	Ø 50	50 cm	12	676.70
4033.0Y050K.060.1	17236	Ø 50	60 cm	12	766.70
4033.0Y050K.080.1	17249	Ø 50	80 cm	12	940.00
<b>ALT ÇIKIŞ</b>					
4033.0A050K.033.1	17189	Ø 50	33 cm	12	470.00
4033.0A050K.040.1	17214	Ø 50	40 cm	12	546.70
4033.0A050K.050.1	17233	Ø 50	50 cm	12	676.70
4033.0A050K.060.1	17261	Ø 50	60 cm	12	766.70
4033.0A050K.080.1	17282	Ø 50	80 cm	12	940.00

Duş kanalı / W200-330-400-500-600 mm / Ø 50 yan - alt çıkış  
Paslanmaz gövde / Paslanmaz ızgara / Sulu koku tutucu



**HM-31361**

Uzun koku tutucu kullanılmaktadır.

## LINE T.M.

Ürün Kodu	Kısa Kod	Çıkış	Ölçü		Fiyat
<b>YAN ÇIKIŞ</b>					
4033.TY050K.033.1	17358	Ø 50	33 cm	12	520.00
4033.TY050K.040.1	17372	Ø 50	40 cm	12	600.00
4033.TY050K.050.1	17398	Ø 50	50 cm	12	726.70
4033.TY050K.060.1	17410	Ø 50	60 cm	12	806.70
4033.TY050K.080.1	17434	Ø 50	80 cm	12	993.40
<b>ALT ÇIKIŞ</b>					
4033.TA050K.033.1	17385	Ø 50	33 cm	12	520.00
4033.TA050K.040.1	17411	Ø 50	40 cm	12	600.00
4033.TA050K.050.1	17426	Ø 50	50 cm	12	726.70
4033.TA050K.060.1	17444	Ø 50	60 cm	12	806.70
4033.TA050K.080.1	17467	Ø 50	80 cm	12	993.40

Duş kanalı / W200-330-400-500-600 mm / Ø 50 yan - alt çıkış  
Paslanmaz gövde / Paslanmaz ızgara / Sulu koku tutucu



**HM-31361**

Uzun koku tutucu kullanılmaktadır.

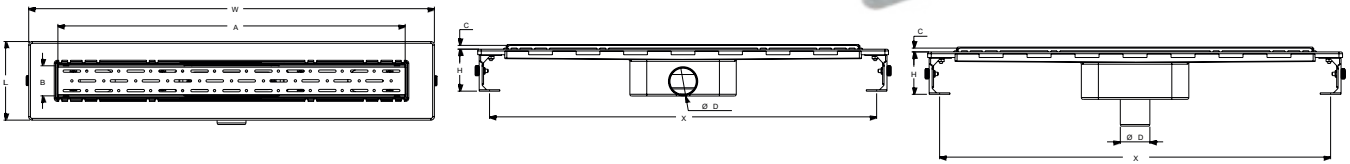

ÜRÜN KODU	W	L	H	ØD	A	B	C	X	E
4033.TY050K.033.1	423	134	72	49.5	330	54	8	385	1.5
4033.TY050K.040.1	492	134	72	49.5	400	54	8	456	1.5
4033.TY050K.050.1	592	134	72	49.5	500	54	8	556	1.5
4033.TY050K.060.1	693	134	72	49.5	600	54	8	656	1.5
4033.TY050K.080.1	893	134	72	49.5	800	54	8	856	1.5

ÜRÜN KODU	W	L	H	ØD	A	B	C	X	E
4033.TA050K.033.1	423	134	100	49.5	330	54	8	385	1.5
4033.TA050K.040.1	492	134	100	49.5	400	54	8	456	1.5
4033.TA050K.050.1	592	134	100	49.5	500	54	8	556	1.5
4033.TA050K.060.1	693	134	100	49.5	600	54	8	656	1.5
4033.TA050K.080.1	893	134	100	49.5	800	54	8	856	1.5

Tablo ölçü birimi "mm"dir.

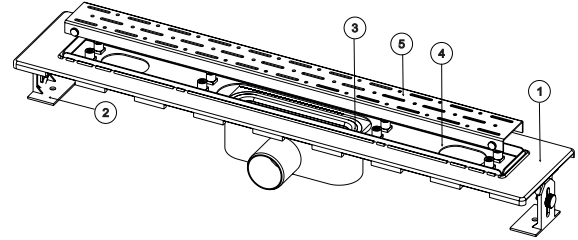

PARÇA NO	PARÇA AÇIKLAMASI	MALZEME	ADET
4033.1	Plastik Gövde Etekli	ABS	1
4033.2	Yükseklik Ayarlı Montaj Seti	PP	2
4033.3	Koku Tutucu	ABS	1
4033.4	Yük. Ayarlı Çerçeve	AISI 304	1
4033.5	Paslanmaz Izgara	AISI 304	1

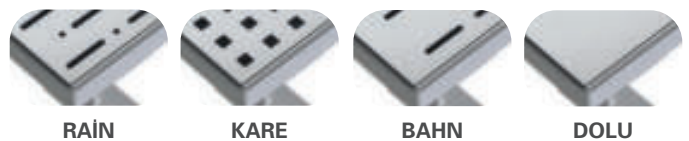

RAIN

KARE

BAHN

DOLU



**HM-31363**

Legal koku tutucu kullanılmaktadır.

**LEGAL**

Ürün Kodu	Kısa Kod	Çıkış	Ölçü		Fiyat
<b>YAN ÇIKIŞ</b>					
4043.0Y050K.033.1	17524	Ø 50	33 cm	12	843.40
4043.0Y050K.040.1	17538	Ø 50	40 cm	12	910.00
4043.0Y050K.050.1	17557	Ø 50	50 cm	12	1096.70
4043.0Y050K.060.1	17575	Ø 50	60 cm	12	1243.40
4043.0Y050K.080.1	18834	Ø 50	80 cm	12	1503.40
<b>ALT ÇIKIŞ</b>					
4043.0A050K.033.1	17601	Ø 50	33 cm	12	843.40
4043.0A050K.040.1	17619	Ø 50	40 cm	12	910.00
4043.0A050K.050.1	17640	Ø 50	50 cm	12	1096.70
4043.0A050K.060.1	17661	Ø 50	60 cm	12	1243.40
4043.0A050K.080.1	18994	Ø 50	80 cm	12	1503.40

Duş kanalı / W200-330-400-500-600 mm / Ø 50 yan - alt çıkış  
Paslanmaz gövde / Paslanmaz ızgara / Sulu koku tutucu

**LEGAL T.M.**

Ürün Kodu	Kısa Kod	Çıkış	Ölçü		Fiyat
<b>YAN ÇIKIŞ</b>					
4043.TY050K.033.1	17717	Ø 50	33 cm	12	870.00
4043.TY050K.040.1	17732	Ø 50	40 cm	12	993.40
4043.TY050K.050.1	17750	Ø 50	50 cm	12	1176.70
4043.TY050K.060.1	17767	Ø 50	60 cm	12	1310.00
4043.TY050K.080.1	17783	Ø 50	80 cm	12	1586.70
<b>ALT ÇIKIŞ</b>					
4043.TA050K.033.1	17771	Ø 50	33 cm	12	870.00
4043.TA050K.040.1	17789	Ø 50	40 cm	12	993.40
4043.TA050K.050.1	17801	Ø 50	50 cm	12	1176.70
4043.TA050K.060.1	17810	Ø 50	60 cm	12	1310.00
4043.TA050K.080.1	17823	Ø 50	80 cm	12	1586.70

Duş kanalı / W200-330-400-500-600 mm / Ø 50 yan - alt çıkış  
Paslanmaz gövde / Paslanmaz ızgara / Sulu koku tutucu



**HM-31363**

Legal koku tutucu kullanılmaktadır.

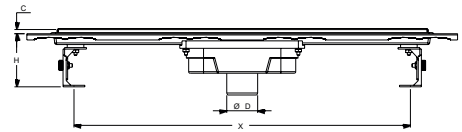
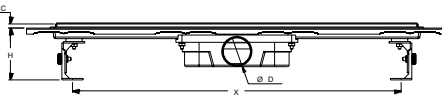
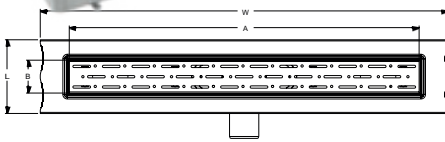

ÜRÜN KODU	W	L	H	ØD	A	B	C	X	E
4043.TY050K.033.1	423	134	85	49.5	330	54	8	385	1.5
4043.TY050K.040.1	492	134	85	49.5	400	54	8	456	1.5
4043.TY050K.050.1	592	134	85	49.5	500	54	8	556	1.5
4043.TY050K.060.1	693	134	85	49.5	600	54	8	656	1.5
4043.TY050K.080.1	893	134	85	49.5	800	54	8	856	1.5

PARÇA NO	PARÇA AÇIKLAMASI	MALZEME	ADET
4043.1	Plastik Alt Gövde	ABS	1
4043.2	Paslanmaz Üst Gövde	AISI 304	1
4043.3	Yükseklik Ayarlı Montaj Seti	PP	2
4043.4	Yükseklik Ayarlı Çerçeve	AISI 304	1
4043.5	Paslanmaz Iızgara	AISI 304	1
4043.6	Koku Tutucu	ABS	1

ÜRÜN KODU	W	L	H	ØD	A	B	C	X	E
4043.TA050K.033.1	423	134	100	49.5	330	54	8	385	1.5
4043.TA050K.040.1	492	134	100	49.5	400	54	8	456	1.5
4043.TA050K.050.1	592	134	100	49.5	500	54	8	556	1.5
4043.TA050K.060.1	693	134	100	49.5	600	54	8	656	1.5
4043.TA050K.080.1	893	134	100	49.5	800	54	8	856	1.5

Tablo ölçü birimi "mm"dir.

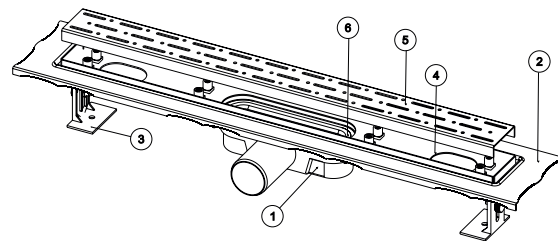



HM-31363

Legal koku tutucu kullanılmaktadır.

## LEGAL Y360°

Ürün Kodu	Kısa Kod	Çıkış	Ölçü		Fiyat
<b>YAN ÇIKIŞ</b>					
4043.0Y360K.033.1	18012	Ø 50	33 cm	12	883.40
4043.0Y360K.040.1	18021	Ø 50	40 cm	12	986.70
4043.0Y360K.050.1	18030	Ø 50	50 cm	12	1176.70
4043.0Y360K.060.1	18039	Ø 50	60 cm	12	1330.00
4043.0Y360K.080.1	18048	Ø 50	80 cm	12	1603.40
<b>ALT ÇIKIŞ</b>					
4043.0A360K.033.1	31395	Ø 50	33 cm	12	883.40
4043.0A360K.040.1	31396	Ø 50	40 cm	12	986.70
4043.0A360K.050.1	31397	Ø 50	50 cm	12	1176.70
4043.0A360K.060.1	31398	Ø 50	60 cm	12	1330.00
4043.0A360K.080.1	31399	Ø 50	80 cm	12	1603.40

Duş kanalı / W200-330-400-500-600 mm / Ø 50 yan - alt çıkış  
Paslanmaz gövde / Paslanmaz ızgara / Sulu koku tutucu

## PREMIUM

Ürün Kodu	Kısa Kod	Çıkış	Ölçü		Fiyat
<b>YAN ÇIKIŞ</b>					
4045.0Y050K.033.9	18059	Ø 50	33 cm	12	1473.40
4045.0Y050K.045.9	18062	Ø 50	45 cm	12	1783.40
4045.0Y050K.060.9	18065	Ø 50	60 cm	12	2293.40
4045.0Y050K.080.9	18068	Ø 50	80 cm	12	2996.70
<b>ALT ÇIKIŞ</b>					
4045.0A050K.033.9	18070	Ø 50	33 cm	12	1473.40
4045.0A050K.045.9	18072	Ø 50	45 cm	12	1783.40
4045.0A050K.060.9	18074	Ø 50	60 cm	12	2293.40
4045.0A050K.080.9	18076	Ø 50	80 cm	12	2996.70

Duş kanalı / W200-330-400-500-600 mm / Ø 50 yan - alt çıkış  
Paslanmaz gövde / Paslanmaz ızgara / Sulu koku tutucu



HM-31363

Legal koku tutucu kullanılmaktadır.

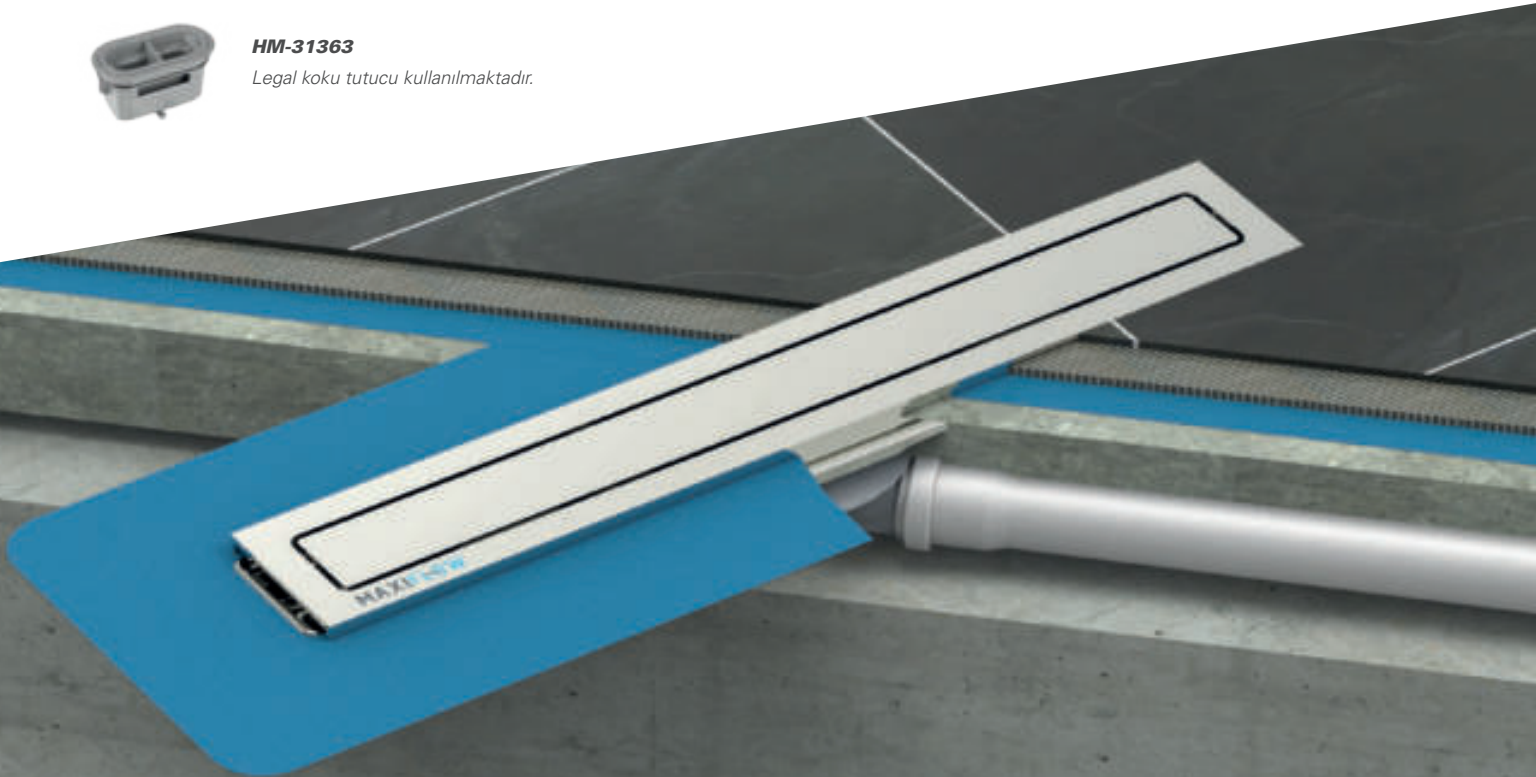



**HM-31361**

Uzun koku tutucu kullanılmaktadır.

**LINE**

Ürün Kodu	Kısa Kod	Çıkış	Ölçü	Fiyat
<b>YAN ÇIKIŞ</b>				
4072.0Y050K.020.1	18154	Ø 50	20x20 cm	360.00
<b>ALT ÇIKIŞ</b>				
4072.0A050K.020.1	18156	Ø 50	20x20 cm	360.00

Duş kanalı / 200x200 mm / Ø 50 yan - alt çıkış  
Plastik gövde / Paslanmaz ızgara / Sulu koku tutucu



**HM-31363**

Legal koku tutucu kullanılmaktadır.

**LEGAL**

Ürün Kodu	Kısa Kod	Çıkış	Ölçü	Fiyat
<b>YAN ÇIKIŞ</b>				
4073.0Y050K.020.1	18160	Ø 50	20x20 cm	676.70
<b>ALT ÇIKIŞ</b>				
4073.0A050K.020.1	18164	Ø 50	20x20 cm	676.70

Duş kanalı / 200x200 mm / Ø 50 yan - alt çıkış  
Paslanmaz gövde / Paslanmaz ızgara / Sulu koku tutucu

**LEGAL Y360°**

Ürün Kodu	Kısa Kod	Çıkış	Ölçü	Fiyat
<b>YAN ÇIKIŞ</b>				
4073.0Y360K.020.1	18176	Ø 50	20x20 cm	713.40
<b>ALT ÇIKIŞ</b>				
4073.0A360K.020.1	31400	Ø 50	20x20 cm	713.40

Duş kanalı / 200x200 mm / Ø 50 yan - alt çıkış  
Paslanmaz gövde / Paslanmaz ızgara / Sulu koku tutucu



**HM-31363**

Legal koku tutucu kullanılmaktadır.

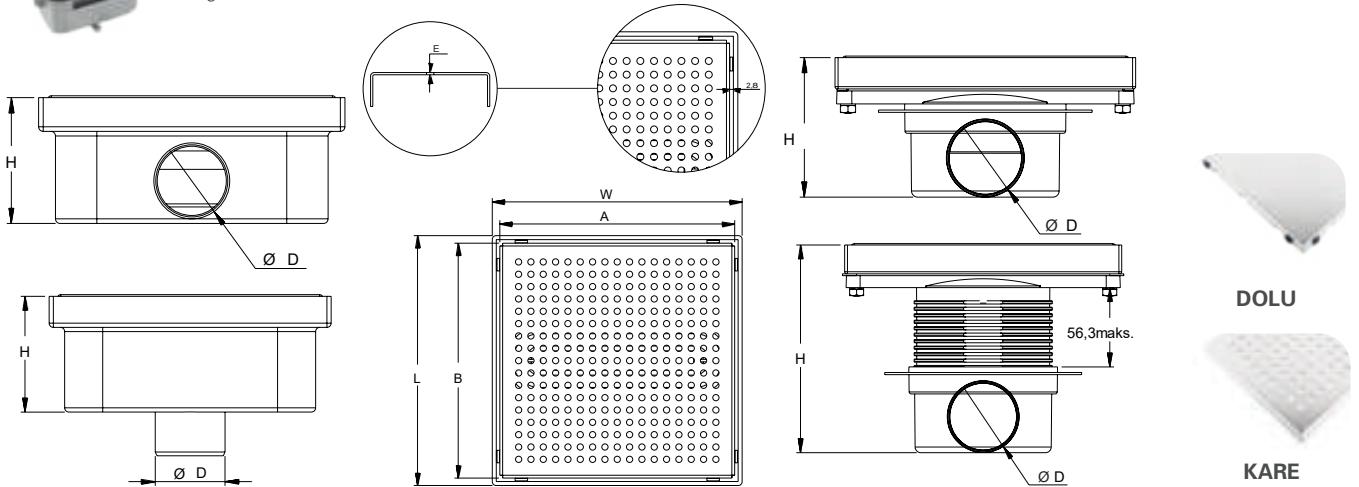

ÜRÜN KODU	W	L	H	Ø D	A	B	E
4072.0Y050K.020.0	200	200	82	49.5	188	188	1.5
4072.0A050K.020.0	200	200	82	49.5	188	188	1.5

ÜRÜN KODU	W	L	H	Ø D	A	B	E
4073.00360K.020.0	200	200	91	49.5	188	188	1.5
4073.0Y360K.020.0	200	200	148	49.5	188	188	1.5



**HM-31361**

Uzun koku tutucu kullanılmaktadır.

## LINE

Ürün Kodu	Kısa Kod	Çıkış	Ölçü		Fiyat
<b>YAN ÇIKIŞ</b>					
4062.0Y050K.033.1	18117	Ø 50	33 cm	12	286.70
<b>ALT ÇIKIŞ</b>					
4062.0A050K.033.1	18121	Ø 50	33 cm	12	286.70



**HM-31363**

Legal koku tutucu kullanılmaktadır.

## LEGAL

Ürün Kodu	Kısa Kod	Çıkış	Ölçü		Fiyat
<b>YAN ÇIKIŞ</b>					
4063.0Y050K.033.1	18137	Ø 50	33 cm	12	510.00
<b>ALT ÇIKIŞ</b>					
4063.0A050K.033.1	18140	Ø 50	33 cm	12	510.00



**HM-31363**

Legal koku tutucu kullanılmaktadır.

## LEGAL Y360°

Ürün Kodu	Kısa Kod	Çıkış	Ölçü		Fiyat
<b>YAN ÇIKIŞ</b>					
4063.0Y360K.033.1	18150	Ø 50	33 cm	12	553.40
<b>ALT ÇIKIŞ</b>					
4063.0A360K.033.1	31401	Ø 50	33 cm	12	553.40



**DOLU**



**KARE**

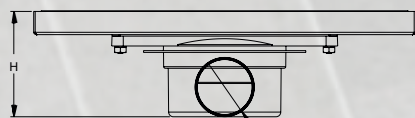
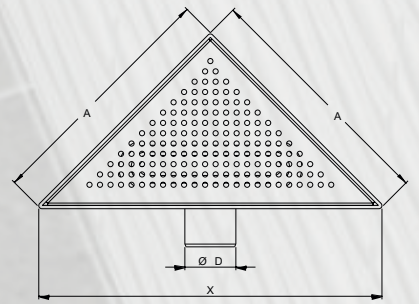
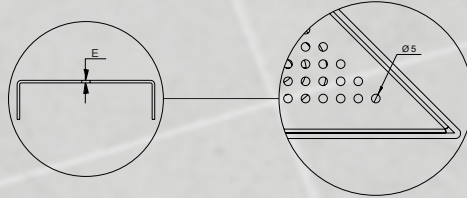
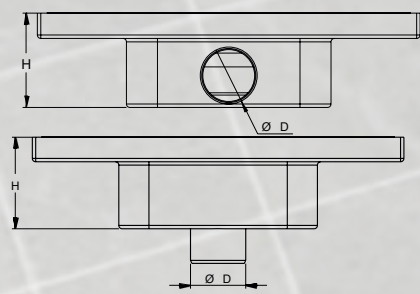

ÜRÜN KODU	H	Ø D	A	X	E
4062.0Y050K.033.0	84	49.5	234	330	1.5

ÜRÜN KODU	H	Ø D	A	X	E
4062.0A050K.033.0	84	49.5	234	330	1.5

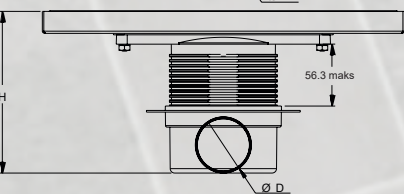

ÜRÜN KODU	H	Ø D	A	X	E
4063.00360K.033.0	91	49.5	234	330	1.5

ÜRÜN KODU	H	Ø D	A	X	E
4063.0Y360K.033.0	147	49.5	234	330	1.5

Tablo ölçü birimi "mm"dir.

## KANAL OLUĞU 100x500 mm

Ürün Kodu	Kısa Kod	Ölçü	Yükseklik	Fiyat
<b>BEYAZ</b>				
7010.05005Y.0.0	13659	100x500 mm	50 mm	40
7011.05005A.0.0	13660	100x500 mm A.Ç.	50 mm	32
<b>SİYAH</b>				
7010.05005Y.0.S	26863	100x500 mm	50 mm	40
7011.05005A.0.S	26864	100x500 mm A.Ç.	50 mm	32



• Plastik gövde

## PLASTİK KANAL IZGARASI 100x500mm

Ürün Kodu	Kısa Kod	Ölçü	Yükseklik	Fiyat
<b>BEYAZ</b>				
7110.050120.0.0	13653	100x500 mm	-	40
<b>SİYAH</b>				
7110.050120.0.S	26865	100x500 mm	-	40

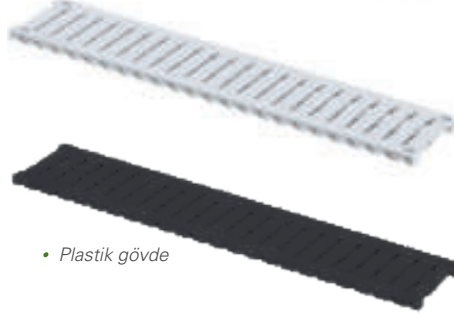

• Plastik gövde

## PASLANMAZ KANAL IZGARASI 100x500 mm

Ürün Kodu	Kısa Kod	Ölçü	Kalite	Desen	Fiyat
2110.05012R304.2	13745	100x500 mm	S.S.304	Kare	313.40
2110.10012R304.2	13780	100x1000 mm	S.S.304	Kare	610.00
2110.05012G.430.1	13749	100x500 mm	Galvaniz	Kare	116.70
2110.05012G.430.2	13784	100x1000 mm	Galvaniz	Kare	220.00



• Paslanmaz Izgara

## KANAL TAPASI 100 mm

Ürün Kodu	Kısa Kod	Ölçü	Yükseklik	Fiyat
<b>BEYAZ</b>				
7210.00050Y.0.0	13667	80x63 mm	-	150
<b>SİYAH</b>				
7210.00050Y.0.S	26866	80x63 mm	-	150



• Plastik gövde  
• Ø 32 çıkış

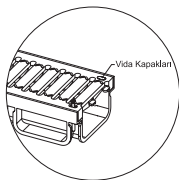
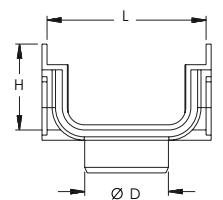
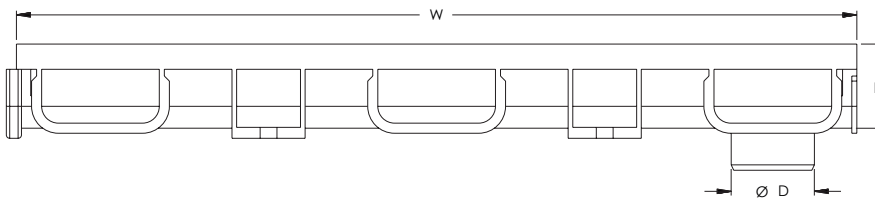
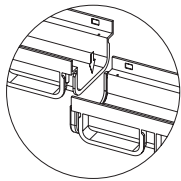
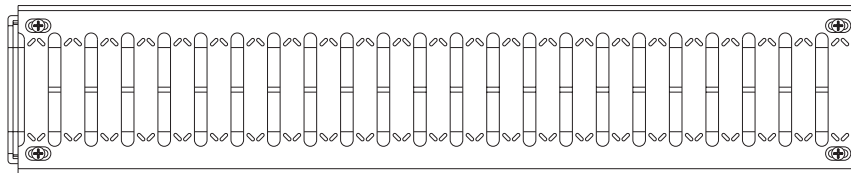
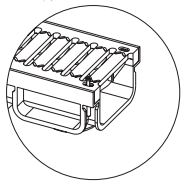

## IZGARA DESEN SEÇENEKLERİ



PLASTİK



KARE

- PP
- AISI 304
- AISI 430
- Galvaniz
- Sfero Döküm

- AISI 304
- AISI 430
- Galvaniz

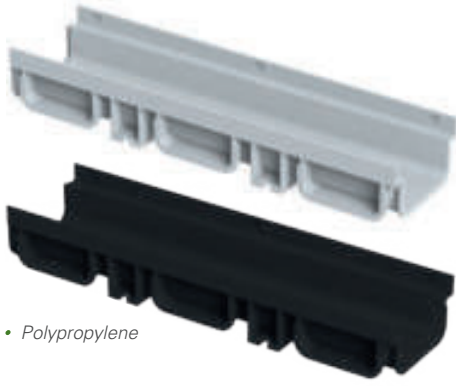

• Polypropylene

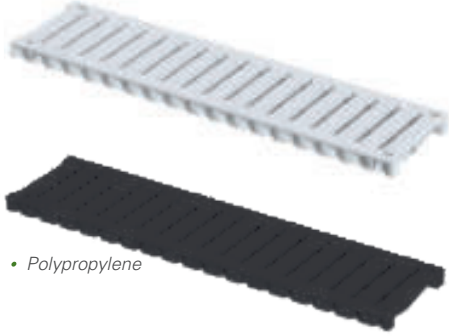

• Polypropylene



• Paslanmaz



• Pük Döküm



7212.00070Y.0.0 7227.00070Y.0.0 7228.00070Y.0.0



7212.00070Y.0.S 7227.00070Y.0.S 7228.00070Y.0.S

• Polypropylene  
• Ø 50 çıkış

**KANAL OLUĞU 130x500 mm**

Ürün Kodu	Kısa Kod	Ölçü	Yükseklik	Çıkış	Fiyat	
<b>BEYAZ</b>						
7013.05008Y.0.0	13661	130x500 mm	75 mm	-	40	73.40
7014.05008A.0.0	13662	130x500 mm A.Ç.	75 mm	Ø 49.5 / 74.5	32	76.70
<b>SİYAH</b>						
7013.05008Y.0.0	25118	130x500 mm	75 mm	-	40	73.40
7014.05008A.0.0	25119	130x500 mm A.Ç.	75 mm	Ø 49.5 / 74.5	32	76.70

**PLASTİK KANAL IZGARASI 130x500mm**

Ürün Kodu	Kısa Kod	Ölçü	Yükseklik	Fiyat	
<b>BEYAZ</b>					
7113.050200.0.0	13655	130x500 mm	-	40	63.40
<b>SİYAH</b>					
7113.050200.0.S	25120	130x500 mm	-	40	63.40

**PASLANMAZ KANAL IZGARASI**

Ürün Kodu	Kısa Kod	Ölçü	Kalite	Desen	Fiyat
<b>130x500 MM</b>					
2113.05020P.304.2	13811	130x500 mm	S.S.304	Kare 1	406.70
2113.05020P.304.4	13788	130x500 mm	S.S.304	Standart	330.00
<b>130x1000 MM</b>					
2113.10020P.304.2	13833	130x1000 mm	S.S.304	Kare	800.00
2113.10020P.304.4	13821	130x1000 mm	S.S.304	Standart	646.70
<b>GALVANİZ</b>					
2113.05020P.430.4	13797	130x500 mm	Galvaniz	Standart	123.40
2113.10021P.430.4	13825	130x1000 mm	Galvaniz	Standart	233.40

**SFERO DÖKÜM KANAL IZGARASI 130x500mm**

Ürün Kodu	Kısa Kod	Ölçü	Desen	Fiyat	
2113.05020D.000.4	18172	130x500 mm	Standart	1	560.00

**KANAL TAPASI 130 mm**

Ürün Kodu	Kısa Kod	Ölçü	Açıklama	Fiyat	
<b>BEYAZ</b>					
7212.00070Y.0.0	13668	125x75 mm	Erkek tapa çıkışlı	150	23.40
7227.00070Y.0.0	13669	125x75 mm	Dişi tapa	150	23.40
7228.00070Y.0.0	13670	125x75 mm	Dişi tapa çıkışlı	150	23.40
<b>SİYAH</b>					
7212.00070Y.0.S	26104	125x75 mm	Erkek tapa çıkışlı	150	23.40
7227.00070Y.0.S	27108	125x75 mm	Dişi tapa	150	23.40
7228.00070Y.0.S	27109	125x75 mm	Dişi tapa çıkışlı	150	23.40



# DRENAJ KANALLARI

## KANAL OLUĞU 130x1000 mm

**MAXIFLOW**  
Maksimum akış...

Ürün Kodu	Kısa Kod	Ölçü	Yükseklik	Çıkış		Fiyat
<b>BEYAZ</b>						
7015.10010Y.0.0	13663	130x1000 mm	100 mm	-	20	156.70
7016.10010A.0.0	13664	130x1000 mm A.Ç.	100 mm	Ø 49.5 / 74.5	16	166.70
<b>SİYAH</b>						
7015.10010Y.0.S	27104	130x1000 mm	100 mm	-	20	156.70
7016.10010A.0.S	27105	130x1000mmA.Ç.	100 mm	Ø 49.5 / 74.5	16	166.70

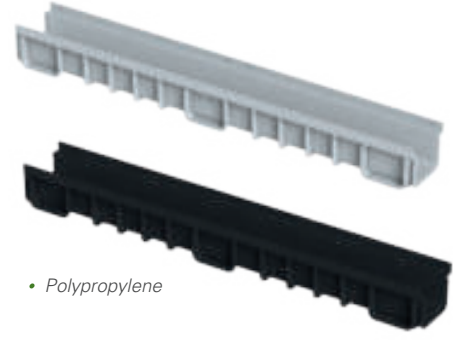

• Polypropylene

## PLASTİK KANAL IZGARASI 130x500mm

Ürün Kodu	Kısa Kod	Ölçü	Yükseklik		Fiyat
<b>BEYAZ</b>					
7113.050200.0.0	13655	130x500 mm	-	40	63.40
<b>SİYAH</b>					
7113.050200.0.S	25120	130x500 mm	-	40	63.40

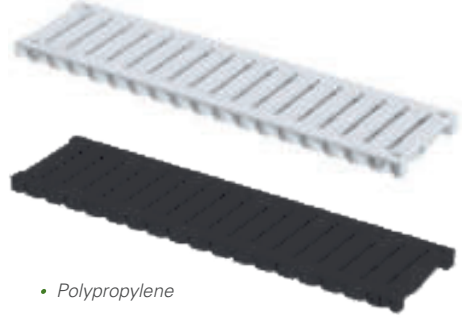

• Polypropylene

## KANAL TAPASI 130 mm

Ürün Kodu	Kısa Kod	Ölçü	Açıklama		Fiyat
<b>BEYAZ</b>					
7213.00100Y.0.B	13671	125x100 mm	Erkek tapa çıkışlı	150	23.40
7230.00100Y.0.B	13672	125x100 mm	Dişi tapa	150	23.40
7231.00100Y.0.B	13673	125x100 mm	Dişi tapa çıkışlı	150	23.40
<b>SİYAH</b>					
7213.00100Y.0.S	27112	125x100 mm	Erkek tapa çıkışlı	150	23.40
7230.00100Y.0.S	27110	125x100 mm	Dişi tapa	150	23.40
7231.00100Y.0.S	27111	125x100 mm	Dişi tapa çıkışlı	150	23.40



• Polypropylene  
• Ø 70 çıkış

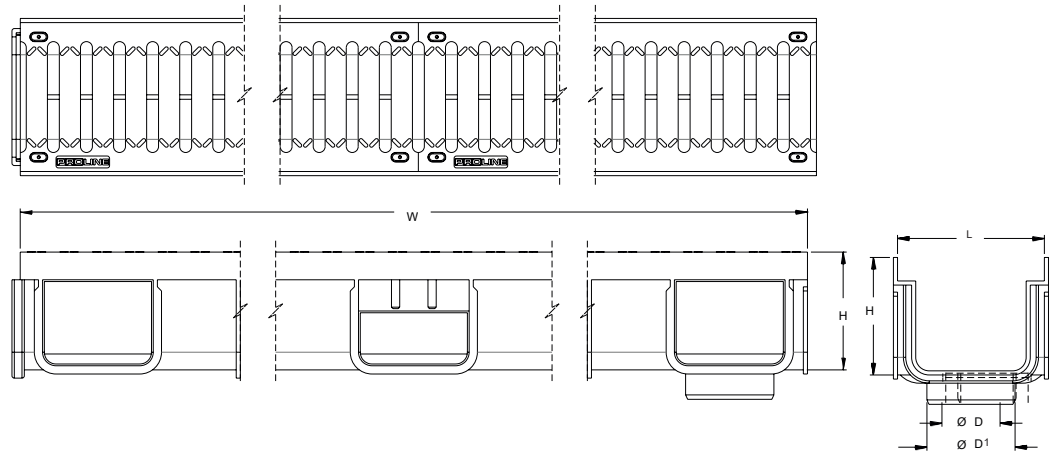
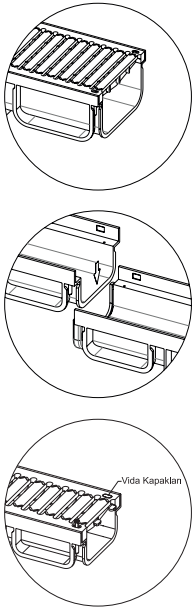

## IZGARA DESEN SEÇENEKLERİ

ÜRÜN KODU	W	L	H	Ø D	Ø D1
7015.10010Y.0.0	1000	125	75	-	-
7016.10010A.0.0	1000	125	75	49.5	74.5



PLASTİK



KARE

• PP  
• AISI 304  
• AISI 430  
• Galvaniz  
• Sfero Döküm

• AISI 304  
• AISI 430  
• Galvaniz

**KANAL OLUĞU 130x1000 mm**



Ürün Kodu	Kısa Kod	Ölçü	Yükseklik	Çıkış	Fiyat
<b>BEYAZ</b>					
7017.10008A.0.0	30890	130x1000 mm	75 mm	Ø 49.5 / 74.5 / 99.5	20 163.40
<b>SİYAH</b>					
7317.10008A.0.S	30891	130x1000 mm	75 mm	Ø 49.5 / 74.5 / 99.5	20 163.40

**PLASTİK KANAL IZGARASI 130x1000mm**



Ürün Kodu	Kısa Kod	Ölçü	Yükseklik	Fiyat
<b>BEYAZ</b>				
7114.100120.0.0	30892	130x1000 mm	-	20 123.40
<b>SİYAH</b>				
7414.100120.0.S	30893	130x1000 mm	-	20 123.40

**KANAL TAPASI 130 mm**

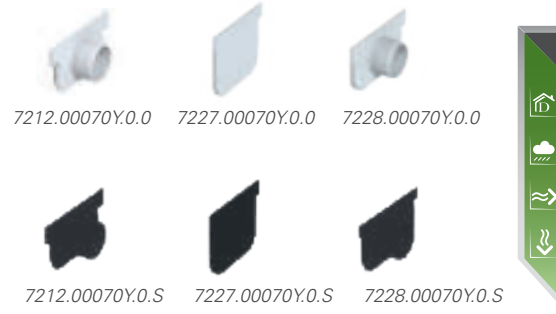

Ürün Kodu	Kısa Kod	Ölçü	Açıklama	Fiyat
<b>BEYAZ</b>				
7212.00070Y.0.0	13668	125x75 mm	Erkek tapa çıkışlı	150 23.40
7227.00070Y.0.0	13669	125x75 mm	Dişi tapa	150 23.40
7228.00070Y.0.0	13670	125x75 mm	Dişi tapa çıkışlı	150 23.40
<b>SİYAH</b>				
7212.00070Y.0.S	26104	125x75 mm	Erkek tapa çıkışlı	150 23.40
7227.00070Y.0.S	27108	125x75 mm	Dişi tapa	150 23.40
7228.00070Y.0.S	27109	125x75 mm	Dişi tapa çıkışlı	150 23.40

- Polypropylene
- Ø 50 çıkış

**IZGARA DESEN SEÇENEKLERİ**



- PP
- AISI 304
- AISI 430
- Galvaniz
- Sfero Döküm

- AISI 304
- AISI 430
- Galvaniz

ÜRÜN KODU	W	L	H	Ø D	Ø D1
7015.10010Y.0.0	1000	125	75	-	-
7016.10010A.0.0	1000	125	75	49.5	74.5

## KANAL OLUĞU 200x500 mm

Ürün Kodu	Kısa Kod	Ölçü	Yükseklik	Fiyat
<b>BEYAZ</b>				
7020.05013Y.0.0	13665	200x500 mm	120 mm	20
7020.05013A.0.0	13666	200x500 mm A.Ç.	120 mm	18
<b>SİYAH</b>				
7020.05013Y.0.S	26920	200x500 mm	120 mm	20
7020.05013A.0.S	26921	200x500 mm A.Ç.	120 mm	18



• Polypropylene

## PLASTİK KANAL IZGARASI 200x500mm

Ürün Kodu	Kısa Kod	Ölçü	Yükseklik	Fiyat
<b>BEYAZ</b>				
7120.050200.0.0	13657	200x500 mm	-	20
<b>SİYAH</b>				
7120.050200.0.S	26922	200x500 mm	-	20

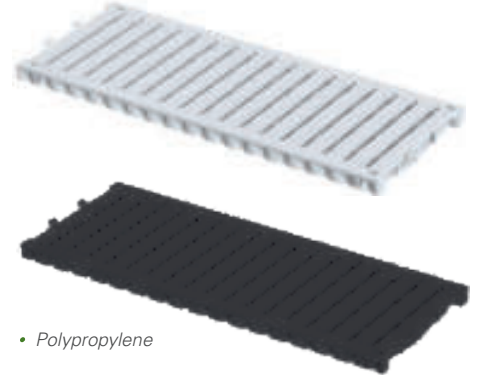

• Polypropylene

## PASLANMAZ KANAL IZGARASI 200x500mm

Ürün Kodu	Kısa Kod	Ölçü	Kalite	Desen	Fiyat
2120.05021P.304.2	13861	200x500 mm	S.S.304	Kare	733.40
2120.05021P.304.3	13851	200x500 mm	S.S.304	Çizgi	733.40
2120.05021P.304.4	13840	200x500 mm	S.S.304	Standart	730.00
2120.05021P.430.4	13849	200x500 mm	GALVANİZ	Standart	306.70



• Paslanmaz

## SFERO DÖKÜM KANAL IZGARASI 200x500mm

Ürün Kodu	Kısa Kod	Ölçü	Kalite	Desen	Fiyat
2120.05020D.000.4	18181	200x500 mm	Sfero Döküm	Standart	976.70



• Pisk Döküm

## KANAL TAPASI 200 mm

Ürün Kodu	Kısa Kod	Ölçü	Fiyat
<b>BEYAZ</b>			
7220.00120Y.0.0	13674	200x500 mm	150
<b>SİYAH</b>			
7220.00120Y.0.S	27083	200x500 mm	150



• Polypropylene  
• Ø 70 çıkış

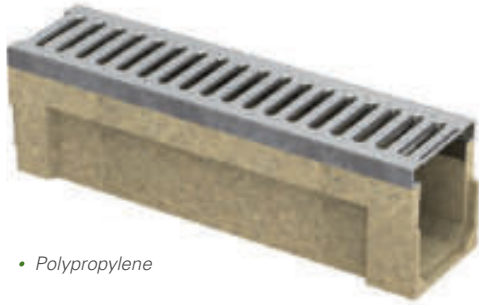

• Polypropylene

\* Alt Çıkışlar İsteğe Bağlıdır. Sipariş Esnasında Belirtiniz.  
\* Görseldeki Izgara birim fiyata dahil değildir.

**ÇİTALİ POLİMER KANAL**

Ürün Kodu	Kısa Kod	Ölçü	Yükseklik		Fiyat
<b>130 MM</b>					
2013.100K00.060.Ç	13682	130x1000 mm	60 mm	1	1216.70
2013.100K00.080.Ç	13684	130x1000 mm	80 mm	1	1323.40
2013.100K00.100.Ç	13686	130x1000 mm	100 mm	1	1430.00
2013.100K00.150.Ç	13687	130x1000 mm	150 mm	1	1643.40
<b>200 MM</b>					
2020.100K00.060.Ç	13695	200x1000 mm	60 mm	1	1376.70
2020.100K00.080.Ç	13696	200x1000 mm	80 mm	1	1510.00
2020.100K00.120.Ç	13697	200x1000 mm	120 mm	1	1696.70
2020.100K00.150.Ç	13698	200x1000 mm	150 mm	1	1833.40
2020.100K00.200.Ç	13699	200x1000 mm	200 mm	1	1993.40
2020.100K00.300.Ç	13700	200x1000 mm	300 mm	1	2553.40
2020.100K00.400.Ç	13701	200x1000 mm	400 mm	1	3570.00
<b>300 MM</b>					
2030.100K00.080.Ç	13704	300x1000 mm	80 mm	1	1860.00
2030.100K00.120.Ç	13705	300x1000 mm	120 mm	1	1966.70
2030.100K00.150.Ç	13706	300x1000 mm	150 mm	1	2260.00
2030.100K00.200.Ç	13707	300x1000 mm	200 mm	1	2473.40
2030.100K00.250.Ç	13708	300x1000 mm	250 mm	1	2713.40



• Polypropylene

**KANAL TAPASI**

Ürün Kodu	Kısa Kod	Ölçü	Yükseklik		Fiyat
<b>130 MM</b>					
2013.000T00.060.S	13711	130x60 mm	60 mm	1	243.40
2013.000T00.080.S	13713	130x80 mm	80 mm	1	243.40
2013.000T00.100.S	13715	130x100 mm	100 mm	1	243.40
2013.000T00.150.S	13717	130x150 mm	150 mm	1	273.40
2013.000T00.200.S	13718	130x200 mm	200 mm	1	273.40
<b>200 MM</b>					
2020.000T00.060.S	13719	200x60 mm	60 mm	1	243.40
2020.000T00.080.S	13720	200x80 mm	80 mm	1	243.40
2020.000T00.120.S	13721	200x120 mm	120 mm	1	290.00
2020.000T00.150.S	13722	200x150 mm	150 mm	1	290.00
2020.000T00.200.S	13723	200x200 mm	200 mm	1	323.40
2020.000T00.300.S	13724	200x300 mm	300 mm	1	360.00
2020.000T00.400.S	27542	200x400 mm	400 mm	1	396.70
<b>300 MM</b>					
2030.000T00.080.S	13725	300x80 mm	80 mm	1	360.00
2030.000T00.120.S	13726	300x120 mm	120 mm	1	360.00
2030.000T00.150.S	13727	300x150 mm	150 mm	1	360.00
2030.000T00.200.S	13728	300x200 mm	200 mm	1	423.40
2030.000T00.250.S	13729	300x250 mm	250 mm	1	423.40

**IZGARA DESEN SEÇENEKLERİ**



**PLASTİK**

- PP
- AISI 304
- AISI 430
- Galvaniz
- Sfero Döküm



**KARE**

- AISI 304
- AISI 430
- Galvaniz

## PASLANMAZ IZGARA 130 mm

Ürün Kodu	Kısa Kod	Ölçü	Kalite	Desen	Fiyat
<b>PASLANMAZ IZGARA 130x500 MM</b>					
2113.05020P.304.2	13811	130x500 mm	S.S.304	Kare	406.70
2113.05020P.304.4	13788	130x500 mm	S.S.304	Standart	330.00
<b>PASLANMAZ IZGARA 130x1000 MM</b>					
2113.10020P.304.2	13833	130x1000 mm	S.S.304	Kare	800.00
2113.10020P.304.4	13821	130x1000 mm	S.S.304	Standart	646.70
<b>GALVANİZ IZGARA</b>					
2113.05020P.430.4	13797	130x500 mm	Galvaniz	Standart	123.40
2113.10021P.430.4	13825	130x1000 mm	Galvaniz	Standart	233.40
<b>PİK DÖKÜM IZGARA</b>					
2113.05020D.000.4	18172	130x500 mm	Pik Döküm	Standart	616.70
<b>PASLANMAZ IZGARA 200x500 MM</b>					
2120.05021P.304.2	13861	200x500 mm	S.S.304	Kare	733.40
2120.05021P.304.3	13851	200x500 mm	S.S.304	Çizgi	733.40
2120.05021P.304.4	13840	200x500 mm	S.S.304	Standart	730.00
<b>GALVANİZ IZGARA</b>					
2120.05021P.430.4	13849	200x500 mm	Galvaniz	Standart	306.70
<b>PİK DÖKÜM IZGARA</b>					
2120.05020D.000.4	18181	200x500 mm	Pik Döküm	Standart	976.70
<b>PASLANMAZ IZGARA 300x500 MM</b>					
2130.05021P.304.4	13871	300x500 mm	S.S.304	Kare	1503.40
<b>PİK DÖKÜM IZGARA</b>					
2130.05020D.000.4	21862	300x500 mm	Pik Döküm	Standart	1700.00



• Paslanmaz



• Pik Döküm



• Paslanmaz



• Pik Döküm





**A.Ç. 15x15**

Ürün Kodu	Kısa Kod	Çıkış	Ölçü	Fiyat
<b>ALT ÇIKIŞ</b>				
2215.15A070.065.P	13737	Ø 70	15x15 cm	556.70

- Pik döküm gövde
- Pik ızgara
- Koku tutucu



**A.Ç. 20x20**

Ürün Kodu	Kısa Kod	Çıkış	Ölçü	Fiyat
<b>ALT ÇIKIŞ</b>				
2220.20A100.080.P	13739	Ø 100	20x20 cm	933.40

- Pik döküm gövde
- Pik ızgara
- Koku tutucu



**A.Ç. 30x30**

Ürün Kodu	Kısa Kod	Çıkış	Ölçü	Fiyat
<b>ALT ÇIKIŞ</b>				
2230.30A100.070.P	13741	Ø 100	30x30 cm	1950.00

- Pik döküm gövde
- Pik ızgara
- Koku tutucu



**PARAPET SÜZGEÇ**

Ürün Kodu	Kısa Kod	Çıkış	Fiyat
<b>2270.0A070.000.P</b>	<b>31354</b>	Ø 70	1950.00
<b>2270.0A100.000.P</b>	<b>31355</b>	Ø 100	1950.00

- Pik döküm gövde
- Paslanmaz ızgara
- Koku tutucu

**20x20 ÇAMUR SIFON**



- Ø 70 yan - alt çıkış
- Plastik gövde
- Plastik ızgara

Ürün Kodu	Kısa Kod	Çıkış	Ölçü	Fiyat	
<b>YAN ÇIKIŞ</b>					
1101.2020Y0.070.0	13748	Ø 70	20x20 cm	30	110.00
<b>ALT ÇIKIŞ</b>					
1101.2020A0.070.0	13750	Ø 70	20x20 cm	30	103.40

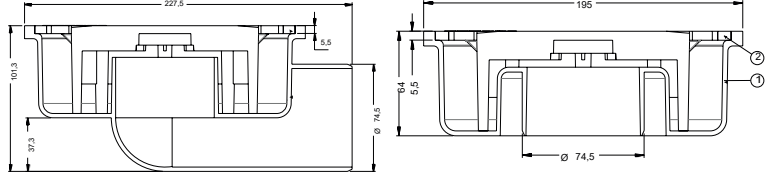

**25x25 ÇAMUR SIFON**



- Ø 100 yan - alt çıkış
- Plastik gövde
- Plastik ızgara

Ürün Kodu	Kısa Kod	Çıkış	Ölçü	Fiyat	
<b>YAN ÇIKIŞ</b>					
1101.2525Y0.100.0	13755	Ø 100	25x25 cm	20	160.00
<b>ALT ÇIKIŞ</b>					
1101.2525A0.100.0	13756	Ø 100	25x25 cm	20	140.00

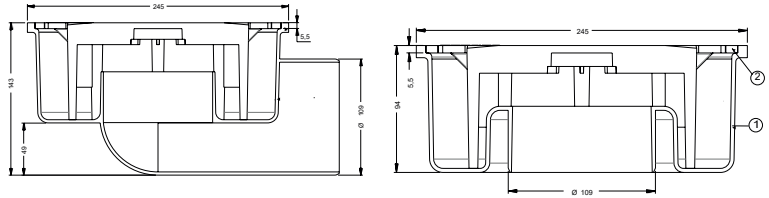

**RÖGAR KAPAK TAKIMI**



- Plastik gövde
- Plastik çerçeve

Ürün Kodu	Kısa Kod	Ölçü	Fiyat	
2601.222200.141.T	13758	22x22 cm	1	66.70
2601.333300.142.T	13760	33x33 cm	1	120.00
2601.393900.146.T	13763	39x39 cm	1	223.40



**ENGELLI  
SERİSİ**



## TUTUNMA BARI Ø 19

Ürün Kodu	Kısa Kod	Ölçü	Kalite		Fiyat
4819.1920P304.00	13549	8.5x20 cm	S.S. 304	1	163.40
4819.1930P304.00	13556	8.5x30 cm	S.S. 304	1	180.00
4819.1940P304.00	13557	8.5x40 cm	S.S. 304	1	196.70
4819.1950P304.00	13559	8.5x50 cm	S.S. 304	1	213.40
4819.1960P304.00	13560	8.5x60 cm	S.S. 304	1	230.00

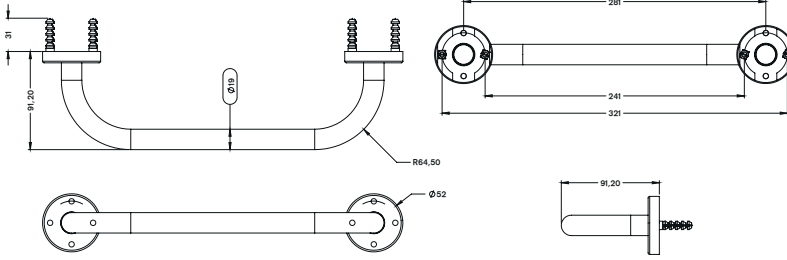

## TUTUNMA BARI Ø 25

Ürün Kodu	Kısa Kod	Ölçü	Kalite		Fiyat
4819.2520P304.00	13561	8.5x20 cm	S.S. 304	1	193.40
4819.2530P304.00	13562	8.5x30 cm	S.S. 304	1	216.70
4819.2540P304.00	13563	8.5x40 cm	S.S. 304	1	233.40
4819.2550P304.00	13564	8.5x50 cm	S.S. 304	1	256.70
4819.2560P304.00	13565	8.5x60 cm	S.S. 304	1	280.00

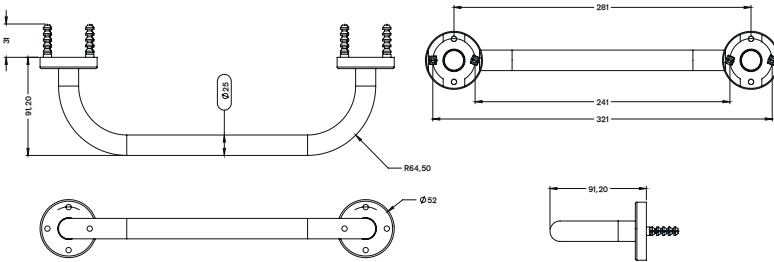

## TUTUNMA BARI Ø 32

Ürün Kodu	Kısa Kod	Ölçü	Kalite		Fiyat
4819.3230P304.00	13566	10.5x30 cm	S.S. 304	1	306.70
4819.3240P304.00	13567	10.5x40 cm	S.S. 304	1	336.70
4819.3250P304.00	13568	10.5x50 cm	S.S. 304	1	366.70
4819.3260P304.00	13569	10.5x60 cm	S.S. 304	1	400.00

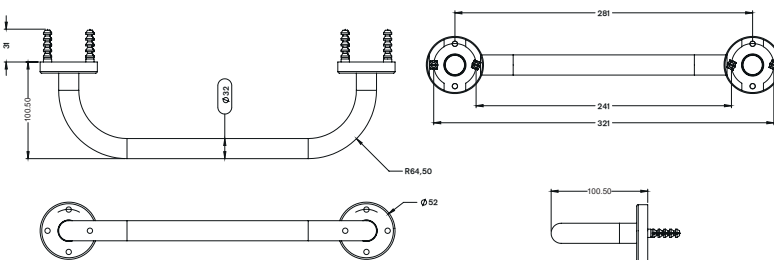



**AÇILI TUTUNMA BARI**

Ürün Kodu	Kısa Kod	Çap	Ölçü	Kalite	Fiyat
4826.1950P304.00	13570	Ø 19	13x40x8.5 cm	S.S. 304	206.70
4826.2564P304.00	13571	Ø 25	13x44x8.5 cm	S.S. 304	263.40
4826.3264P304.00	13572	Ø 32	22x64x10 cm	S.S. 304	410.00

**AÇILI SÜNGERLİ TUTUNMA BARI**

Ürün Kodu	Kısa Kod	Çap	Ölçü	Kalite	Fiyat
4827.1950P304.00	13573	Ø 19	13x40x10 cm	S.S. 304	396.70
4827.2550P304.00	13574	Ø 25	13x44x10 cm	S.S. 304	450.00



**LAVABO TUTUNMA BARI**

Ürün Kodu	Kısa Kod	Çap	Ölçü	Kalite	Fiyat
4838.7080P304.00	13575	Ø 32	76x74x80 cm	S.S. 304	2683.40



**MAFSALLI AYAKLI**

Ürün Kodu	Kısa Kod	Çap	Ölçü	Kalite	Fiyat
4828.7611P304.00	13576	Ø 32	75x73 cm	S.S. 304	2036.70



## MAFSALLI STANDART

Ürün Kodu	Kısa Kod	Çap	Ölçü	Kalite	Fiyat
<b>SS 304</b>					
4832.2311P.304.00	13578	Ø 32	73x24x11 cm	SS 304	1 830.00
<b>RENKLİ</b>					
4832.2311B.101.00	28808	Ø 32	73x24x11 cm	BEYAZ	1 673.40
4832.2311S.102.00	28809	Ø 32	73x24x11 cm	SIYAH	1 673.40

• Tutunma barı

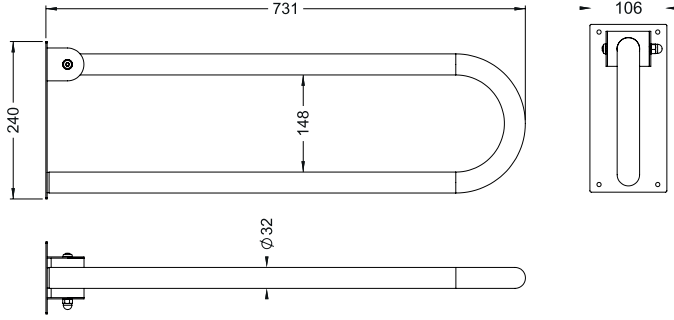

## MAFSALLI WC KAĞITLIKLİ

Ürün Kodu	Kısa Kod	Çap	Ölçü	Kalite	Fiyat
<b>SS 304</b>					
4833.2311P.304.00	13579	Ø 32	73x24x11 cm	SS 304	1 860.00
<b>RENKLİ</b>					
4833.2311B.101.00	28810	Ø 32	73x24x11 cm	BEYAZ	1 720.00
4833.2311S.102.00	28811	Ø 32	73x24x11 cm	SIYAH	1 720.00

• Tutunma barı

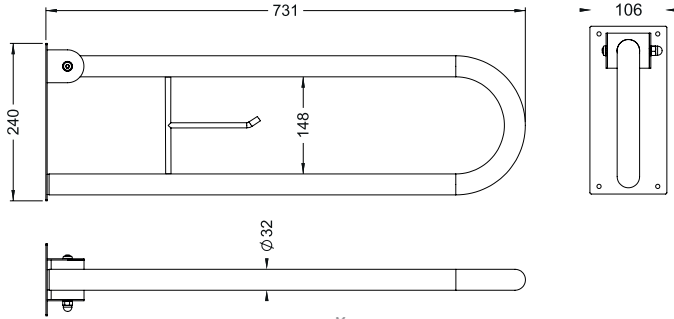

## MAFSALLI WC KAĞITLIKLİ

Ürün Kodu	Kısa Kod	Çap	Ölçü	Kalite	Fiyat
<b>SS 304</b>					
4835.2311P.304.00	13580	Ø 32	73x24x11 cm	SS 304	1 920.00
<b>RENKLİ</b>					
4835.2311B.101.00	28812	Ø 32	73x24x11 cm	BEYAZ	1 740.00
4835.2311S.102.00	28813	Ø 32	73x24x11 cm	SIYAH	1 740.00

• Tutunma barı

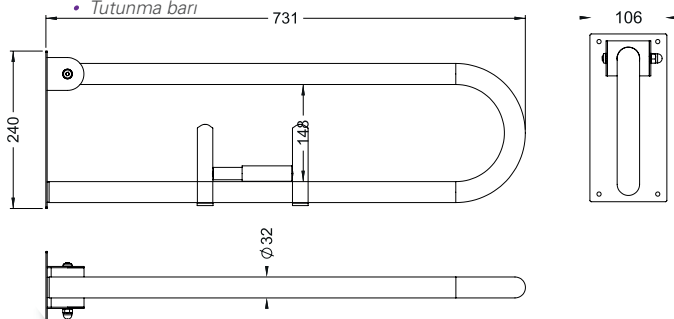



**YERDEN DUVARA**

Ürün Kodu	Kısa Kod	Çap	Ölçü	Kalite	Fiyat
<b>SS 304</b>					
4834.7500P.304.00	13581	Ø 32	75x75 cm	SS 304	540.00

• Tutunma bari

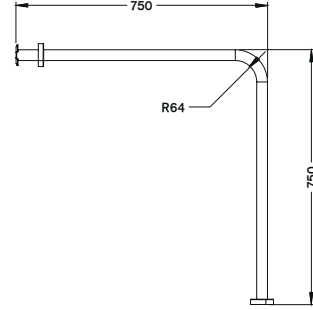

**YERDEN DUVARA BASTON AYAK**

Ürün Kodu	Kısa Kod	Çap	Ölçü	Kalite	Fiyat
<b>SS 304</b>					
4836.7500P.304.00	13582	Ø 32	75x75x30 cm	SS 304	740.00

• Tutunma bari

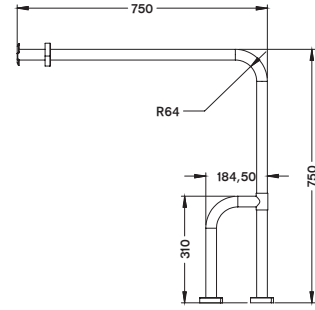

**AÇILI TUTUNMA BARI KÖŞE**

Ürün Kodu	Kısa Kod	Çap	Ölçü	Kalite	Fiyat
<b>SS 304</b>					
4831.4012P.304.00	13583	Ø 32	80x40x12 cm	SS 304	636.70

• Tutunma bari

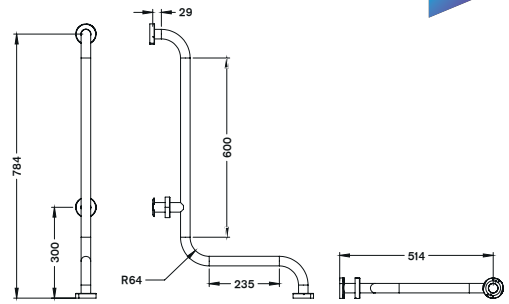

**L TİPİ TUTUNMA BARI**

Ürün Kodu	Kısa Kod	Çap	Ölçü	Kalite	Fiyat
<b>SS 304</b>					
4837.4012P.304.00	13584	Ø 32	80x40x12 cm	SS 304	636.70

• Tutunma bari

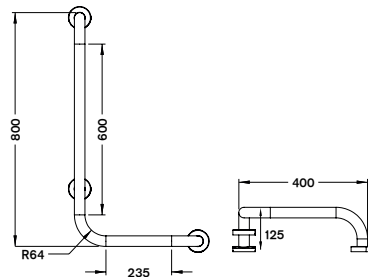

## PLASTİK ENGELLİ DUŞ OTURAĞI



Ürün Kodu	Kısa Kod	Çap	Ölçü	Kalite	Fiyat
<b>SS 304</b>					
4820.4043S.304.00	13585	Ø 19	43x41.5x39.5 cm	SS 304 5	1.076.70

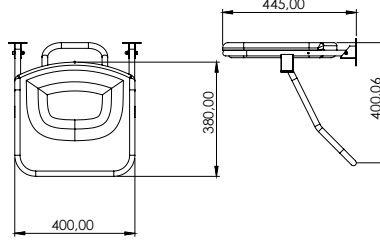

## AHŞAP ENGELLİ DUŞ OTURAĞI



Ürün Kodu	Kısa Kod	Çap	Ölçü	Kalite	Fiyat
<b>SS 304</b>					
4820.4041S.304.00	13586	Ø 19	46x43.5x39 cm	SS 304 5	1416.70

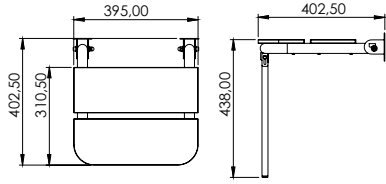

## ENGELLİ AYNASI



Ürün Kodu	Kısa Kod	Ölçü	Kalite	Fiyat
<b>SS 304</b>				
4821.5070S.304.00	13587	50x70 cm	SS 304 5	943.40

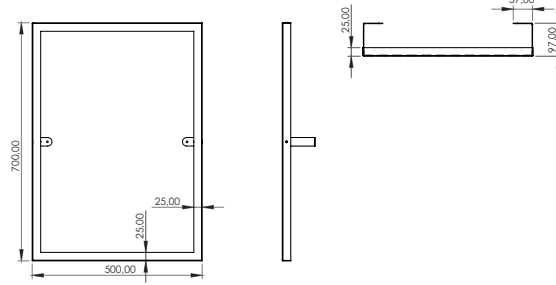

## KULPLU ENGELLİ AYNASI



Ürün Kodu	Kısa Kod	Ölçü	Kalite	Fiyat
<b>SS 304</b>				
4840.5070S.304.00	13588	50x70 cm	SS 304 5	1.036.70

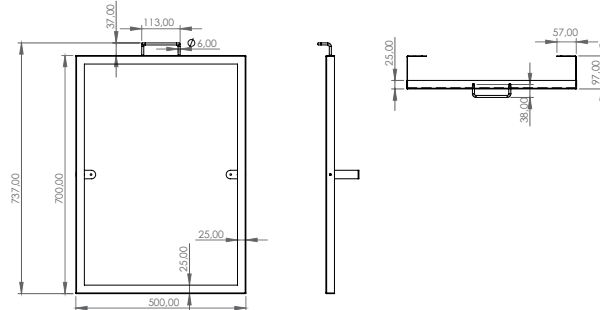

# ÇÖP KOVALARI



# PEDALLI ÇÖP KOVALARI

**MAXIFLOW**  
Maksimum akış...

## MICRO

Ürün Kodu	Kısa Kod	Çap	Yükseklik	Kalite	İkili	Fiyat
<b>SS 430</b>						
4501.1725M.430.03	13210	3 L Ø 17	24 cm	S.S. 430	8	196.70
4501.1825M.430.05	13212	5 L Ø 21	22 cm	S.S. 430	8	236.70



- Paslanmaz gövde
- Pedallı

## STANDART PEDALLI ÇÖP KOVASI

Ürün Kodu	Kısa Kod	Çap	Yükseklik	Kalite	İkili	Fiyat
<b>SS 430</b>						
4501.1825S.430.03	13231	3 L Ø 21	22 cm	S.S. 430	8	236.70
4501.2028S.430.05	13234	5 L Ø 21	26 cm	S.S. 430	8	280.00
4501.2035S.430.08	13235	8 L Ø 21	35 cm	S.S. 430	6	343.40
4501.2435S.430.12	13236	12 L Ø 25	35 cm	S.S. 430	6	386.70
4501.2444S.430.16	13237	16 L Ø 25	44 cm	S.S. 430	4	546.70
4501.3135S.430.20	13238	20 L Ø 31	36 cm	S.S. 430	4	663.35
4501.3144S.430.30	13239	30 L Ø 31	45 cm	S.S. 430	4	746.70
4501.3163S.430.40	13240	40 L Ø 31	63 cm	S.S. 430	4	980.00
<b>SS 304</b>						
4501.1825S.304.03	13241	3 L Ø 21	22 cm	S.S. 304	8	340.00
4501.2028S.304.05	13242	5 L Ø 21	26 cm	S.S. 304	8	386.70
4501.2035S.304.08	13243	8 L Ø 21	35 cm	S.S. 304	6	460.00
4501.2435S.304.12	13248	12 L Ø 25	35 cm	S.S. 304	6	516.70



- Paslanmaz gövde
- Pedallı

## STANDART BOYALI ÇÖP KOVASI

Ürün Kodu	Kısa Kod	Çap	Yükseklik	İkili	Fiyat
<b>BEYAZ</b>					
4501.1825S.101.03	18199	3 L Ø 21	22 cm	8	243.40
4501.2028S.101.05	18204	5 L Ø 21	26 cm	8	256.70
4501.2035S.101.08	19855	8 L Ø 21	35 cm	6	300.00
4501.2435S.101.12	18208	12 L Ø 25	35 cm	6	373.40
4501.2444S.101.16	27520	16 L Ø 25	44 cm	4	493.40
4501.3135S.101.20	26002	20 L Ø 31	36 cm	4	623.40
4501.3144S.101.30	27526	30 L Ø 31	45 cm	4	703.40
4501.3163S.101.40	27532	40 L Ø 31	63 cm	4	903.40
<b>SİYAH</b>					
4501.1825S.102.03	18197	3 L Ø 21	22 cm	8	243.40
4501.2028S.102.05	18202	5 L Ø 21	26 cm	8	256.70
4501.2035S.102.08	19858	8 L Ø 21	35 cm	6	300.00
4501.2435S.102.12	18207	12 L Ø 25	35 cm	6	373.40
4501.2444S.102.16	27523	16 L Ø 25	44 cm	4	493.40
4501.3135S.102.20	26005	20 L Ø 31	36 cm	4	623.40
4501.3144S.102.30	27528	30 L Ø 31	45 cm	4	703.40
4501.3163S.102.40	27534	40 L Ø 31	63 cm	4	903.40
<b>ANTRASİT</b>					
4501.1825S.110.03	31435	3 L Ø 21	22 cm	8	279.90
4501.2028S.110.05	31436	5 L Ø 21	26 cm	8	295.20
4501.2035S.110.08	31437	8 L Ø 21	35 cm	6	345.00
4501.2435S.110.12	31438	12 L Ø 25	35 cm	6	429.40
4501.2444S.110.16	31439	16 L Ø 25	44 cm	4	567.40
4501.3135S.110.20	31440	20 L Ø 31	36 cm	4	716.90
4501.3144S.110.30	31441	30 L Ø 31	45 cm	4	808.40
4501.3163S.110.40	31442	40 L Ø 31	63 cm	4	1038.90



Ürünlerimiz  göre üretilmiştir.

**AMORTİSÖRLÜ KAPAK**



- Paslanmaz gövde
- Pedallı

Ürün Kodu	Kısa Kod	Çap	Yükseklik	Kalite	Fiyat
<b>SS 430</b>					
4501.1825Y.430.03	13249	3 L Ø 21	22 cm	S.S. 430	8 290.00
4501.2028Y.430.05	13250	5 L Ø 21	26 cm	S.S. 430	8 313.35
4501.2035Y.430.08	13254	8 L Ø 21	35 cm	S.S. 430	6 376.70
4501.2435Y.430.12	13255	12 L Ø 25	35 cm	S.S. 430	6 420.00
4501.2444Y.430.16	13268	16 L Ø 25	44 cm	S.S. 430	4 543.35
4501.3135Y.430.20	21355	20 L Ø 31	36 cm	S.S. 430	4 693.35
4501.3144Y.430.30	21356	30 L Ø 31	45 cm	S.S. 430	4 806.70
4501.3163Y.430.40	21357	40 L Ø 31	63 cm	S.S. 430	4 1050.00
<b>SS 304</b>					
4501.1825Y.304.03	13256	3 L Ø 21	22 cm	S.S. 304	8 390.00
4501.2028Y.304.05	13260	5 L Ø 21	26 cm	S.S. 304	8 440.00
4501.2035Y.304.08	13261	8 L Ø 21	35 cm	S.S. 304	6 506.70
4501.2435Y.304.12	13262	12 L Ø 25	35 cm	S.S. 304	6 586.70

**BOMBE KAPAK**

- Paslanmaz gövde
- Pedallı



Ürün Kodu	Kısa Kod	Çap	Yükseklik	Kalite	Fiyat
<b>SS 430</b>					
4516.1825S.430.03	30816	3 L Ø 21	21 cm	S.S. 430	8 316.70
4516.2028S.430.05	30817	5 L Ø 21	27 cm	S.S. 430	8 340.00
4516.2035S.430.08	30818	8 L Ø 21	36 cm	S.S. 430	6 400.00
4516.2435S.430.12	30819	12 L Ø 25	36 cm	S.S. 430	6 450.00
4516.2444S.430.16	30820	16 L Ø 25	45 cm	S.S. 430	4 630.00
4516.3135S.430.20	30821	20 L Ø 31	37 cm	S.S. 430	4 743.40
4516.3144S.430.30	30822	30 L Ø 31	46 cm	S.S. 430	4 836.70
4516.3163S.430.40	30823	40 L Ø 31	64 cm	S.S. 430	4 1096.70
<b>BEYAZ</b>					
4516.1825S.101.03	30824	3 L Ø 21	21 cm		8 313.40
4516.2028S.101.05	30825	5 L Ø 21	27 cm		8 330.00
4516.2035S.101.08	30826	8 L Ø 21	36 cm		6 376.70
4516.2435S.101.12	30827	12 L Ø 25	36 cm		6 443.40
4516.2444S.101.16	30828	16 L Ø 25	45 cm		4 580.00
4516.3135S.101.20	30829	20 L Ø 31	37 cm		4 720.00
4516.3144S.101.30	30830	30 L Ø 31	46 cm		4 806.70
4516.3163S.101.40	30831	40 L Ø 31	64 cm		4 1033.40
<b>SİYAH</b>					
4516.1825S.102.03	30832	3 L Ø 21	21 cm		8 313.40
4516.2028S.102.05	30833	5 L Ø 21	27 cm		8 330.00
4516.2035S.102.08	30834	8 L Ø 21	36 cm		6 376.70
4516.2435S.102.12	30835	12 L Ø 25	36 cm		6 443.40
4516.2444S.102.16	30836	16 L Ø 25	45 cm		4 580.00
4516.3135S.102.20	30837	20 L Ø 31	37 cm		4 720.00
4516.3144S.102.30	30838	30 L Ø 31	46 cm		4 806.70
4516.3163S.102.40	30839	40 L Ø 31	64 cm		4 1033.40
<b>ANTRASİT</b>					
4516.1825S.110.03	31420	3 L Ø 21	21 cm		8 360.40
4516.2028S.110.05	31421	5 L Ø 21	27 cm		8 379.50
4516.2035S.110.08	31422	8 L Ø 21	36 cm		6 433.20
4516.2435S.110.12	31423	12 L Ø 25	36 cm		6 509.90
4516.2444S.110.16	31424	16 L Ø 25	45 cm		4 667.00
4516.3135S.110.20	31425	20 L Ø 31	37 cm		4 828.00
4516.3144S.110.30	31426	30 L Ø 31	46 cm		4 927.70
4516.3163S.110.40	31427	40 L Ø 31	64 cm		4 1188.40



**PRATİK KAPAK**

Ürün Kodu	Kısa Kod	Çap	Yükseklik	Kalite	Fiyat
<b>SS 430</b>					
4513.0000S.430.05	13269	5 L Ø 21	26 cm	S.S. 430 8	356.70
4513.0000S.430.08	13271	8 L Ø 21	32 cm	S.S. 430 8	450.00
4513.0000S.430.12	13272	12 L Ø 25	32 cm	S.S. 430 6	566.70
4513.0000S.430.16	13274	16 L Ø 25	38.5 cm	S.S. 430 6	606.70
4513.0000S.430.20	13275	20 L Ø 25	46.5 cm	S.S. 430 6	653.40
4513.0000S.430.27	13276	27 L Ø 25	57 cm	S.S. 430 6	730.00
4513.0000S.430.32	13277	32 L Ø 31	46 cm	S.S. 430 4	883.40
4513.0000S.430.45	13278	45 L Ø 31	57 cm	S.S. 430 4	996.70
<b>RENKLİ</b>					
4513.0000B.101.08	28655	8 L Ø 21	32 cm	BEYAZ 8	436.70
4513.0000S.102.08	28656	8 L Ø 21	32 cm	SİYAH 8	436.70
4513.0000B.101.27	28660	27 L Ø 25	57 cm	BEYAZ 6	710.00
4513.0000S.102.27	28661	27 L Ø 25	57 cm	SİYAH 6	710.00
4513.0000B.101.45	28665	45 L Ø 31	57 cm	BEYAZ 4	976.70
4513.0000S.102.45	28666	45 L Ø 31	57 cm	SİYAH 4	976.70



• Paslanmaz gövde



**PRATİK ÇEMBERLİ**

Ürün Kodu	Kısa Kod	Çap	Yükseklik	Kalite	Fiyat
<b>SS 430</b>					
4514.0000S.430.05	13279	5 L Ø 21	26 cm	S.S. 430 8	346.70
4514.0000S.430.08	13280	8 L Ø 21	32 cm	S.S. 430 8	380.00
4514.0000S.430.12	13281	12 L Ø 25	32 cm	S.S. 430 6	476.70
4514.0000S.430.16	13282	16 L Ø 25	38.5 cm	S.S. 430 6	516.70
4514.0000S.430.20	13283	20 L Ø 25	46.5 cm	S.S. 430 6	586.70
4514.0000S.430.27	13284	27 L Ø 25	57 cm	S.S. 430 6	656.70
4514.0000S.430.32	13285	32 L Ø 31	46 cm	S.S. 430 4	800.00
4514.0000S.430.45	13286	45 L Ø 31	57 cm	S.S. 430 4	946.70
<b>RENKLİ</b>					
4514.0000B.101.08	28670	8 L Ø 21	32 cm	BEYAZ 8	356.70
4514.0000S.102.08	28671	8 L Ø 21	32 cm	SİYAH 8	356.70
4514.0000B.101.27	28675	27 L Ø 25	57 cm	BEYAZ 6	640.00
4514.0000S.102.27	28676	27 L Ø 25	57 cm	SİYAH 6	640.00
4514.0000B.101.45	28680	45 L Ø 31	57 cm	BEYAZ 4	923.40
4514.0000S.102.45	28681	45 L Ø 31	57 cm	SİYAH 4	923.40



**KULPLU ÇÖP KOVASI**

Ürün Kodu	Kısa Kod	Çap	Yükseklik	Kalite	Fiyat
<b>SS 430</b>					
4502.2028S.430.05	29856	5 L Ø 21	26 cm	S.S. 430 8	303.40





- Paslanmaz gövde
- Kapaksız



- Paslanmaz gövde
- Paslanmaz kapak



- Paslanmaz gövde
- Paslanmaz kapak



- Paslanmaz gövde
- Kapaksız

## KAPAKSIZ

Ürün Kodu	Kısa Kod	Çap	Yükseklik	Kalite	Fiyat
<b>SS 430</b>					
4503.1823S.430.03	13288	3 L Ø 21	19.5 cm	S.S. 430	8 173.40
4503.2026S.430.05	13289	5 L Ø 21	24 cm	S.S. 430	8 193.40
4503.2033S.430.08	13290	8 L Ø 21	33 cm	S.S. 430	6 253.40
4503.2433S.430.12	13291	12 L Ø 25	33 cm	S.S. 430	6 296.70
4503.2441S.430.16	13292	16 L Ø 25	42 cm	S.S. 430	4 376.70
<b>SS 304</b>					
4503.1823S.304.03	13293	3 L Ø 21	19.5 cm	S.S. 304	8 220.00
4503.2026S.304.05	13294	5 L Ø 21	24 cm	S.S. 304	8 246.70
4503.2035S.304.08	13295	8 L Ø 21	33 cm	S.S. 304	6 326.70
4503.2435S.304.12	13296	12 L Ø 25	33 cm	S.S. 304	6 383.40

## ÇEMBERLİ

Ürün Kodu	Kısa Kod	Çap	Yükseklik	Kalite	Fiyat
<b>SS 430</b>					
4504.1924S.430.03	13298	3 L Ø 21	20.5 cm	S.S. 430	8 246.70
4504.2127S.430.05	13299	5 L Ø 21	24 cm	S.S. 430	8 266.70
4504.2034S.430.08	13300	8 L Ø 21	33 cm	S.S. 430	6 323.40
4504.2434S.430.12	13301	12 L Ø 25	33 cm	S.S. 430	6 386.70
4504.2442S.430.16	13302	16 L Ø 25	42 cm	S.S. 430	4 466.70
<b>SS 304</b>					
4504.1924S.304.03	13303	3 L Ø 21	20.5 cm	S.S. 304	8 316.70
4504.2127S.304.05	13304	5 L Ø 21	24 cm	S.S. 304	8 343.40
4504.2034S.304.08	13305	8 L Ø 21	33 cm	S.S. 304	6 410.00
4504.2434S.304.12	13306	12 L Ø 25	33 cm	S.S. 304	6 506.70

## YANMAZ

Ürün Kodu	Kısa Kod	Çap	Yükseklik	Kalite	Fiyat
<b>SS 430</b>					
4507.2125S.430.08	13330	8 L Ø 21	25 cm	S.S. 430	8 293.40

## OFİS TİPİ

Ürün Kodu	Kısa Kod	Çap	Yükseklik	Kalite	Fiyat
<b>SS 430</b>					
4506.2529S.000.00	13329	8 L Ø 21	23.5 cm	S.S. 430	8 233.40

**LÜKS KARE PEDALLI ÇÖP KOVASI**

Ürün Kodu	Kısa Kod	Ölçü	Fiyat
<b>SS 430</b>			
4511.3040S.430.00	29718	24x28x50 cm	1.380.00
<b>RENKLİ</b>			
4511.3040B.101.00	29719	BEYAZ 24x28x50 cm	1.330.00
4511.3040S.102.00	29720	SİYAH 24x28x50 cm	1.330.00



**DÜZ KAPAK**

Ürün Kodu	Kısa Kod	Yükseklik	Kalite	Fiyat
<b>SS 430</b>				
4513.2860S.430.0	13326 Ø 27	59.5 cm	S.S. 430	730.00
<b>BEYAZ</b>				
4513.2860S.101.B	28730 Ø 27	59.5 cm		716.70
<b>SİYAH</b>				
4513.2860S.102.S	28731 Ø 27	59.5 cm		716.70



**BOMBE KAPAK**

Ürün Kodu	Kısa Kod	Yükseklik	Kalite	Fiyat
<b>SS 430</b>				
4512.2867S.000.00	13327 Ø 27	62 cm	S.S. 430	730.00
<b>BEYAZ</b>				
4512.2867S.101.B	28735 Ø 27	62 cm		716.70
<b>SİYAH</b>				
4512.2867S.102.S	28736 Ø 27	62 cm		716.70



**SALLANIR KAPAK**



Ürün Kodu	Kısa Kod	Yükseklik	Kalite	Fiyat
<b>SS 430</b>				
4508.1528S.430.07	13309	7 L 15x17x27 cm	S.S. 430	433.40
4508.1839S.430.11	13310	11 L 18x20x38 cm	S.S. 430	666.70
4508.1850S.430.16	13311	16 L 18x20x49 cm	S.S. 430	840.00
4508.2448S.430.25	13312	25 L 24x28x50 cm	S.S. 430	1.176.70
4508.2463S.430.36	13313	36 L 24x28x65 cm	S.S. 430	1.363.40
4508.3055S.430.45	13314	45 L 30x35x55 cm	S.S. 430	1.570.00
4508.3061S.430.54	13315	54 L 30x34x62 cm	S.S. 430	1.723.40
4508.3089S.430.80	13316	80 L 30x35x90 cm	S.S. 430	2.093.40

**BEYAZ**

4508.1528B.101.07	28685	7 L 15x17x27 cm		393.40
4508.1839B.101.11	28690	11 L 18x20x38 cm		600.00
4508.1850B.101.16	28695	16 L 18x20x49 cm		766.70
4508.2448B.101.25	28700	25 L 24x28x50 cm		1.076.70
4508.2463B.101.36	28705	36 L 24x28x65 cm		1.236.70
4508.3055B.101.45	28710	45 L 30x35x55 cm		1.410.00
4508.3061B.101.54	28715	54 L 30x34x62 cm		1.526.70
4508.3089B.101.80	28720	80 L 30x35x90 cm		1.950.00

**RENKLİ SİYAH**

4508.1528S.102.07	28686	7 L 15x17x27 cm		393.40
4508.1839S.102.11	28691	11 L 18x20x38 cm		600.00
4508.1850S.102.16	28696	16 L 18x20x49 cm		766.70
4508.2448S.102.25	28701	25 L 24x28x50 cm		1.076.70
4508.2463S.102.36	28706	36 L 24x28x65 cm		1.236.70
4508.3055S.102.45	28711	45 L 30x35x55 cm		1.410.00
4508.3061S.102.54	28716	54 L 30x34x62 cm		1.526.70
4508.3089S.102.80	28721	80 L 30x35x90 cm		1.950.00

**ZARF TİPİ**



Ürün Kodu	Kısa Kod	Yükseklik	Kalite	Fiyat
<b>SS 430</b>				
4509.3090S.430.80	28725	80 L 30x35x90 cm	S.S. 430	2.073.40
<b>RENKLİ BEYAZ</b>				
4509.3090B.101.80	28727	80 L 30x35x90 cm		1.946.70
<b>RENKLİ SİYAH</b>				
4509.3090S.102.80	28728	80 L 30x35x90 cm		1.946.70

**AÇIK KAPAK**



Ürün Kodu	Kısa Kod	Yükseklik	Fiyat
<b>SS 430</b>			
4510.2463S.430.36	28795	36 L 42 cm	1150.00
<b>BEYAZ</b>			
4510.2463B.101.36	28790	36 L 42 cm	1096.70
<b>SİYAH</b>			
4510.2463S.102.36	28791	36 L 42 cm	1096.70

\*Boyalı ürünlerde 500 Adet ve üzeri siparişlerde özel renk seçenekleri mevcuttur.

**BORU TİPİ KÜLLÜK**

Ürün Kodu	Kısa Kod	Çap	Yükseklik	Kalite	Fiyat
<b>SS 304</b>					
4418.1182S.304.00	18182	Ø 10.50	83 cm	S.S. 304	2.000.00
<b>BEYAZ</b>					
4418.1182B.101.00	28780	Ø 10.50	83 cm		1670.00
<b>SİYAH</b>					
4418.1182S.102.00	28781	Ø 10.50	83 cm		1670.00



**DEKORATİF KÜLLÜK MİNİ**

Ürün Kodu	Kısa Kod	Çap	Yükseklik	Kalite	Fiyat
<b>MİNİ</b>					
4419.0709M.304.00	26457	Ø 7	9 cm	S.S. 304	160.00
4419.0709M.430.00	31410	Ø 7	9 cm	S.S. 430	113.40
<b>MAXİ</b>					
4419.0712M.304.00	26456	Ø 7	12 cm	S.S. 304	203.40
4419.0712M.430.00	31411	Ø 7	12 cm	S.S. 430	143.40
<b>RENKLİ MİNİ</b>					
4419.0709M.101.00	28775	Ø 7	9 cm	BEYAZ	93.40
4419.0709M.102.00	28776	Ø 7	9 cm	SİYAH	93.40
<b>RENKLİ MAXİ</b>					
4419.0712M.101.00	28770	Ø 7	12 cm	BEYAZ	113.40
4419.0712M.102.00	28771	Ø 7	12 cm	SİYAH	113.40





### SET ÜSTÜ SIVI SABUNLUK

Ürün Kodu	Kısa Kod	Renk	Çap	Yükseklik	Fiyat	
<b>PASLANMAZ SS 430</b>						
4711.17.718.1	26460		Ø 7	17 cm	20	120.00
<b>RENKLİ</b>						
4711.18.71.B	26464	BEYAZ	Ø 7	17 cm	20	116.70
4711.18.71.S	26463	SİYAH	Ø 7	17 cm	20	116.70
4711.18.71.P	26462	PEMBE	Ø 7	17 cm	20	116.70
4711.18.71.K	26461	KIRMIZI	Ø 7	17 cm	20	116.70
4711.18.71.M	26671	MOR	Ø 7	17 cm	20	116.70



### DİŞ FIRÇALIK

Ürün Kodu	Kısa Kod	Renk	Çap	Yükseklik	Fiyat	
<b>PASLANMAZ SS 430</b>						
4711.22.711.1	26455		Ø 7	12 cm	20	73.40
<b>RENKLİ</b>						
4711.22.711.B	26454	BEYAZ	Ø 7	12 cm	20	70.00
4711.22.711.S	26453	SİYAH	Ø 7	12 cm	20	70.00
4711.22.711.P	26452	PEMBE	Ø 7	12 cm	20	70.00
4711.22.711.K	26451	KIRMIZI	Ø 7	12 cm	20	70.00
4711.22.711.M	26672	MOR	Ø 7	12 cm	20	70.00



### STANDART

Ürün Kodu	Kısa Kod	Renk	Fiyat
<b>SS 430 2'Lİ SET</b>			
ST.0102.430.P	26441		370.00
<b>BOYALI 2'Lİ SET</b>			
ST.0402.101.B	26446	BEYAZ	346.70
ST.0302.102.S	26445	SİYAH	346.70
ST.0202.103.P	26444	PEMBE	346.70
ST.0102.104.K	26443	KIRMIZI	346.70
ST.0502.105.M	26669	MOR	346.70



### STANDART

Ürün Kodu	Kısa Kod	Renk	Fiyat
<b>SS 430 4'LÜ SET</b>			
ST.0104.430.P	26442		526.70
<b>BOYALI 4'LÜ SET</b>			
ST.0404.101.B	26450	BEYAZ	506.70
ST.0304.102.S	26449	SİYAH	506.70
ST.0204.103.P	26448	PEMBE	506.70
ST.0104.104.K	26447	KIRMIZI	506.70
ST.0504.105.M	26670	MOR	506.70

**STANDART KOLON KÜLLÜK**

Ürün Kodu	Kısa Kod	Çap	Yükseklik		Fiyat
<b>SS 430</b>					
4418.1960S.430.00	13333	Ø 19	60 cm	S.S. 430	8 496.70
4418.2160S.430.00	13334	Ø 21	60 cm	S.S. 430	8 540.00
4418.2560S.430.00	13335	Ø 25	60 cm	S.S. 430	6 666.70
4418.2860S.430.00	13336	Ø 28	60 cm	S.S. 430	4 800.00
<b>RENKLİ NO1</b>					
4418.1960B.101.00	28740	Ø 19	60 cm	BEYAZ	8 483.40
4418.1960S.102.00	28741	Ø 19	60 cm	SİYAH	8 483.40
<b>RENKLİ NO2</b>					
4418.2160B.101.00	28745	Ø 21	60 cm	BEYAZ	8 526.70
4418.2160S.102.00	28746	Ø 21	60 cm	SİYAH	8 526.70
<b>RENKLİ NO3</b>					
4418.2560B.101.00	28750	Ø 25	60 cm	BEYAZ	6 663.40
4418.2560S.102.00	28751	Ø 25	60 cm	SİYAH	6 663.40
<b>RENKLİ NO4</b>					
4418.2860B.101.00	28755	Ø 28	60 cm	BEYAZ	4 783.40
4418.2860S.102.00	28756	Ø 28	60 cm	SİYAH	4 783.40



**LÜKS KOLON KÜLLÜK**

Ürün Kodu	Kısa Kod	Çap	Yükseklik		Fiyat
<b>SS 430</b>					
4417.1960S.430.00	29702	Ø 19	60 cm	S.S. 430	8 630.00
4417.2160S.430.00	29703	Ø 21	60 cm	S.S. 430	8 686.70
4417.2560S.430.00	29704	Ø 25	60 cm	S.S. 430	6 866.70
4417.2860S.430.00	29705	Ø 28	60 cm	S.S. 430	4 1046.70
<b>RENKLİ NO1</b>					
4417.1960B.101.00	29710	Ø 19	60 cm	BEYAZ	8 590.00
4417.1960S.102.00	29706	Ø 19	60 cm	SİYAH	8 590.00
<b>RENKLİ NO2</b>					
4417.2160B.101.00	29711	Ø 21	60 cm	BEYAZ	8 660.00
4417.2160S.102.00	29707	Ø 21	60 cm	SİYAH	8 660.00
<b>RENKLİ NO3</b>					
4417.2560B.101.00	29712	Ø 25	60 cm	BEYAZ	6 823.40
4417.2560S.102.00	29708	Ø 25	60 cm	SİYAH	6 823.40
<b>RENKLİ NO4</b>					
4417.2860B.101.00	29713	Ø 28	60 cm	BEYAZ	4 1020.00
4417.2860S.102.00	29709	Ø 28	60 cm	SİYAH	4 1020.00



**YENİ!**

**LÜKS MİNİ İZGARALI KOLON KÜLLÜK**

Ürün Kodu	Kısa Kod	Yükseklik	Kalite		Fiyat
<b>SS 430</b>					
4418.1458S.430.00	29734	Ø 14	58 cm	S.S. 430	4 550.00
<b>BEYAZ</b>					
4418.1458B.101.00	29736	Ø 14	58 cm		4 533.40
<b>SİYAH</b>					
4418.1458S.102.00	29735	Ø 14	58 cm		4 533.40



**YENİ!**



### IZGARALI KOLON KÜLLÜK

Ürün Kodu	Kısa Kod	Çap	Yükseklik	Kalite	Fiyat
<b>SS 430</b>					
4513.2860I.430.0	13331	Ø 26	60 cm	S.S. 430	6 703.40



### ŞAMPANYA KÜLLÜK

Ürün Kodu	Kısa Kod	Yükseklik	Kalite	Fiyat
<b>SS 430</b>				
4418.3165S.430.00	13340	Ø 32	61 cm	S.S. 430 4 610.00
<b>RENKLİ BEYAZ</b>				
4418.3165B.101.00	28765	Ø 32	61 cm	4 646.70
<b>RENKLİ SİYAH</b>				
4418.3165S.102.00	28766	Ø 32	61 cm	4 646.70



### LÜKS ŞAMPANYA KÜLLÜK

Ürün Kodu	Kısa Kod	Yükseklik	Kalite	Fiyat
<b>SS 430</b>				
4420.3157S.430.00	29731	Ø 32	57 cm	S.S. 430 4 786.70
<b>RENKLİ BEYAZ</b>				
4420.3157B.101.00	29733	Ø 32	57 cm	4 833.40
<b>RENKLİ SİYAH</b>				
4420.3157S.102.00	29732	Ø 32	57 cm	4 833.40



### LOBİ KÜLLÜK

Ürün Kodu	Kısa Kod	Yükseklik	Kalite	Fiyat
<b>SS 430</b>				
4418.2671S.430.00	13339	Ø 26	67 cm	S.S. 430 4 616.70
<b>RENKLİ BEYAZ</b>				
4418.2671B.101.00	28760	Ø 26	67 cm	4 590.00
<b>RENKLİ SİYAH</b>				
4418.2671S.102.00	28761	Ø 26	67 cm	4 590.00

**YENİ!**



**U TİPİ**

Ürün Kodu	Kısa Kod	Ölçü	Fiyat
<b>DKP</b>			
4505.5047S.000.00	13345	45x72.5x42 cm	1 1570.00

• Boyalı



**BORU TİPİ**

Ürün Kodu	Kısa Kod	Ölçü	Fiyat
<b>DKP</b>			
4539.5049U.000.00	13346	45x117 cm	1 1356.70

• Boyalı



**ŞAPKALI**

Ürün Kodu	Kısa Kod	Ölçü	Fiyat
<b>DKP</b>			
4539.5048S.000.00	13347	45x117x45 cm	1 1603.40

• Boyalı



**BORU TİPİ DÜZ**

Ürün Kodu	Kısa Kod	Ölçü	Fiyat
<b>DKP</b>			
4505.5045S.000.00	13348	45x100 cm	1 1320.00

• Boyalı



**ŞAPKALI PASLANMAZ**

Ürün Kodu	Kısa Kod	Ölçü	Fiyat
<b>DKP + INOX</b>			
4539.5048S.430.00	27287	45x117x45 cm	1 1883.40

• Boyalı  
• Paslanmaz





### KARE AYAKLI BAHÇE TİPİ ÇÖP KOVASI

Ürün Kodu	Kısa Kod	Ölçü	Fiyat
<b>SS 430</b>			
4418.30101S.430.00	29714	S.S. 430 30x26x102 cm	2000.00
<b>RENKLİ</b>			
4418.30101Y.106.00	29715	YEŞİL 30x26x102 cm	1963.40
4418.30101B.101.00	29716	SİYAH 30x26x102 cm	1963.40
4418.30101S.102.00	29717	BEYAZ 30x26x102 cm	1963.40



### LÜKS IZGARALI DIŞ MEKAN ÇÖP KOVASI

Ürün Kodu	Kısa Kod	Ölçü	Fiyat
<b>SS 430</b>			
4511.3040S.430.00	29721	S.S. 430 45x72.5x42 cm	1950.00
<b>DKP</b>			
4511.3040B.101.00	29722	DKP 45x72.5x42 cm	1870.00



### PASLANMAZ BAHÇE

Ürün Kodu	Kısa Kod	Ölçü	Fiyat
<b>PASLANMAZ U TİPİ SS 304</b>			
4518.50745.000.00	13350	50x47x74 cm	5020.00
<b>PASLANMAZ ŞAPKALI SS 304</b>			
4518.5099S.000.00	13349	50x48x115 cm	5113.40



### ENDÜSTRİYEL ÇÖP KOVASI

Ürün Kodu	Kısa Kod	Ölçü	Fiyat
<b>50 LT</b>			
4515.4045S.430.50	19769	40x47 cm	2233.40
<b>70 LT</b>			
4515.4065S.430.70	19770	40x67 cm	2523.40

### ZARF KAPAK

Ürün Kodu	Kısa Kod	Ölçü	Kalite	Fiyat
<b>SS 430 3'LÜ</b>				
AT.101.3430.P	18251	111x35.5x92 cm	S.S. 430	6936.70
<b>SS 430 4'LÜ</b>				
AT.101.4430.P	23442	148x35.5x92 cm	S.S. 430	9256.70

• Paslanmaz gövde



### SALLANIR KAPAK

Ürün Kodu	Kısa Kod	Ölçü	Kalite	Fiyat
<b>SS 430 3'LÜ</b>				
AT.102.3430.P	18248	111x35.5x92 cm	S.S. 430	6910.00
<b>SS 430 4'LÜ</b>				
AT.102.4430.P	23439	148x35.5x92 cm	S.S. 430	9046.70

• Paslanmaz gövde



### BOMBE KAPAK

Ürün Kodu	Kısa Kod	Ölçü	Kalite	Fiyat
<b>SS 430 3'LÜ</b>				
AT.103.3430.P	13337	102x27x69.5 cm	S.S. 430	3363.40
<b>SS 430 4'LÜ</b>				
AT.103.4430.P	23435	130x27x69.5 cm	S.S. 430	4313.40

• Paslanmaz gövde





### ZARF KAPAK BOYALI

Ürün Kodu	Kısa Kod	Ölçü	Kalite	Fiyat
<b>DKP 3'LÜ</b>				
AT.101.3100.B	23433	111x35.5x92 cm	DKP	6.623.40
<b>DKP 4'LÜ</b>				
AT.101.4100.B	23443	148x35.5x92 cm	DKP	8.840.00

- Boyalı gövde

### SALLANIR KAPAK BOYALI

Ürün Kodu	Kısa Kod	Ölçü	Kalite	Fiyat
<b>DKP 3'LÜ</b>				
AT.102.3100.B	18249	111x35.5x91 cm	DKP	6753.40
<b>DKP 4'LÜ</b>				
AT.102.4100.B	23440	148x35.5x91 cm	DKP	8953.40

- Boyalı gövde

### BOMBE KAPAK BOYALI

Ürün Kodu	Kısa Kod	Ölçü	Kalite	Fiyat
<b>DKP 3'LÜ</b>				
AT.103.3100.B	13338	102x27x69.5 cm	DKP	3353.40
<b>DKP 4'LÜ</b>				
AT.103.4100.B	23434	130x27x69.5 cm	DKP	4276.70

- Boyalı gövde

**ÇEMBERLİ KAPAK**

Ürün Kodu	Kısa Kod	Ölçü	Kalite	Fiyat
<b>SS 430 3'LÜ</b>				
AT.104.3430.P	18253	113.5x31x69.5 cm	S.S. 430	3883.40
<b>SS 430 4'LÜ</b>				
AT.104.4430.P	23436	150.5x31x69.5 cm	S.S. 430	4983.40

• Paslanmaz gövde



**PRATİK KAPAK**

Ürün Kodu	Kısa Kod	Ölçü	Kalite	Fiyat
<b>SS 430 3'LÜ</b>				
AT.105.3430.P	18242	113.5x31x69.5 cm	S.S. 430	4203.40
<b>SS 430 4'LÜ</b>				
AT.105.4430.P	23437	150.5x31x69.5 cm	S.S. 430	5246.70

• Paslanmaz gövde



Çöpler atık değil  
geri kazanılmayı bekleyen hammaddelerdir.



# WC FIRÇALIKLAR

**MICRO**

Ürün Kodu	Kısa Kod	Çap	Ölçü	Kalite		Fiyat
KF01.430K.36	13382	Ø 8	H.37 cm	S.S. 430	20	93.40



• Paslanmaz gövde

**AKILLI KAPAK EKO**

Ürün Kodu	Kısa Kod	Çap	Ölçü	Kalite		Fiyat
KF64.430K.36	27281	Ø 8	H.37 cm	S.S. 430	20	116.70
KF65.430K.36	27285	Ø 9	H.37 cm	S.S. 430	20	123.40



• Paslanmaz gövde

**DÜZ KAPAK**

Ürün Kodu	Kısa Kod	Çap	Yükseklik	Kalite		Fiyat
KF05.430K.36	13384	Ø 8	H.37 cm	S.S. 430	20	110.00
KF06.304K.36	13383	Ø 8	H.37 cm	S.S. 304	20	133.40
KF07.304K.36	13385	Ø 9	H.37 cm	S.S. 304	20	143.40
KF08.430K.36	13386	Ø 9	H.37 cm	S.S. 430	20	116.70



• Paslanmaz gövde

**ASKILI**

KF15.430K.36	13400	Ø 8	H.37 cm	S.S. 430	20	130.00
KF16.304K.36	13399	Ø 8	H.37 cm	S.S. 304	20	153.40
KF17.304K.36	13401	Ø 9	H.37 cm	S.S. 304	20	163.40
KF18.430K.36	13402	Ø 9	H.37 cm	S.S. 430	20	140.00

**BOMBE KAPAK**

Ürün Kodu	Kısa Kod	Çap	Yükseklik	Kalite		Fiyat
KF25.430K.36	13388	Ø 8	H.38 cm	S.S. 430	20	113.40
KF26.304K.36	13387	Ø 8	H.38 cm	S.S. 304	20	140.00
KF27.304K.36	13389	Ø 9	H.38 cm	S.S. 304	20	150.00
KF28.430K.36	13390	Ø 9	H.38 cm	S.S. 430	20	123.40



• Paslanmaz gövde

**ASKILI**

KF35.430K.36	13405	Ø 8	H.38 cm	S.S. 430	20	136.70
KF36.304K.36	13404	Ø 8	H.38 cm	S.S. 304	20	160.00
KF37.304K.36	13406	Ø 9	H.38 cm	S.S. 304	20	173.40
KF38.430K.36	13407	Ø 9	H.38 cm	S.S. 430	20	143.40

**DÜZ KAPAK DELİKLİ**

Ürün Kodu	Kısa Kod	Çap	Yükseklik	Kalite		Fiyat
KF46.430K.36	13392	Ø 9	H.37 cm	S.S. 430	20	136.70
KF45.304K.36	13391	Ø 9	H.37 cm	S.S. 304	20	153.40

**ASKILI**

KF48.430K.36	13409	Ø 9	H.37 cm	S.S. 430	20	150.00
KF47.304K.36	13408	Ø 9	H.37 cm	S.S. 304	20	176.70





Ürünlerimiz  göre üretilmiştir.

### DELUXE

Ürün Kodu	Kısa Kod	Çap	Ölçü	Kalite		Fiyat
 KF69.304K.36	28807	Ø 8	H.39 cm	S.S. 304	20	316.70



### PİRAMİT LÜKS

Ürün Kodu	Kısa Kod	Çap	Yükseklik	Kalite		Fiyat
 KF55.304K.36	13393	Ø 8	H.39 cm	S.S. 304	20	156.70
<b>ASKILI</b>						
KF56.304K.36	13410	Ø 8	H.39 cm	S.S. 304	20	176.70



### BİYELİ

Ürün Kodu	Kısa Kod	Çap	Ölçü	Kalite		Fiyat
 KF61.304K.36	13395	Ø 9	H.39.5 cm	S.S. 304	20	233.40

### AKILLI KAPAK SİLİKON FIRÇA

Ürün Kodu	Kısa Kod	Çap	Ölçü	Kalite		Fiyat
<b>LUX</b>						
 KF62.304K.36	13396	Ø 8	H.39 cm	S.S. 304	12	336.70
<b>KARE</b>						
KF63.304K.36	13397		37x8x8 cm	S.S. 304	12	476.70

### AYAKLI WC FIRÇALIK SET

Ürün Kodu	Kısa Kod	Ölçü	Kalite		Fiyat
 KF68.304K.72	13398	H.80 cm	S.S. 430	8	656.70
<b>RENKLİ</b>					
KF68.101B.72	28802	H.80 cm	BEYAZ	8	646.70
KF68.102S.72	28803	H.80 cm	SİYAH	8	646.70



**AKILLI KAPAK SİLİKONLU BOYALI FIRÇA**

Ürün Kodu	Kısa Kod	Renk	Ölçü	Fiyat
KF63.101B.36	28797	Beyaz	H.37 cm	12 430.00
KF63.102S.36	28798	Siyah	H.37 cm	12 430.00



**BOYALI WC FIRÇALIK**

Ürün Kodu	Kısa Kod	Çap	Renk	Ölçü	Fiyat
KF90.101B.36	18236	Ø 8	Beyaz	H.37 cm	20 100.00
KF91.102S.36	18238	Ø 8	Siyah	H.37 cm	20 100.00
KF92.103P.36	18237	Ø 8	Pembe	H.37 cm	20 100.00
KF93.104K.36	18235	Ø 8	Kırmızı	H.37 cm	20 100.00
KF94.105M.36	27022	Ø 8	Mor	H.37 cm	20 100.00



**HİJYENİK FIRÇA**

Ürün Kodu	Kısa Kod	Renk	Fiyat
KF99.101.36	27143	Beyaz	20 130.00
KF98.102.36	27144	Siyah	20 130.00

\*Fırça Sapı Fiyata Dahil Değildir.



**HİJYENİK FIRÇA**

Ürün Kodu	Kısa Kod	Çap	Yükseklik	Kalite	Fiyat
<b>EKO SAPLI</b>					
KF97.101.36	26458	Beyaz Ø 8.5	36x8x8 cm	S.S. 304	20 203.40
KF96.102.36	26459	Siyah Ø 8.5	36x8x8 cm	S.S. 304	20 203.40
<b>LÜKS SAPLI</b>					
KF95.101.36	27376	Beyaz Ø 9	36x8x8 cm	S.S. 304	20 223.40
KF94.102.36	27377	Siyah Ø 9	36x8x8 cm	S.S. 304	20 223.40



# ***DUŞ SETLERİ***



2  
FONKSİYON

mono  
FONKSİYON

SÜRGÜ  
DUŞ  
SİSTEMİ

DİRSEKLİ  
DUŞ  
SİSTEMİ

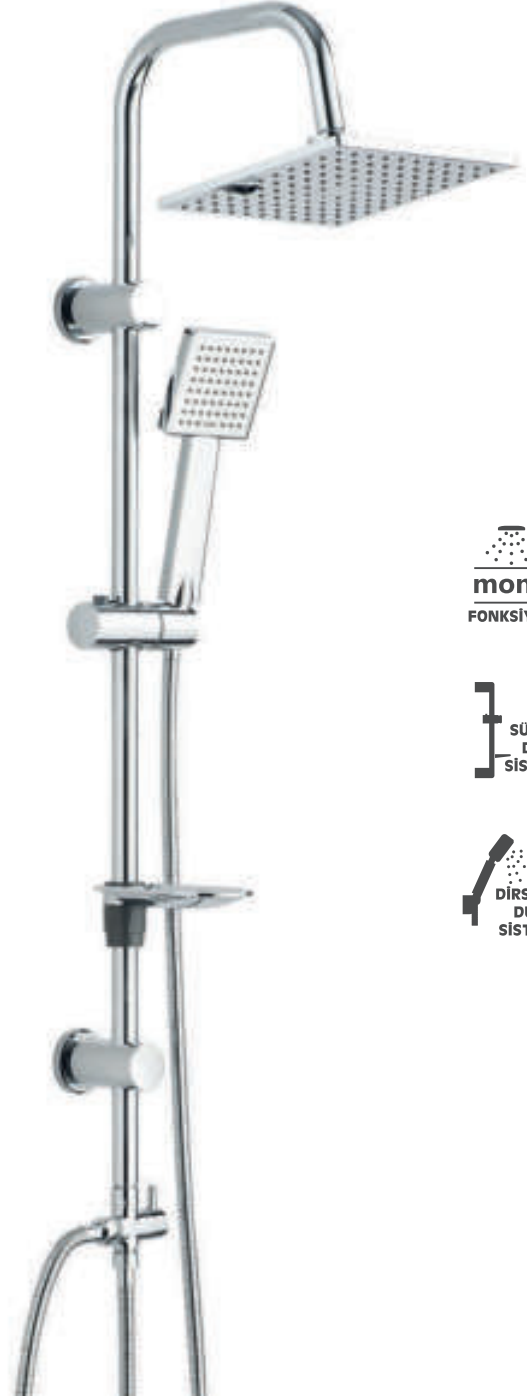

mono  
FONKSİYON

SÜRGÜ  
DUŞ  
SİSTEMİ

DİRSEKLİ  
DUŞ  
SİSTEMİ

## ROBOT LONDRA

Ürün Kodu	Kısa Kod	Fiyat
4910.01150.LR.11	27654	1773.40

## ROBOT BARCELONA

Ürün Kodu	Kısa Kod	Fiyat
4920.01150.BR.1	27655	1383.40

22 mm çapında paslanmaz çelik kromajlı "L" biçimli boru. Duş başlıkları orijinal ABS hammaddeden üretilmiştir. 250 mm tepe duşu ve 3 fonksiyonlu özel tasarım el duşu. Su tasarruf sistemi. Kireç kırıcı duş başlıkları. ½" - ½" 150-165cm. çift kenetli, paslanmaz çelik. EPDM hortumlu, kendinden contalı ve pirinç bağlantı uçlu spiral. Ergonomik kristal sabunluk. Plastikten üretilmiş özel montaj ayağı görevi de gören krom kaplama yönlendirici. Her armatüre uyan adaptör ve montaj elemanları. Düşük su basınçlarında mükemmel su akışı sağlar. %50'ye kadar su tasarrufu sağlar. Özel yönlendiricisi ile tepe duşu ve el duşu geçişleri çok kolaydır. sızdırma yapmaz. Montajı kolaydır.

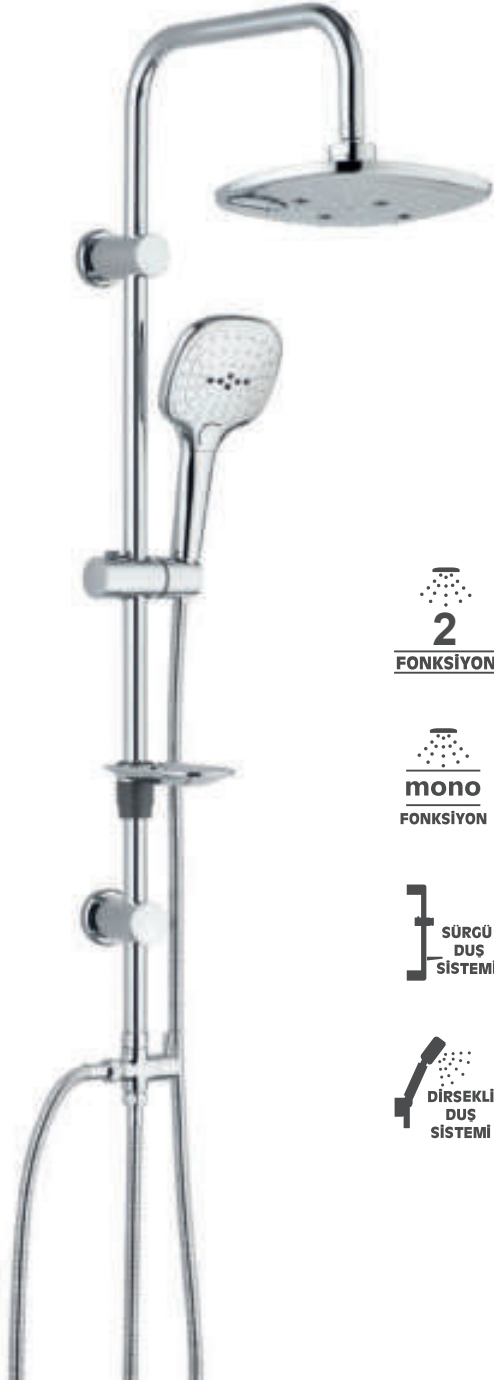

**2**  
FONKSİYON

**mono**  
FONKSİYON

**SÜRGÜ**  
DUŞ  
SİSTEMİ

**DİRSEKLİ**  
DUŞ  
SİSTEMİ



**5**  
FONKSİYON

**mono**  
FONKSİYON

**SÜRGÜ**  
DUŞ  
SİSTEMİ

**DİRSEKLİ**  
DUŞ  
SİSTEMİ

**ROBOT PARİS**

Ürün Kodu	Kısa Kod		Fiyat
4930.01150.PR.1	27656	8	1520.00

**ROBOT CUBA**

Ürün Kodu	Kısa Kod		Fiyat
4969.01160.CR.3	26487	8	1586.70

22 mm çapında paslanmaz çelik kromajlı "L" biçimli boru. Duş başlıkları orijinal ABS hammaddeden üretilmiştir. 250 mm tepe duşu ve 3 fonksiyonlu özel tasarım el duşu. Su tasarruf sistemi. Kireç kırıcı duş başlıkları. ½" – ½" 150-165cm. çift kenetli. paslanmaz çelik. EPDM hortumlu. kendinden contalı ve pirinç bağlantı uçlu spiral. Ergonomik kristal sabunluk. Plastikten üretilmiş özel montaj ayağı görevi de gören krom kaplama yönlendirici. Her armatüre uyan adaptör ve montaj elemanları. Düşük su basınçlarında mükemmel su akışı sağlar. %50'ye kadar su tasarrufu sağlar. Özel yönlendiricisi ile tepe duşu ve el duşu geçişleri çok kolaydır. sızdırma yapmaz. Montajı kolaydır.



**mono**  
FONKSİYON

**SÜRGÜ**  
DUŞ  
SİSTEMİ

**DİRSEKLI**  
DUŞ  
SİSTEMİ



**5**  
FONKSİYON

**mono**  
FONKSİYON

**SÜRGÜ**  
DUŞ  
SİSTEMİ

**DİRSEKLI**  
DUŞ  
SİSTEMİ

## ROBOT TOKYO

Ürün Kodu	Kısa Kod		Fiyat
4940.01150.TR.1	27657	8	1313.40

## ROBOT BERLİN

Ürün Kodu	Kısa Kod		Fiyat
4950.01150.BR.1	27658	8	1333.40

22 mm çapında paslanmaz çelik kromajlı "L" biçimli boru. Duş başlıkları orijinal ABS hammaddeden üretilmiştir. 250 mm tepe duşu ve 3 fonksiyonlu özel tasarım el duşu. Su tasarruf sistemi. Kireç kırıcı duş başlıkları. 1/2" - 1/2" 150-165cm. çift kenetli. paslanmaz çelik. EPDM hortumlu. kendinden contalı ve piring bağlantı uçlu spiral. Ergonomik kristal sabunluk. Plastikten üretilmiş özel montaj ayağı görevi de gören krom kaplama yönlendirici. Her armatüre uyan adaptör ve montaj elemanları. Düşük su basınçlarında mükemmel su akışı sağlar. %50'ye kadar su tasarrufu sağlar. Özel yönlendirici ile tepe duşu ve el duşu geçişleri çok kolaydır. sızdırmaz yapmaz. Montajı kolaydır.

  
**mono**  
FONKSİYON  
SÜRGÜ  
DUŞ  
SİSTEMİ  
DİRSEKLI  
DUŞ  
SİSTEMİ  
**5**  
FONKSİYON  
**mono**  
FONKSİYON  
SÜRGÜ  
DUŞ  
SİSTEMİ  
DİRSEKLI  
DUŞ  
SİSTEMİ**ROBOT RIO**

Ürün Kodu	Kısa Kod		Fiyat
4960.01150.RR.1	27659	8	1280.00

**ROBOT ROMA**

Ürün Kodu	Kısa Kod		Fiyat
4970.01150.RR.1	27660	8	1206.70

22 mm çapında paslanmaz çelik kromajlı "L" biçimli boru. Duş başlıkları orijinal ABS hammaddeden üretilmiştir. 250 mm tepe duşu ve 3 fonksiyonlu özel tasarım el duşu. Su tasarruf sistemi. Kireç kırıcı duş başlıkları. 1/2" - 1/2" 150-165cm. çift kenetli. paslanmaz çelik. EPDM hortumlu. kendinden contalı ve piriç bağlantı uçlu spiral. Ergonomik kristal sabunluk. Plastikten üretilmiş özel montaj ayağı görevi de gören krom kaplama yönlendirici. Her armatüre uyan adaptör ve montaj elemanları. Düşük su basınçlarında mükemmel su akışı sağlar. %50'ye kadar su tasarrufu sağlar. Özel yönlendirici ile tepe duşu ve el duşu geçişleri çok kolaydır. sızdırma yapmaz. Montajı kolaydır.



5  
FONKSİYON

mono  
FONKSİYON

SÜRGÜ  
DUŞ  
SİSTEMİ

DİRSEKLİ  
DUŞ  
SİSTEMİ



3  
FONKSİYON

mono  
FONKSİYON

SÜRGÜ  
DUŞ  
SİSTEMİ

DİRSEKLİ  
DUŞ  
SİSTEMİ

### ROBOT NAPOLİ

Ürün Kodu	Kısa Kod	Fiyat
4967.01150.NR.3	26493	1243.40

### ROBOT İSTANBUL

Ürün Kodu	Kısa Kod	Fiyat
4980.01150.IR.1	27661	1176.70

22 mm çapında paslanmaz çelik kromajlı "L" biçimli boru. Duş başlıkları orijinal ABS hammaddeden üretilmiştir. 250 mm tepe duşu ve 3 fonksiyonlu özel tasarım el duşu. Su tasarruf sistemi. Kireç kırıcı duş başlıkları. ½" - ½" 150-165cm. çift kenetli. paslanmaz çelik. EPDM hortumlu. kendinden contalı ve pirinç bağlantı uçlu spiral. Ergonomik kristal sabunluk. Plastikten üretilmiş özel montaj ayağı görevi de gören krom kaplama yönlendirici. Her armatüre uyan adaptör ve montaj elemanları. Düşük su basınçlarında mükemmel su akışı sağlar. %50'ye kadar su tasarrufu sağlar. Özel yönlendiricisi ile tepe duşu ve el duşu geçişleri çok kolaydır. sızdırma yapmaz. Montajı kolaydır.



**3**  
FONKSİYON

**mono**  
FONKSİYON

**SÜRGÜ**  
DUŞ  
SİSTEMİ

**DİRSEKLI**  
DUŞ  
SİSTEMİ



**3**  
FONKSİYON

**mono**  
FONKSİYON

**SÜRGÜ**  
DUŞ  
SİSTEMİ

**DİRSEKLI**  
DUŞ  
SİSTEMİ

**ROBOT VIYANA**

Ürün Kodu	Kısa Kod	Fiyat
4968.01150.VR.3	26490	8 1173.40

**ROBOT PUMA BLACK**

Ürün Kodu	Kısa Kod	Fiyat
4985.01150.PB.1	28830	8 1446.70

22 mm çapında paslanmaz çelik kromajlı "L" biçimli boru. Duş başlıkları orijinal ABS hammaddeden üretilmiştir. 250 mm tepe duşu ve 3 fonksiyonlu özel tasarım el duşu. Su tasarruf sistemi. Kireç kırıcı duş başlıkları. 1/2" - 1/2" 150-165cm. çift kenetli. paslanmaz çelik. EPDM hortumlu. kendinden contalı ve pirinç bağlantı uçlu spiral. Ergonomik kristal sabunluk. Plastikten üretilmiş özel montaj ayağı görevi de gören krom kaplama yönlendirici. Her armatüre uyan adaptör ve montaj elemanları. Düşük su basınçlarında mükemmel su akışı sağlar. %50'ye kadar su tasarrufu sağlar. Özel yönlendiricisi ile tepe duşu ve el duşu geçişleri çok kolaydır. sızdırma yapmaz. Montajı kolaydır.





5  
FONKSİYON

mono  
FONKSİYON

SÜRGÜ  
DUŞ  
SİSTEMİ

DİRSEKLİ  
DUŞ  
SİSTEMİ



3  
FONKSİYON

mono  
FONKSİYON

SÜRGÜ  
DUŞ  
SİSTEMİ

DİRSEKLİ  
DUŞ  
SİSTEMİ

### ROBOT LİZBON

Ürün Kodu	Kısa Kod	İkon	Fiyat
4925.01150.LR.1	31206	8	1133.40

### ROBOT LİZBON ZEBRA

Ürün Kodu	Kısa Kod	İkon	Fiyat
4926.01150.LK.1	31351	8	1250.00

22 mm çapında paslanmaz çelik kromajlı "L" biçimli boru. Duş başlıkları orijinal ABS hammaddeden üretilmiştir. 250 mm tepe duşu ve 3 fonksiyonlu özel tasarım el duşu. Su tasarruf sistemi. Kireç kırıcı duş başlıkları. ½" – ½" 150-165cm. çift kenetli. paslanmaz çelik. EPDM hortumlu. kendinden contalı ve pirinç bağlantı uçlu spiral. Ergonomik kristal sabunluk. Plastikten üretilmiş özel montaj ayağı görevi de gören krom kaplama yönlendirici. Her armatüre uyan adaptör ve montaj elemanları. Düşük su basınçlarında mükemmel su akışı sağlar. %50'ye kadar su tasarrufu sağlar. Özel yönlendiricisi ile tepe duşu ve el duşu geçişleri çok kolaydır. sızdıрма yapmaz. Montajı kolaydır.



**3**  
FONKSİYON

**mono**  
FONKSİYON

**SÜRGÜ**  
DUŞ  
SİSTEMİ

**DİRSEKLI**  
DUŞ  
SİSTEMİ



**3**  
FONKSİYON

**mono**  
FONKSİYON

**SÜRGÜ**  
DUŞ  
SİSTEMİ

**DİRSEKLI**  
DUŞ  
SİSTEMİ

**ROBOT SOFİA**

**ROBOT SOFİA ZEBRA**

Ürün Kodu	Kısa Kod	Fiyat
4915.01150.SR.1	31205	1133.40

Ürün Kodu	Kısa Kod	Fiyat
4916.01150.SK.1	31350	1250.00

22 mm çapında paslanmaz çelik kromajlı "L" biçimli boru. Duş başlıkları orijinal ABS hammaddeden üretilmiştir. 250 mm tepe duşu ve 3 fonksiyonlu özel tasarım el duşu. Su tasarruf sistemi. Kireç kırıcı duş başlıkları. 1/2" - 1/2" 150-165cm. çift kenetli. paslanmaz çelik. EPDM hortumlu. kendinden contalı ve pirinç bağlantı uçlu spiral. Ergonomik kristal sabunluk. Plastikten üretilmiş özel montaj ayağı görevi de gören krom kaplama yönlendirici. Her armatüre uyan adaptör ve montaj elemanları. Düşük su basınçlarında mükemmel su akışı sağlar. %50'ye kadar su tasarrufu sağlar. Özel yönlendiricisi ile tepe duşu ve el duşu geçişleri çok kolaydır. sızdırma yapmaz. Montajı kolaydır.



5  
FONKSİYON

mono  
FONKSİYON

SÜRGÜ  
DUŞ  
SİSTEMİ

DİRSEKLİ  
DUŞ  
SİSTEMİ

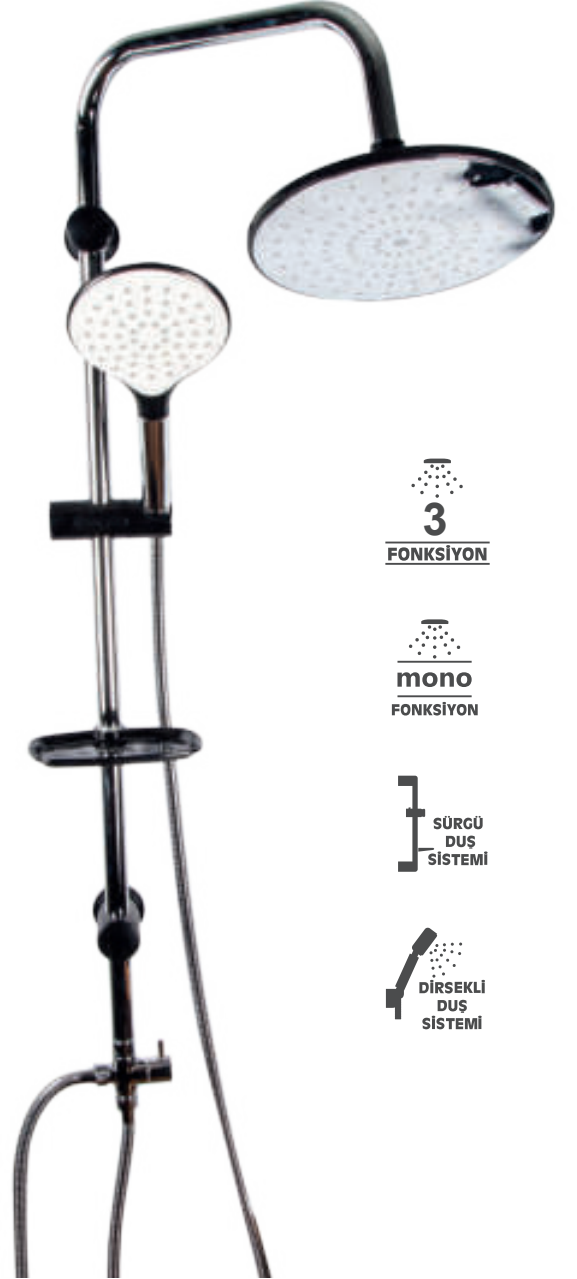

3  
FONKSİYON

mono  
FONKSİYON

SÜRGÜ  
DUŞ  
SİSTEMİ

DİRSEKLİ  
DUŞ  
SİSTEMİ

### ROBOT LİZBON BLACK

Ürün Kodu	Kısa Kod	İkon	Fiyat
4975.01150.LB.1	31354	8	1133.40

### ROBOT LİZBON BLACK ZEBRA

Ürün Kodu	Kısa Kod	İkon	Fiyat
4976.01150.LB.1	31353	8	1250.00

22 mm çapında paslanmaz çelik kromajlı "L" biçimli boru. Duş başlıkları orijinal ABS hammaddeden üretilmiştir. 250 mm tepe duşu ve 3 fonksiyonlu özel tasarım el duşu. Su tasarruf sistemi. Kireç kırıcı duş başlıkları. ½" - ½" 150-165cm. çift kenetli. paslanmaz çelik. EPDM hortumlu. kendinden contalı ve pirinç bağlantı uçlu spiral. Ergonomik kristal sabunluk. Plastikten üretilmiş özel montaj ayağı görevi de gören krom kaplama yönlendirici. Her armatüre uyan adaptör ve montaj elemanları. Düşük su basınçlarında mükemmel su akışı sağlar. %50'ye kadar su tasarrufu sağlar. Özel yönlendiricisi ile tepe duşu ve el duşu geçişleri çok kolaydır. sızdırma yapmaz. Montajı kolaydır.



**5**  
FONKSİYON

**mono**  
FONKSİYON

SÜRGÜ  
DUŞ  
SİSTEMİ

DİRSEKLI  
DUŞ  
SİSTEMİ

**ROBOT PANDA BLACK**

Ürün Kodu	Kısa Kod		Fiyat
4990.01150.PB.1	28831	8	1103.40



**mono**  
FONKSİYON

SÜRGÜ  
DUŞ  
SİSTEMİ

DİRSEKLI  
DUŞ  
SİSTEMİ

**SÜRGÜLÜ PANDA BLACK**

Ürün Kodu	Kısa Kod		Fiyat
4912.01150.PB.2	28832	20	360.00



**mono**  
FONKSİYON

DİRSEKLI  
DUŞ  
SİSTEMİ

**MAFSALLI PANDA BLACK**

Ürün Kodu	Kısa Kod		Fiyat
4953.01150.PB.2	28833	28	206.70

22 mm çapında paslanmaz çelik kromajlı "L" biçimli boru. Duş başlıkları orijinal ABS hammaddeden üretilmiştir. 250 mm tepe duşu ve 3 fonksiyonlu özel tasarım el duşu. Su tasarruf sistemi. Kireç kırıcı duş başlıkları. ½" - ½" 150-165cm. çift kenetli. paslanmaz çelik. EPDM hortumlu. kendinden contalı ve piring bağlantı uçlu spiral. Ergonomik kristal sabunluk. Plastikten üretilmiş özel montaj ayağı görevi de gören krom kaplama yönlendirici. Her armatüre uyan adaptör ve montaj elemanları. Düşük su basınçlarında mükemmel su akışı sağlar. %50'ye kadar su tasarrufu sağlar. Özel yönlendiricisi ile tepe duşu ve el duşu geçişleri çok kolaydır. sızdırma yapmaz. Montajı kolaydır.

# DUŞ SETLERİ

**MAXIFLOW**  
Maksimum akış...



2  
FONKSİYON

SÜRGÜ  
DUŞ  
SİSTEMİ

DİRSEKLİ  
DUŞ  
SİSTEMİ

## SÜRGÜLÜ LONDRA

Ürün Kodu	Kısa Kod		Fiyat
4911.01150.LS.2	27662	20	790.00



mono  
FONKSİYON

SÜRGÜ  
DUŞ  
SİSTEMİ

DİRSEKLİ  
DUŞ  
SİSTEMİ

## SÜRGÜLÜ BARCELONA

Ürün Kodu	Kısa Kod		Fiyat
4921.01150.BS.2	27663	20	680.00



2  
FONKSİYON

SÜRGÜ  
DUŞ  
SİSTEMİ

DİRSEKLİ  
DUŞ  
SİSTEMİ

## SÜRGÜLÜ PARIS

Ürün Kodu	Kısa Kod		Fiyat
4931.01150.PS.2	27664	20	520.00



3  
FONKSİYON

SÜRGÜ  
DUŞ  
SİSTEMİ

DİRSEKLİ  
DUŞ  
SİSTEMİ

## SÜRGÜLÜ CUBA

Ürün Kodu	Kısa Kod		Fiyat
4969.01160.CS.2	26486	20	446.70



mono  
FONKSİYON

SÜRGÜ  
DUŞ  
SİSTEMİ

DİRSEKLİ  
DUŞ  
SİSTEMİ

**SÜRGÜLÜ TOKYO**

Ürün Kodu	Kısa Kod	Fiyat
4941.01150.BS.2	27665	20 536.70



5  
FONKSİYON

SÜRGÜ  
DUŞ  
SİSTEMİ

DİRSEKLİ  
DUŞ  
SİSTEMİ

**SÜRGÜLÜ BERLİN**

Ürün Kodu	Kısa Kod	Fiyat
4951.01150.BS.2	27666	20 356.70



mono  
FONKSİYON

SÜRGÜ  
DUŞ  
SİSTEMİ

DİRSEKLİ  
DUŞ  
SİSTEMİ

**SÜRGÜLÜ RIO**

Ürün Kodu	Kısa Kod	Fiyat
4961.01150.RS.2	27667	20 320.00



5  
FONKSİYON

SÜRGÜ  
DUŞ  
SİSTEMİ

DİRSEKLİ  
DUŞ  
SİSTEMİ

**SÜRGÜLÜ ROMA**

Ürün Kodu	Kısa Kod	Fiyat
4971.01150.RS.2	27668	20 320.00



**3**  
FONKSİYON

SÜRGÜ  
DUŞ  
SİSTEMİ

DİRSEKLİ  
DUŞ  
SİSTEMİ

## SÜRGÜLÜ NAPOLI

Ürün Kodu	Kısa Kod		Fiyat
4967.01150.NS.2	26492	20	446.70



**mono**  
FONKSİYON

SÜRGÜ  
DUŞ  
SİSTEMİ

DİRSEKLİ  
DUŞ  
SİSTEMİ

## SÜRGÜLÜ SOFİA BLACK

Ürün Kodu	Kısa Kod		Fiyat
4918.01150.SB.2	31405	20	446.70



**mono**  
FONKSİYON

SÜRGÜ  
DUŞ  
SİSTEMİ

DİRSEKLİ  
DUŞ  
SİSTEMİ

## SÜRGÜLÜ SOFİA

Ürün Kodu	Kısa Kod		Fiyat
4916.01150.SS.2	31209	20	446.70



**mono**  
FONKSİYON

SÜRGÜ  
DUŞ  
SİSTEMİ

DİRSEKLİ  
DUŞ  
SİSTEMİ

## SÜRGÜLÜ LİZBON

Ürün Kodu	Kısa Kod		Fiyat
4917.01150.LS.2	31210	20	446.70



3  
FONKSİYON

SÜRGÜ  
DUŞ  
SİSTEMİ

DİRSEKLI  
DUŞ  
SİSTEMİ

**SÜRGÜLÜ İSTANBUL**

Ürün Kodu	Kısa Kod		Fiyat
4981.01150.IS.2	27669	20	293.40



mono  
FONKSİYON

SÜRGÜ  
DUŞ  
SİSTEMİ

DİRSEKLI  
DUŞ  
SİSTEMİ

**SÜRGÜLÜ VİYANA**

Ürün Kodu	Kısa Kod		Fiyat
4968.01150.VS.2	26489	20	380.00



mono  
FONKSİYON

DİRSEKLI  
DUŞ  
SİSTEMİ

**MAFSALLI NAPOLİ**

Ürün Kodu	Kısa Kod		Fiyat
4967.01150.NM.1	26491	28	233.40



mono  
FONKSİYON

DİRSEKLI  
DUŞ  
SİSTEMİ

**MAFSALLI VİYANA**

Ürün Kodu	Kısa Kod		Fiyat
4968.01150.VM.1	26488	28	186.70





5  
FONKSİYON



## MAFSALLI BERLİN

Ürün Kodu	Kısa Kod		Fiyat
4952.01150.BM.3	27670	28	273.40



3  
FONKSİYON



## MAFSALLI İSTANBUL

Ürün Kodu	Kısa Kod		Fiyat
4982.01150.IM.3	27671	28	156.70



mono  
FONKSİYON



## MAFSALLI BAKÜ

Ürün Kodu	Kısa Kod		Fiyat
4993.01150.BM.3	27672	28	140.00





**PANEL DUŞ ARAS**

Ürün Kodu	Kısa Kod		Fiyat
4965.01150AP3	26324	1	6113.40



**PANEL DUŞ CEYHAN**

Ürün Kodu	Kısa Kod		Fiyat
4965.01150CP2	26320	1	5790.00



**PANEL DUŞ MERİÇ**

Ürün Kodu	Kısa Kod		Fiyat
4965.01150MP1	26319	1	6826.70



Parlak

## DİŞ FIRÇALIK

Ürün Kodu	Kısa Kod	Ölçü	Fiyat
SS 304			
4711.22.711.0	13530	Ø 7x11 cm	20 126.70



Duvara  
Montaj

Plastik  
Pompa

Mat

Parlak

## KÖPÜKLÜ

Ürün Kodu	Kısa Kod	Ölçü	Fiyat
SS 304			
4711.09.100.M	13411 Mat	1000 ml 22x6x13 cm	20 403.40
4711.09.100.P	13412 Parlak	1000 ml 22x6x13 cm	20 410.00



## SET ÜSTÜ / ASKILIKLI

Ürün Kodu	Kısa Kod	Ölçü	Fiyat
SS 304			
4711.17.718.0	13413	Ø 7x17 cm	20 150.00
4711.16.717.0	13414 Askılı	Ø 7x17 cm	20 173.40



## KÜRE SET ÜSTÜ

Ürün Kodu	Kısa Kod	Ölçü	Fiyat
SS 304			
4711.19.916.0	13416	Ø 9x14.5 cm	20 173.40



## ANKASTRE

Ürün Kodu	Kısa Kod	Çap	Ölçü	Fiyat
SIVI SABUNLUK				
4716.0921S.304.00	13426	Ø 9	21 cm	20 220.00
KÖPÜKLÜ				
4716.0921S.304.01	13427	Ø 9	21 cm	12 540.00



## DEZENFEKTAN APARATI

Ürün Kodu	Kısa Kod	Ölçü	Fiyat
ABS			
HD.99.0000.PL	28894	21 cm	40 86.70
SS 304			
HD.99.0304.KR	13427	21 cm	20 446.70



**SABUNLUK**

Ürün Kodu	Kısa Kod	Ölçü	Fiyat
SS 304 500 ml 4711.02.050.P	13417	16x6x10 cm	293.40
SS 304 1000 ml 4711.06.100.P	13419	22x6x13 cm	386.70



**SABUNLUK**

Ürün Kodu	Kısa Kod	Ölçü	Fiyat
SS 304 500 ml 4711.01.050.M	13420	16x6x10 cm	290.00
SS 304 1000 ml 4711.05.100.M	13421	22x6x13 cm	380.00



**SABUNLUK**

Ürün Kodu	Kısa Kod	Ölçü	Fiyat
SS 304 500 ml 4711.04.050.P	13422	16x6x10 cm	333.40
SS 304 1000 ml 4711.08.100.P	13423	22x6x13 cm	426.70



**SABUNLUK**

Ürün Kodu	Kısa Kod	Ölçü	Fiyat
SS 304 500 ml 4711.03.050.M	13424	16x6x10 cm	320.00
SS 304 1000 ml 4711.07.100.M	13425	22x6x13 cm	413.40

## ÇÖP KOVALI KAĞITLIK

Ürün Kodu	Kısa Kod	Ölçü	Kalite	Fiyat
<b>OVAL 200 'LÜK</b>				
4546.2010S.102.00	29847	105x27.5x12 cm	Siyah	1263.40
4546.2010B.101.00	29846	105x27.5x12 cm	Beyaz	1263.40
4546.2010S.430.00	29845	105x27.5x12 cm	SS 430	1336.70
4546.2010S.304.00	31392	105x27.5x12 cm	SS 304	2053.40
<b>OVAL 400 'LÜK</b>				
4546.2610S.102.00	29851	105x27.5x12 cm	Siyah	1366.70
4546.2610B.101.00	29850	105x27.5x12 cm	Beyaz	1366.70
4546.2610S.430.00	13352	105x27.5x12 cm	SS 430	1460.00
4546.2610S.304.00	13394	105x27.5x12 cm	SS 304	2253.40
<b>DÜZ 200 'LÜK</b>				
4549.2010S.102.00	29844	105x27.5x12 cm	Siyah	1273.40
4549.2010B.101.00	29843	105x27.5x12 cm	Beyaz	1273.40
4549.2010S.430.00	29842	105x27.5x12 cm	SS 430	1353.40
4549.2010S.304.00	31391	105x27.5x12 cm	SS 304	2076.70
<b>DÜZ 400 'LÜK</b>				
4549.2610S.102.00	29849	105x27.5x12 cm	Siyah	1376.70
4549.2610B.101.00	29848	105x27.5x12 cm	Beyaz	1376.70
4549.2610S.430.00	13354	105x27.5x12 cm	SS 430	1476.70
4549.2610S.304.00	13393	105x27.5x12 cm	SS 304	2276.70



## Z KATLAMA KAĞIT HAVLULUK

Ürün Kodu	Kısa Kod	Ölçü	Kalite	Fiyat
<b>200 'LÜK</b>				
4922.2026S.102.00	28896	20.5x27x10 cm	Siyah	330.00
4922.2026B.101.00	28895	20.5x27x10 cm	Beyaz	330.00
4922.2026P430.00	13365	20.5x27x10 cm	SS 430	376.70
4922.2026P304.00	13364	20.5x27x10 cm	SS 304	536.70
<b>400 'LÜK</b>				
4922.3226S.102.00	28898	27x35x10 cm	Siyah	426.70
4922.3226B.101.00	28897	27x35x10 cm	Beyaz	426.70
4922.3226P430.00	13367	27x35x10 cm	SS 430	510.00
4922.3226P304.00	13366	27x35x10 cm	SS 304	733.40





**JUMBO WC KAĞIT VERİCİ**

Ürün Kodu	Kısa Kod	Ölçü	Kalite		Fiyat
<b>Ø 22</b>					
4923.2212S.102.00	28900	12 cm	Siyah	1	340.00
4923.2212B.101.00	28899	12 cm	Beyaz	1	340.00
4923.2212S.430.00	13370	12 cm	SS 430	1	380.00
4923.2212S.304.00	13369	12 cm	SS 304	1	533.40
<b>Ø 27</b>					
4923.2712S.102.00	28902	12 cm	Siyah	1	370.00
4923.2712B.101.00	28901	12 cm	Beyaz	1	370.00
4923.2712S.430.00	13372	12 cm	SS 430	1	416.70
4923.2712S.304.00	13371	12 cm	SS 304	1	590.00



**GÜLEN AĞIZ KAĞIT VERİCİ**

Ürün Kodu	Kısa Kod	Ölçü	Kalite		Fiyat
4923.2739S.102.00	28906	28x5.5x39 cm	Siyah	1	296.70
4923.2739B.101.00	28905	28x5.5x39 cm	Beyaz	1	296.70
4923.2739S.430.00	13374	28x5.5x39 cm	SS 430	1	320.00
4923.2739S.304.00	13373	28x5.5x39 cm	SS 304	1	460.00



**CİMRİ KAĞIT VERİCİ**

Ürün Kodu	Kısa Kod	Ölçü	Kalite		Fiyat
4923.2013S.102.00	28904	Ø 21x13.5 cm	Siyah	12	490.00
4923.2013B.101.00	28903	Ø 21x13.5 cm	Beyaz	12	490.00
4923.2013S.304.00	13368	Ø 21x13.5 cm	SS 304	12	693.40





## LAMALI RAF HAVLULUK

Ürün Kodu	Kısa Kod	Çap	Ölçü	Fiyat
SS 304 4949.3051S.304.00	13526	Ø 19	50x29x12.5 cm	12 623.40



## RAF HAVLULUK

Ürün Kodu	Kısa Kod	Çap	Ölçü	Fiyat
SS 304 4949.3162S.304.00	13527	Ø 19	50x20x13 cm	25 496.70



## AÇILI DESTEKLİ RAF HAVLULUK

Ürün Kodu	Kısa Kod	Çap	Ölçü	Fiyat
SS 304 4950.5019S.304.00	13528	Ø 19	50x28x19 cm	12 583.40



## DESTEKLİ RAF HAVLULUK

Ürün Kodu	Kısa Kod	Çap	Ölçü	Fiyat
SS 304 4950.3162S.304.00	13529	Ø 19	50x29x12 cm	12 576.70



## ÇİFT KAT RAF HAVLULUK

Ürün Kodu	Kısa Kod	Ölçü	Fiyat
SS 304 4947.3051S.304.00	28893	50x27x13 cm	1 756.70



## PASLANMAZ ETAJER

Ürün Kodu	Kısa Kod	Ölçü	Fiyat
SS 304 AK.161.4709.P	27288	47x9x4 cm	1 263.40
SS 304 KORUMALI AK.162.4710.P	27289	47x9x4 cm	1 450.00

**LOFT KAPI KOLU Ø25**

Ürün Kodu	Kısa Kod	Ölçü	Kalite	Fiyat
4823.2530P.304.00	28824	8.5x30 cm	S.S. 304	203.40
4823.2540P.304.00	28825	8.5x40 cm	S.S. 304	230.00
4823.2550P.304.00	28826	8.5x50 cm	S.S. 304	253.40

**LOFT KAPI KOLU Ø 32**

Ürün Kodu	Kısa Kod	Ölçü	Kalite	Fiyat
4823.3230P.304.00	28827	8x30 cm	S.S. 304	213.40
4823.3240P.304.00	28828	8x40 cm	S.S. 304	246.70
4823.3250P.304.00	28829	8x50 cm	S.S. 304	296.70

**ROYAL KAPI KOLU Ø 25**

Ürün Kodu	Kısa Kod	Ölçü	Kalite	Fiyat
<b>ROZETLİ</b>				
4822.2540P.304.00	28814	8.5x40 cm	S.S. 304	266.70
4822.2550P.304.00	28815	8.5x50 cm	S.S. 304	293.40
4822.2560P.304.00	28816	8.5x60 cm	S.S. 304	316.70

**ROYAL KAPI KOLU Ø 32**

Ürün Kodu	Kısa Kod	Ölçü	Kalite	Fiyat
<b>ROZETLİ</b>				
4822.3240P.304.00	28819	8x40 cm	S.S. 304	373.40
4822.3250P.304.00	28820	8x50 cm	S.S. 304	400.00
4822.3260P.304.00	28821	8x60 cm	S.S. 304	433.40







## ETAJER

Ürün Kodu	Kısa Kod		Fiyat
AK.173.3801.G	28834	10	733.40



## DİŞ FIRÇALIK

Ürün Kodu	Kısa Kod		Fiyat
AK.175.3804.G	28836	12	436.70



## UZUN HAVLULUK

Ürün Kodu	Kısa Kod		Fiyat
AK.177.3814.G	28837	15	900.00



## WC KAĞITLIK

Ürün Kodu	Kısa Kod		Fiyat
AK.179.3807.G	28840	20	573.40



## SABUNLUK

Ürün Kodu	Kısa Kod		Fiyat
AK.174.3803.G	28835	12	436.70



## BORNOZ ASKILIĞI

Ürün Kodu	Kısa Kod		Fiyat
AK.178.3827.G	28841	20	383.40

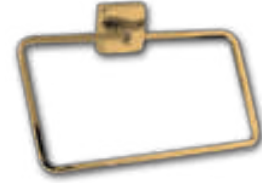

## YUVARLAK HAVLULUK

Ürün Kodu	Kısa Kod		Fiyat
AK.176.3817.G	28838	10	703.40



## WC KAPAKLI KAĞITLIK

Ürün Kodu	Kısa Kod		Fiyat
AK.180.3808.G	28839	20	690.00



**ETAJER**

Ürün Kodu	Kısa Kod		Fiyat
AK.01.3901.P	13437	25	470.00



**DIŞ FIRÇALIK**

Ürün Kodu	Kısa Kod		Fiyat
AK.01.3904.P	13439	25	333.40



**UZUN HAVLULUK**

Ürün Kodu	Kısa Kod		Fiyat
AK.06.3914.P	13442	24	453.40



**WC KAĞITLIK**

Ürün Kodu	Kısa Kod		Fiyat
AK.04.3907.P	13444	48	270.00



**SABUNLUK**

Ürün Kodu	Kısa Kod		Fiyat
AK.01.3903.P	13438	25	333.40



**BORNOZ ASKILIĞI**

Ürün Kodu	Kısa Kod		Fiyat
AK.08.3927.P	13443	50	180.00



**YUVARLAK HAVLULUK**

Ürün Kodu	Kısa Kod		Fiyat
AK.01.3917.P	13440	26	306.70



**WC KAPAKLI KAĞITLIK**

Ürün Kodu	Kısa Kod		Fiyat
AK.05.3908.P	13445	36	370.00

- Krom kaplama
- Zamak gövde

- SS 304 kalite paslanmaz kapak ve boru
- Kutu ambalaj



## ETAJER

Ürün Kodu	Kısa Kod	İkon	Fiyat
AK.222.3901.B	30874	25	470.00



## DİŞ FIRÇALIK

Ürün Kodu	Kısa Kod	İkon	Fiyat
AK.221.3904.B	30873	25	333.40



## UZUN HAVLULUK

Ürün Kodu	Kısa Kod	İkon	Fiyat
AK.224.3914.B	30876	24	453.40



## WC KAĞITLIK

Ürün Kodu	Kısa Kod	İkon	Fiyat
AK.225.3907.B	30877	48	270.00



## SABUNLUK

Ürün Kodu	Kısa Kod	İkon	Fiyat
AK.223.3903.B	30875	25	333.40



## BORNOZ ASKILIĞI

Ürün Kodu	Kısa Kod	İkon	Fiyat
AK.220.3927.B	30872	50	180.00



## YUVARLAK HAVLULUK

Ürün Kodu	Kısa Kod	İkon	Fiyat
AK.227.3917.B	30879	26	306.70



## WC KAPAKLI KAĞITLIK

Ürün Kodu	Kısa Kod	İkon	Fiyat
AK.226.3908.B	30878	36	370.00



**TEKLİ KAĞITLIK**

Ürün Kodu	Kısa Kod	Fiyat
AK.232.3917.D	30884	48 186.70

**BORNOZ ASKILIĞI**

Ürün Kodu	Kısa Kod	Fiyat
AK.236.3327.D	30888	50 176.70

**G HAVLULUK**

Ürün Kodu	Kısa Kod	Fiyat
AK.231.3317.D	30883	26 243.40

**WC KAĞITLIK**

Ürün Kodu	Kısa Kod	Fiyat
AK.230.3307.D	30882	48 203.40

**TEKLİ BORNOZ ASKILIĞI**

Ürün Kodu	Kısa Kod	Fiyat
AK.233.3326.D	30885	50 153.40

**UZUN HAVLULUK**

Ürün Kodu	Kısa Kod	Fiyat
AK.234.3314.D	30886	24 323.40

**KAĞIT HAVLULUK**

Ürün Kodu	Kısa Kod	Fiyat
AK.235.3612.D	30887	28 246.70



## ETAJER

Ürün Kodu	Kısa Kod		Fiyat
AK.74.3801.P	26134	5	580.00



## DİŞ FIRÇALIK

Ürün Kodu	Kısa Kod		Fiyat
AK.76.3804.P	26136	14	336.70



## UZUN HAVLULUK

Ürün Kodu	Kısa Kod		Fiyat
AK.80.3814.P	26140	10	686.70



## WC KAĞITLIK

Ürün Kodu	Kısa Kod		Fiyat
AK.77.3807.P	26137	24	353.40



## SABUNLUK

Ürün Kodu	Kısa Kod		Fiyat
AK.75.3803.P	26135	16	336.70



## BORNOZ ASKILIĞI

Ürün Kodu	Kısa Kod		Fiyat
AK.95.3827.P	28971 İKİLİ U	20	290.00



## YUVARLAK HAVLULUK

Ürün Kodu	Kısa Kod		Fiyat
AK.79.3817.P	26139	8	493.40



## WC KAPAKLI KAĞITLIK

Ürün Kodu	Kısa Kod		Fiyat
AK.78.3808.P	26138	8	430.00

- Krom kaplama
- Prinç gövde

- SS 304 kalite paslanmaz kapak . Rozet ve çubuk
- Kutu ambalaj



**ETAJER**

Ürün Kodu	Kısa Kod		Fiyat
AK.74.3801.P	13474	20	150.00



**DİŞ FIRÇALIK**

Ürün Kodu	Kısa Kod		Fiyat
AK.33.3604.P	13479	20	126.70



**UZUN HAVLULUK**

Ürün Kodu	Kısa Kod	Uzunluk		Fiyat
AK.40.3614.P	13475	40 cm	20	153.40



**WC KAĞITLIK**

Ürün Kodu	Kısa Kod		Fiyat
AK.34.3607.P	13480	20	113.40
AK.35.3608.P	13482	Kapaklı 20	140.00

- Krom kaplama
- Prinç gövde



**SABUNLUK**

Ürün Kodu	Kısa Kod		Fiyat
AK.32.3603.P	13477	20	126.70



**BORNOZ ASKILIĞI**

Ürün Kodu	Kısa Kod		Fiyat
AK.44.3621.P	13486	20	90.00



**YUVARLAK HAVLULUK**

Ürün Kodu	Kısa Kod		Fiyat
AK.42.3617.P	13481	20	113.40



**KAĞIT HAVLULUK**

Ürün Kodu	Kısa Kod		Fiyat
AK.38.3612.P	13483	20	140.00
AK.39.3613.P	13485	Kapaklı 15	166.70

- SS 304 kalite paslanmaz kapak . Rozet ve çubuk
- Vakumlu



## ETAJER

Ürün Kodu	Kısa Kod		Fiyat
AK.61.3501.P	26124	12	123.40



## DİŞ FIRÇALIK

Ürün Kodu	Kısa Kod		Fiyat
AK.62.3504.P	26125	20	63.40



## UZUN HAVLULUK

Ürün Kodu	Kısa Kod		Fiyat
AK.65.3514.P	26128	15	96.70



## WC KAĞITLIK

Ürün Kodu	Kısa Kod		Fiyat
AK.67.3507.P	26130	20	63.40



## SABUNLUK

Ürün Kodu	Kısa Kod		Fiyat
AK.63.3503.P	26126	16	63.40



## BORNOZ ASKILIĞI

Ürün Kodu	Kısa Kod		Fiyat
AK.66.3527.P	26129	24	63.40



## YUVARLAK HAVLULUK

Ürün Kodu	Kısa Kod		Fiyat
AK.64.3517.P	26127	15	76.70



## WC KAPAKLI KAĞITLIK

Ürün Kodu	Kısa Kod		Fiyat
AK.68.3508.P	26131	20	90.00

- Krom kaplama
- Alüminyum gövde

- SS 430 kalite paslanmaz Rozet ve kapak
- Demir çubuk
- Blister Ambalaj



### KARE LEDLİ MAKYAJ AYNASI

Ürün Kodu	Kısa Kod		Fiyat	
AK.98.3004.A	31195	SS 304	1	2523.40
AK.98.3008.S	31199	Siyah	1	2996.70



### LEDLİ MAKYAJ AYNASI

Ürün Kodu	Kısa Kod		Fiyat	
AK.97.3002.A	13506	SS 304	1	2003.40
AK.97.3006.S	31197	Siyah	1	2510.00



### ÇİFT TARAFLI MAKYAJ AYNASI ROZETLİ

Ürün Kodu	Kısa Kod		Fiyat	
AK.99.3003.A	31194	SS 304	1	1163.40
AK.99.3007.S	31198	Siyah	1	1536.70



### ÇİFT TARAFLI MAKYAJ AYNASI

Ürün Kodu	Kısa Kod		Fiyat	
AK.96.3001.A	13505	SS 304	1	1173.40
AK.96.3005.S	31196	Siyah	1	1546.70



# AKSESUARLAR



## OVAL AYNA

Ürün Kodu	Kısa Kod		Fiyat
AK.94.4002.A	13499 54x74 cm	5	1200.00



## LAVİ AYNA

Ürün Kodu	Kısa Kod		Fiyat
AK.90.4202.A	13501 40x50 cm	5	396.70



## DİKDÖRTGEN AYNA

Ürün Kodu	Kısa Kod		Fiyat
AK.95.4102.A	13500 55x75 cm	5	1306.70



## MİRA AYNA

Ürün Kodu	Kısa Kod		Fiyat
AK.91.4301.A	13502 40x50 cm	5	370.00
AK.92.4302.A	13503 40x60 cm	5	426.70
AK.93.4303.A	13504 50x70 cm	5	590.00

# MAXIFLOW

Maksimum akış...



## ASKILIK 2'Lİ 3'LÜ

Ürün Kodu	Kısa Kod		Fiyat
AK.70.4521.P	28866 2'li	24	70.00
AK.71.4529.P	28867 3'lü	24	86.70



## ROZETLİ ASKILIK

Ürün Kodu	Kısa Kod		Fiyat
AK.47.4529.P	28109 3'lü	24	143.40
AK.57.4529.P	28110 4'lü	24	160.00
AK.58.4529.P	28111 5'li	24	166.70



## 3'LÜ AKSESUAR SET

Ürün Kodu	Kısa Kod		Fiyat
AK.330.4500.P	28873	18	223.40



## 3'LÜ BLACK SET

Ürün Kodu	Kısa Kod		Fiyat
AK.440.4500.B	28875	18	246.70



**TEKLİ KÖŞE SÜNGERLİK**

Ürün Kodu	Kısa Kod		Fiyat
AK.61.6018.K	13509	18x18 cm 10	323.40

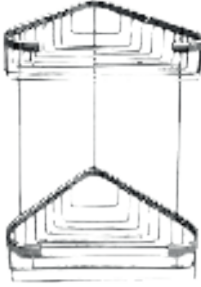

**İKİLİ KÖŞE SÜNGERLİK**

Ürün Kodu	Kısa Kod		Fiyat
AK.61.6118.K	13512	18x18 cm 10	666.70



**ÜÇLÜ KÖŞE SÜNGERLİK**

Ürün Kodu	Kısa Kod		Fiyat
AK.73.6218.K	13516	18x18 cm 12	960.00



**TEKLİ OVAL SÜNGERLİK**

Ürün Kodu	Kısa Kod		Fiyat
AK.62.6519.K	13510	19x19 cm 10	490.00
<b>GOLD</b>			
AK.210.6318.G	28890	19x19 cm 10	653.40
<b>SİYAH</b>			
AK.62.6519.S	31356	19x19 cm 10	640.00

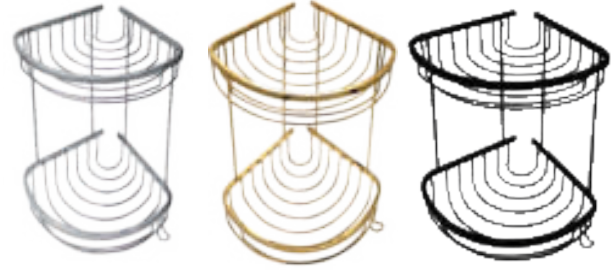

**İKİLİ OVAL SÜNGERLİK**

Ürün Kodu	Kısa Kod		Fiyat
AK.69.6619.K	13513	19x19 cm 10	1003.40
<b>GOLD</b>			
AK.211.6418.G	28891	19x19 cm 8	1333.40
<b>SİYAH</b>			
AK.69.6619.S	31357	19x19 cm 8	1316.70

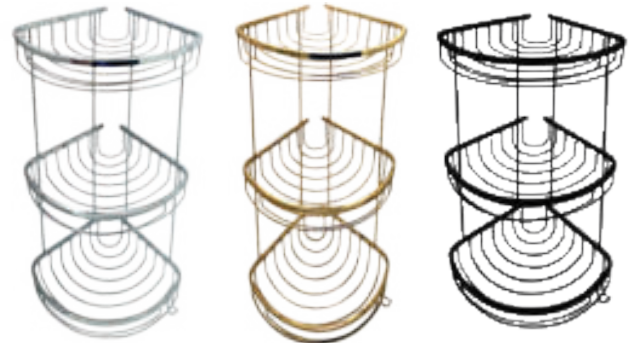

**ÜÇLÜ OVAL SÜNGERLİK**

Ürün Kodu	Kısa Kod		Fiyat
AK.254.6719.K	13515	19x19 cm 12	1460.00
<b>GOLD</b>			
AK.212.6518.G	28892	19x19 cm 4	2023.40
<b>SİYAH</b>			
AK.254.6719.S	31358	19x19 cm 4	1993.40

## OTOMATİK PLASTİK

Ürün Kodu	Kısa Kod	Yüzey	Ölçü	İkon	Fiyat
HD.01.4923.SM	13376	Şeffaf Mavi	27x22x36 cm	4	1920.00



## OTOMATİK PLASTİK BEYAZ

Ürün Kodu	Kısa Kod	Yüzey	Ölçü	İkon	Fiyat
HD.01.4923.SB	26359	Beyaz	27x22x36 cm	4	2043.40



## OTOMATİK PLASTİK KROM

Ürün Kodu	Kısa Kod	Yüzey	Ölçü	İkon	Fiyat
HD.01.4923.SK	13375	Krom	57x33x50 cm	4	2843.40



## Z KATLI DİSPANSER 200'LÜK

Ürün Kodu	Kısa Kod	Yüzey	Ölçü	İkon	Fiyat
HD.03.4923.SM	13378	Şeffaf Mavi	23x21x9 cm	12	140.00



## Z KATLI DİSPANSER 300'LÜK

Ürün Kodu	Kısa Kod	Yüzey	Ölçü	İkon	Fiyat
HD.02.4923.SM	30960	Şeffaf Mavi	26x29x11 cm	20	193.40
HD.02.4923.SY	30958	Siyah	26x29x11 cm	20	293.40





• Şeffaf manuel

**JUMBO TUVALET KAĞIDI VERİCİ**

Ürün Kodu	Kısa Kod	Yüzey	Ölçü		Fiyat
HD.06.4923.SM	30972	Şeffaf Mavi	Ø24x26 cm	20	186.70
HD.06.4923.SY	30970	Siyah	Ø24x26 cm	20	293.40



**CİMRİ KAĞIT VERİCİ**

Ürün Kodu	Kısa Kod	Yüzey	Ölçü		Fiyat
HD.08.4923.SM	30981	Şeffaf Mavi	Ø20 cm	20	183.40
HD.07.4923.SM	30978	Şeffaf Mavi	Ø25 cm	12	270.00
HD.07.4923.SF	30979	Şeffaf Füme	Ø25 cm	12	270.00
HD.07.4923.SY	30976	Siyah	Ø25 cm	12	363.40



**MINİ JUMBO KAĞIT VERİCİ**

Ürün Kodu	Kısa Kod	Yüzey	Ölçü		Fiyat
HD.04.4923.SM	30966	Şeffaf Mavi	Ø21x24 cm	12	153.40



**PLASTİK GÜLEN AĞIZ**

Ürün Kodu	Kısa Kod	Yüzey	Ölçü		Fiyat
HD.11.4924.SY	30988	Siyah	29x41 cm	20	293.40



**PLASTİK KÖPÜK VERİCİ**

Ürün Kodu	Kısa Kod	Yüzey	Ölçü		Fiyat
HD.44.4715.SY	30954	Siyah	11x21x12 cm	15	296.70



**SIVI SABUNLUK**

Ürün Kodu	Kısa Kod	Yüzey	Kapasite		Fiyat
HD.35.4716.SM	13434	Şeffaf Mavi	500 ml	50	80.00
HD.37.4716.SM	13435	Şeffaf Mavi	1000 ml	50	116.70

## BORU KAPAMA ROZETİ TEKLİ

Ürün Kodu	Kısa Kod	Yüzey	Ölçü	Fiyat
2768.016.00.B	13536	Beyaz	Ø 2 -Ø7-10 cm	500 23.40
2768.016.00.K	13537	Krom	Ø 2 -Ø7-10 cm	500 50.00



## HAREKETLİ BORU KAPAMA TEKLİ KİLİTLİ

Ürün Kodu	Kısa Kod	Yüzey	Ölçü	Fiyat
2769.022.00.B	31186	Beyaz	Ø 2.5 -Ø6.5-15 cm	250 30.00
2769.022.00.K	31187	Krom	Ø 2.5 -Ø6.5-15 cm	250 70.00



## BORU KAPAMA ROZETİ ÇİFTLİ

Ürün Kodu	Kısa Kod	Yüzey	Ölçü	Fiyat
2768.017.00.B	13538	Beyaz	8.5x13x14 cm	100 30.00
2768.017.00.K	13539	Krom	8.5x13x14 cm	100 100.00



## HAREKETLİ BORU KAPAMA ÇİFTLİ KİLİTLİ

Ürün Kodu	Kısa Kod	Yüzey	Ölçü	Fiyat
2769.021.00.B	31184	Beyaz	8x12x15 cm	100 40.00
2769.021.00.K	31185	Krom	8x12x15 cm	100 106.70



## SABİT HAVLUPAN ROZETİ

Ürün Kodu	Kısa Kod	Yüzey	Ölçü	Fiyat
2768.018.00.B	13540	Beyaz	Ø 2 -Ø7-4.5 cm	600 13.40
2768.018.00.K	13541	Krom	Ø 2 -Ø7-4.5 cm	600 30.00



## HAREKETLİ HAVLUPAN ROZETİ

Ürün Kodu	Kısa Kod	Yüzey	Ölçü	Fiyat
2769.020.00.B	31190	Beyaz	Ø 1.6 -Ø7-7 cm	600 16.70
2769.020.00.K	31191	Krom	Ø 1.6 -Ø7-7 cm	600 43.40



## HAREKETLİ HAVLUPAN ROZETİ

Ürün Kodu	Kısa Kod	Yüzey	Ölçü	Fiyat
2769.019.00.B	31192	Beyaz	Ø 2 -Ø7-10 cm	400 26.70
2769.019.00.K	31193	Krom	Ø 2 -Ø7-10 cm	400 53.40





**BELGE NUMARASI**  
REFERENCE NUMBER OF LICENCE 0264739-TSE-01/01

**BELGENİN İLK VERİLİŞ TARİHİ**  
DATE OF FIRST ISSUE OF LICENCE 03.12.2019

**BELGENİN SON GEÇERLİLİK TARİHİ**  
LICENCE VALID UNTIL 27.01.2023

**BELGE SAHİBİ KURULUŞUN ADI**  
NAME OF THE LICENCE HOLDER MERTİNOKS YAPI MALZEMELERİ SANAYİ VE TİCARET ANONİM ŞİRKETİ

**BELGE SAHİBİ KURULUŞUN ADRESİ**  
ADDRESS OF THE LICENCE HOLDER AKÇABURGAZ MAH. 3073. SK. /3 NO:4 ESENYURT İSTANBUL/TÜRKİYE

**ÜRETİM YERİ ADI**  
NAME OF THE MANUFACTURING PLACE MERTİNOKS YAPI MALZEMELERİ SAN.VE TİC.A.Ş.

**ÜRETİM YERİ ADRESİ**  
ADDRESS OF THE MANUFACTURING PLACE AKÇABURGAZ MAH.3073. SK. NO:4/3 ESENYURT İSTANBUL / TÜRKİYE

**İPTAL EDİLEN BELGE NUMARASI (Varsa)**  
INDICATION OF SUPERSEDED LICENCE (if any)

**TESCİLLİ TİCARİ MARKASI**  
REGISTERED TRADE MARK mertinox

**İLGİLİ TÜRK STANDARTI**  
RELATED TURKISH STANDARD TS 13865 / 29.04.2019

**BELGE KAPSAMI**  
SCOPE OF LICENCE

BANYO AKSESUARLARI  
Havluluk, Askılık, Klotzet Fırçalığı, Küvet Tutamağı, Tuvalet Kağıtlığı, Çöp Kovası

e-İmzalı/e-signed  
15.12.2021  
Belgelendirme Merkezi Başkanı Adına  
AHMET NURSI KARTAL  
TSE İSTANBUL BELGELENDİRME MÜDÜRÜ

\*Bu belge, belgelendiren öncün, üretim yerinin Enstitümüzün belirlediği şartlar karşılığına da geçerlidir.  
\*Bu belge, tic. bir amaçla kabul edilmez, kesin veya olumsuz bir ifadeyle kullanılmak üzere verilmemesi, kısıtlı ve dâhil yapılmaz.  
\*TSE İSTANBUL BELGELENDİRME MÜDÜRLÜĞÜ : Adres: Çayirova Tren İstasyonu Yanı ÇAYIROVA/GEBZE \* Telefon: 2627231273\* Faks: 2627231608  
\*TSE BELGELENDİRME MERKEZİ BAŞKANLIĞI : Adres: Necatibey Cad. No:112 06100 Bakırköy/İSTANBUL \* Telefon: 0 312 416 64 81 / 416 64 27, Faks: 0 312 416 66 17 E-posta: tseb@tse.org.tr, web : www.tse.org.tr

<https://evrakkontrol.tse.org.tr/BelgeDogrulama.aspx?pr=kkk049v> adresinden belgenin doğruluğunu ve geçerliliğini sorgulayınız



**BELGE NUMARASI**  
REFERENCE NUMBER OF LICENCE 0264739-TSE-04/01

**BELGENİN İLK VERİLİŞ TARİHİ**  
DATE OF FIRST ISSUE OF LICENCE 27.01.2021

**BELGENİN SON GEÇERLİLİK TARİHİ**  
LICENCE VALID UNTIL 27.01.2023

**BELGE SAHİBİ KURULUŞUN ADI**  
NAME OF THE LICENCE HOLDER MERTİNOKS YAPI MALZEMELERİ SANAYİ VE TİCARET ANONİM ŞİRKETİ

**BELGE SAHİBİ KURULUŞUN ADRESİ**  
ADDRESS OF THE LICENCE HOLDER AKÇABURGAZ MAH. 3073. SK. /3 NO:4 ESENYURT İSTANBUL/TÜRKİYE

**ÜRETİM YERİ ADI**  
NAME OF THE MANUFACTURING PLACE MERTİNOKS YAPI MALZEMELERİ SAN.VE TİC.A.Ş.

**ÜRETİM YERİ ADRESİ**  
ADDRESS OF THE MANUFACTURING PLACE AKÇABURGAZ MAH.3073. SK. NO:4/3 ESENYURT İSTANBUL / TÜRKİYE

**İPTAL EDİLEN BELGE NUMARASI (Varsa)**  
INDICATION OF SUPERSEDED LICENCE (if any)

**TESCİLLİ TİCARİ MARKASI**  
REGISTERED TRADE MARK maxiflow

**İLGİLİ TÜRK STANDARTI**  
RELATED TURKISH STANDARD TS EN 1253-2 / 18.02.2015

**BELGE KAPSAMI**  
SCOPE OF LICENCE

SIFONSUZ ZEMİN OLUKLARIN VE ÇATI SUYU TAHLİYE GİDERLERİ

-Yük Sınıfı K 3 Olan Plastik Gövde ve İzgaralı Zemin Olukları  
-Yük Sınıfı K 3 Olan Plastik Gövde ve Paslanmaz Çelik İzgaralı Zemin Olukları  
-Yük Sınıfı L 15 Olan Paslanmaz Çelik Gövdeli ve İzgaralı Zemin Olukları  
-Sifonlu ve Sifonsuz, Plastik Parapetler-Çatı Suyu Tahliyesi İçin

e-İmzalı/e-signed  
15.12.2021  
Belgelendirme Merkezi Başkanı Adına  
AHMET NURSI KARTAL  
TSE İSTANBUL BELGELENDİRME MÜDÜRÜ

\*Bu belge, belgelendiren öncün, üretim yerinin Enstitümüzün belirlediği şartlar karşılığına da geçerlidir.  
\*Bu belge, tic. bir amaçla kabul edilmez, kesin veya olumsuz bir ifadeyle kullanılmak üzere verilmemesi, kısıtlı ve dâhil yapılmaz.  
\*TSE İSTANBUL BELGELENDİRME MÜDÜRLÜĞÜ : Adres: Çayirova Tren İstasyonu Yanı ÇAYIROVA/GEBZE \* Telefon: 2627231273\* Faks: 2627231608  
\*TSE BELGELENDİRME MERKEZİ BAŞKANLIĞI : Adres: Necatibey Cad. No:112 06100 Bakırköy/İSTANBUL \* Telefon: 0 312 416 64 81 / 416 64 27, Faks: 0 312 416 66 17 E-posta: tseb@tse.org.tr, web : www.tse.org.tr

<https://evrakkontrol.tse.org.tr/BelgeDogrulama.aspx?pr=bpmskbfat> adresinden belgenin doğruluğunu ve geçerliliğini sorgulayınız



**BELGE NUMARASI**  
REFERENCE NUMBER OF LICENCE 0264739-TSE-03/01

**BELGENİN İLK VERİLİŞ TARİHİ**  
DATE OF FIRST ISSUE OF LICENCE 27.01.2021

**BELGENİN SON GEÇERLİLİK TARİHİ**  
LICENCE VALID UNTIL 27.01.2023

**BELGE SAHİBİ KURULUŞUN ADI**  
NAME OF THE LICENCE HOLDER MERTİNOKS YAPI MALZEMELERİ SANAYİ VE TİCARET ANONİM ŞİRKETİ

**BELGE SAHİBİ KURULUŞUN ADRESİ**  
ADDRESS OF THE LICENCE HOLDER AKÇABURGAZ MAH. 3073. SK. /3 NO:4 ESENYURT İSTANBUL/TÜRKİYE

**ÜRETİM YERİ ADI**  
NAME OF THE MANUFACTURING PLACE MERTİNOKS YAPI MALZEMELERİ SAN.VE TİC.A.Ş.

**ÜRETİM YERİ ADRESİ**  
ADDRESS OF THE MANUFACTURING PLACE AKÇABURGAZ MAH.3073. SK. NO:4/3 ESENYURT İSTANBUL / TÜRKİYE

**İPTAL EDİLEN BELGE NUMARASI (Varsa)**  
INDICATION OF SUPERSEDED LICENCE (if any)

**TESCİLLİ TİCARİ MARKASI**  
REGISTERED TRADE MARK maxiflow

**İLGİLİ TÜRK STANDARTI**  
RELATED TURKISH STANDARD TS EN 1253-1 / 18.02.2015

**BELGE KAPSAMI**  
SCOPE OF LICENCE

SIFONLU ZEMİN OLUKLARI  
-Alt Çıkış Membranlı veya Membransız  
Plastik; Sınıf A, K 3  
-Alt Çıkış Membransız  
Plastik; Sınıf A, H 1,5, K3, L15  
-Yan Çıkış Membranlı  
Plastik; Sınıf A, K 3  
-Yan Çıkış Membransız  
Plastik; Sınıf A, K 3, L15  
-Alt veya Yan Çıkışlı, Membranlı  
Plastik&Metal; Sınıf A, K 3  
-Yan Çıkış Membranlı veya Membransız  
Plastik&Metal; Sınıf A, K 3

e-İmzalı/e-signed  
15.12.2021  
Belgelendirme Merkezi Başkanı Adına  
AHMET NURSI KARTAL  
TSE İSTANBUL BELGELENDİRME MÜDÜRÜ

\*Bu belge, belgelendiren öncün, üretim yerinin Enstitümüzün belirlediği şartlar karşılığına da geçerlidir.  
\*Bu belge, tic. bir amaçla kabul edilmez, kesin veya olumsuz bir ifadeyle kullanılmak üzere verilmemesi, kısıtlı ve dâhil yapılmaz.  
\*TSE İSTANBUL BELGELENDİRME MÜDÜRLÜĞÜ : Adres: Çayirova Tren İstasyonu Yanı ÇAYIROVA/GEBZE \* Telefon: 2627231273\* Faks: 2627231608  
\*TSE BELGELENDİRME MERKEZİ BAŞKANLIĞI : Adres: Necatibey Cad. No:112 06100 Bakırköy/İSTANBUL \* Telefon: 0 312 416 64 81 / 416 64 27, Faks: 0 312 416 66 17 E-posta: tseb@tse.org.tr, web : www.tse.org.tr

<https://evrakkontrol.tse.org.tr/BelgeDogrulama.aspx?pr=iy09v> adresinden belgenin doğruluğunu ve geçerliliğini sorgulayınız



**BELGE NUMARASI**  
REFERENCE NUMBER OF LICENCE 0264739-TSE-02/01

**BELGENİN İLK VERİLİŞ TARİHİ**  
DATE OF FIRST ISSUE OF LICENCE 03.12.2019

**BELGENİN SON GEÇERLİLİK TARİHİ**  
LICENCE VALID UNTIL 27.01.2023

**BELGE SAHİBİ KURULUŞUN ADI**  
NAME OF THE LICENCE HOLDER MERTİNOKS YAPI MALZEMELERİ SANAYİ VE TİCARET ANONİM ŞİRKETİ

**BELGE SAHİBİ KURULUŞUN ADRESİ**  
ADDRESS OF THE LICENCE HOLDER AKÇABURGAZ MAH. 3073. SK. /3 NO:4 ESENYURT İSTANBUL/TÜRKİYE

**ÜRETİM YERİ ADI**  
NAME OF THE MANUFACTURING PLACE MERTİNOKS YAPI MALZEMELERİ SAN.VE TİC.A.Ş.

**ÜRETİM YERİ ADRESİ**  
ADDRESS OF THE MANUFACTURING PLACE AKÇABURGAZ MAH.3073. SK. NO:4/3 ESENYURT İSTANBUL / TÜRKİYE

**İPTAL EDİLEN BELGE NUMARASI (Varsa)**  
INDICATION OF SUPERSEDED LICENCE (if any)

**TESCİLLİ TİCARİ MARKASI**  
REGISTERED TRADE MARK mertinox

**İLGİLİ TÜRK STANDARTI**  
RELATED TURKISH STANDARD TS 13735 / 06.02.2017

**BELGE KAPSAMI**  
SCOPE OF LICENCE

Çöp Kovası-Ç ve Dış Mekanlarda Kullanılan

e-İmzalı/e-signed  
15.12.2021  
Belgelendirme Merkezi Başkanı Adına  
AHMET NURSI KARTAL  
TSE İSTANBUL BELGELENDİRME MÜDÜRÜ

\*Bu belge, belgelendiren öncün, üretim yerinin Enstitümüzün belirlediği şartlar karşılığına da geçerlidir.  
\*Bu belge, tic. bir amaçla kabul edilmez, kesin veya olumsuz bir ifadeyle kullanılmak üzere verilmemesi, kısıtlı ve dâhil yapılmaz.  
\*TSE İSTANBUL BELGELENDİRME MÜDÜRLÜĞÜ : Adres: Çayirova Tren İstasyonu Yanı ÇAYIROVA/GEBZE \* Telefon: 2627231273\* Faks: 2627231608  
\*TSE BELGELENDİRME MERKEZİ BAŞKANLIĞI : Adres: Necatibey Cad. No:112 06100 Bakırköy/İSTANBUL \* Telefon: 0 312 416 64 81 / 416 64 27, Faks: 0 312 416 66 17 E-posta: tseb@tse.org.tr, web : www.tse.org.tr

<https://evrakkontrol.tse.org.tr/BelgeDogrulama.aspx?pr=kbar7fd> adresinden belgenin doğruluğunu ve geçerliliğini sorgulayınız



# NOTLAR

A series of horizontal dashed lines for writing notes.







Akçaburgaz Mahallesi 3073 Sokak  
No: 4/3-4 Esenyurt - İSTANBUL



Tel :0(212) 617 28 22

Fax :0(212) 617 28 52



[export@mertinoks.com](mailto:export@mertinoks.com)

[satis@mertinoks.com](mailto:satis@mertinoks.com)

Turkey

ISO  
9001-2008

CE